

## Excellent Integrated System Limited

Stocking Distributor

Click to view price, real time Inventory, Delivery & Lifecycle Information:

[Molex Connector Corporation](#)  
[54363-0578](#)

For any questions, you can email us directly:

[sales@integrated-circuit.com](mailto:sales@integrated-circuit.com)

DWG. NO. SD-54363-038

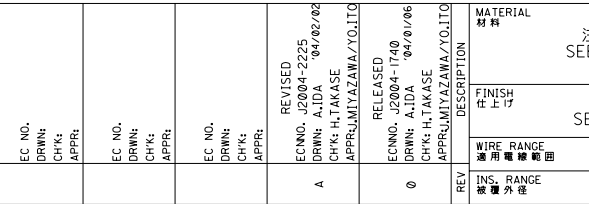
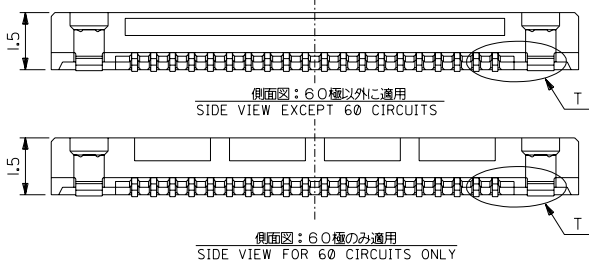
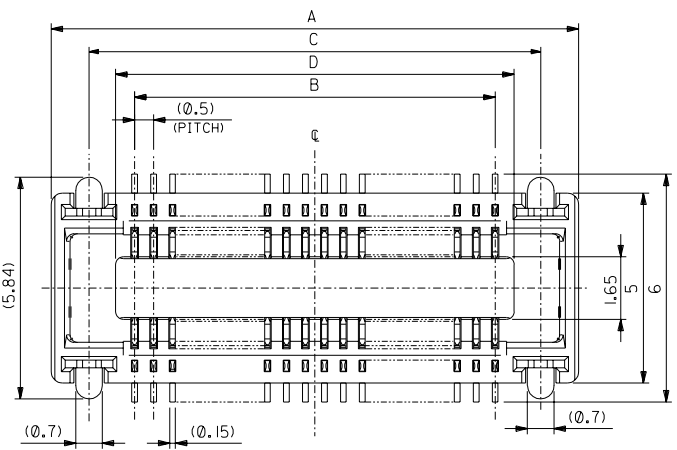

注記 NOTES:

- 材質 MATERIAL  
ハウジング: LCP (液晶ポリマー), ガラス充填, 黒色, UL 94 V-0  
HOUSING: LCP (LIQUID CRYSTAL POLYMER), GLASS FILLED, BLACK, UL94V-0  
ターミナル: 銅合金 (t=0.15)  
TERMINAL: COPPER ALLOY (t=0.15)  
ネイル: 銅合金 (t=0.2)  
NAIL: COPPER ALLOY (t=0.2)
- メッキ仕様 PLATING  
ターミナル TERMINAL  
接点部: 金メッキ 0.25 マイクロメートル以上  
CONTACT AREA: GOLD 0.25 MICROMETER MINIMUM  
半田付部分: 金メッキ 0.4 マイクロメートル以下  
SOLDER TAIL AREA: GOLD 0.4 MICROMETER MAXIMUM  
下地メッキ: ニッケルメッキ 1.5 マイクロメートル以上  
UNDER PLATING: NICKEL 1.5 MICROMETER MINIMUM  
ネイル NAIL  
銅メッキ 3.0 マイクロメートル以上  
Sn 3.0 MICROMETER MINIMUM  
下地メッキ: ニッケルメッキ 1.0 マイクロメートル以上  
UNDER PLATING: Ni 1.0 MICROMETER MINIMUM
- テール平坦度は、0.08 ミリメートル以下。テールとネイルを併せた平坦度は、0.1 ミリメートル以下。  
TAIL COPPLANARITY TO BE 0.08 MAXIMUM, TAILS AND NAILS COPPLANARITY TO BE 0.1 MAXIMUM.
- 嵌合相手: 55299-\*\*\* (H=3mm)  
: 55201-\*\*\*, 55650-\*\*\* (H=2mm)  
MATED CONN.: 55299-\*\*\* (H=3mm)  
: 55201-\*\*\*, 55650-\*\*\* (H=2mm)
- この製品は 54363-\*\*\*01, (エンボス梱包品 54363-\*\*\*08) の姉妹製品です。  
THIS PRODUCT IS 'LEAD FREE' OF 54363-\*\*\*01, (EMBOSSED TAPE PKG 54363-\*\*\*08)

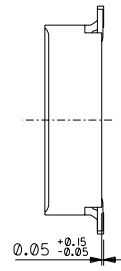

40.5	41.9	39.5	43.9	54363-1678	54363-1671	160	—
35.5	36.9	34.5	38.9	54363-1478	54363-1471	140	○
30.5	31.9	29.5	33.9	54363-1278	54363-1271	120	○
28	29.4	27	31.4	54363-1178	54363-1171	110	○
25.5	26.9	24.5	28.9	54363-1078	54363-1071	100	○
23	24.4	22	26.4	54363-0978	54363-0971	90	—
20.5	21.9	19.5	23.9	54363-0878	54363-0871	80	○
18	19.4	17	21.4	54363-0778	54363-0771	70	○
15.5	16.9	14.5	18.9	54363-0678	54363-0671	60	○
13	14.4	12	16.4	54363-0578	54363-0571	50	○
10.5	11.9	9.5	13.9	54363-0478	54363-0471	40	○
8	9.4	7	11.4	54363-0378	54363-0371	30	○
5.5	6.9	4.5	8.9	54363-0278	54363-0271	20	○

D	C	B	A	エンボス梱包品 EMBOSSED TAPE PACKAGING	製品番号 MATERIAL NO.	極数 CIRCUITS	量産対応 AVAILABLE

DO NOT SCALE DRAWING

EC NO. DRWN: CHK: APPR:	EC NO. DRWN: CHK: APPR:	EC NO. DRWN: CHK: APPR:	REVISED ECNNO. J2004-2225 DRWN: A.IDA '04/02/02 CHK: H.TAKASE APPR: MITAZAWA/YO.ITO	RELEASED ECNNO. J2004-1740 DRWN: A.IDA '04/01/06 CHK: H.TAKASE APPR: MIYAZAWA/YO.ITO	MATERIAL 材料 注記参照 SEE NOTES	FINISH 仕上り 注記参照 SEE NOTES	WIRE RANGE 適用電線範囲	INS. RANGE 被覆外径
----------------------------------	----------------------------------	----------------------------------	---	--	-------------------------------------	------------------------------------	----------------------	--------------------

GENERAL TOLERANCES: (UNLESS SPECIFIED) 一般公差	SCALE 10-1	DESIGN UNITS mm INCH	THIRD ANGLE PROJECTION	DIMENSIONS: mm INCH mm INCH mm ONLY	SHT REV
10 UNDER 未満		DRAWN BY & DATE A. Iida '04/01/06	☉	mm INCH mm ONLY	REVISE ON CAD ONLY
10 OVER 以上	30 UNDER 未満	CHECKED BY & DATE S. Takase '04/01/06		TITLE: 0.5 mm PITCH B/B CONN. REC. HOUSING ASS'Y (H=2,3mm) WITH FITTING NAIL -LEAD FREE-	
30 OVER 以上		APPROVED BY & DATE S. Takase '04/01/06		MOLEX INCORPORATED	
ANGLE 角度		CAD FILENAME SD-54363-038.S01		MATERIAL NO. SEE CHART	
				DRAWING NO. SD-54363-038	SHEET NO. 1 OF 2
					SIZE B
					EN-02J(097) MXJ-54

F  
E  
D  
C  
B  
A



DWG. NO. SD-54363-039

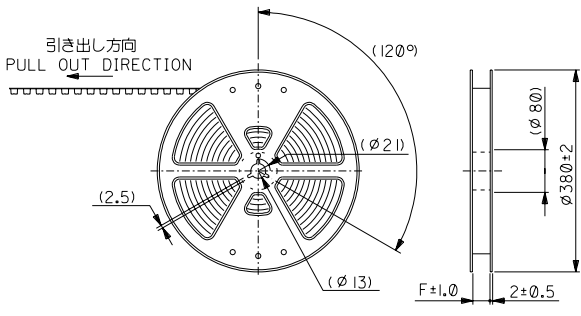

注) NOTES

1. 製品番号54363-\*\*71 詳細寸法については、製品単体図面を参照下さい。  
IN THE PACKAGE PART NUMBER: 54363-\*\*71 DETAILED DIMENSIONS, SEE SALES DRAWING FOR CONNECTOR.
2. 梱包数量: 2500個/リール  
NUMBER OF CONNECTORS: 2500 PCS/REEL.
3. リードテープ長さ  
LEAD TAPE LENGTH

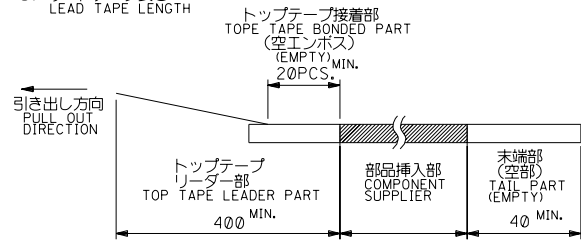

4. トップテープの剥離強度: (剥離方向は下図参照)  
PEELING OFF FORCE OF TOP TAPE (PELLING DIRECTION AS SHOWN IN FOLLOWING FIGURE)  
0.1~1.3N (10~130gf)

尚、本規格値は、出荷時に適用。  
THIS REQUIREMENT SHOULD BE APPLIED AT SHIPMENT.  
(但し、輸送時に剥離が発生しない事。)  
(PEEL OFF SHOULD NOT BE ALLOWED, DURING TRANSPORTATION.)

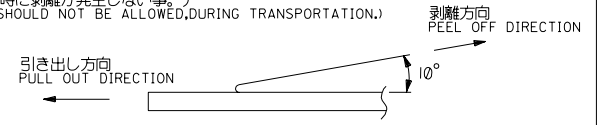

5. 材料  
MATERIAL  
キャリアテープ: ポリプロピレン (PP)  
CARRIER TAPE: POLYPROPYLENE (PP)  
トップテープ: PET, PE, PEF  
TOP TAPE: PET, PE, PEF  
リール: ポリスチレン  
REEL: POLYSTYRENE
6. この製品は54363-\*\*01, (エンボス梱包品 54363-\*\*08) の鉛フリー品です。  
THIS PRODUCT IS 'LEAD FREE' OF 54363-\*\*01, (EMBOSSED TAPE PKG 54363-\*\*08)

DO NOT SCALE DRAWING

EC NO. DRAWN: CHK: APPR:	EC NO. DRAWN: CHK: APPR:	EC NO. DRAWN: CHK: APPR:	REVISED	MATERIAL 材料	GENERAL TOLERANCES: (UNLESS SPECIFIED) 一般公差	SCALE NONE	DESIGN UNITS mm INCH	THIRD ANGLE PROJECTION	DIMENSIONS: mm INCH mm INCH mm ONLY	SHT REV	REVISE ON CAD ONLY
			ECNN: J2004-2225 DRAWN: A.IDA '04/02/02 CHK: H.TAKASE APPR: MITAZAWA/YO.ITO								
A	0	6	RELEASED	FINISH 仕上げ	ANGLE 角度	+3°	APPROVED BY & DATE S. Iida 04/01/06	MATERIAL NO. SEE CHART	DRAWING NO. SD-54363-039	SHEET NO. 1 OF 2	SIZE B
			ECNN: J2004-1740 DRAWN: A.IDA '04/01/06 CHK: H.TAKASE APPR: MIYAZAWA/YO.ITO								
8	7	6	REV	INS. RANGE 検査外径			CAD FILENAME SD-54363-039.S01	MATERIAL NO. SEE CHART	DRAWING NO. SD-54363-039	SHEET NO. 1 OF 2	SIZE B

