

Excellent Integrated System Limited

Stocking Distributor

Click to view price, real time Inventory, Delivery & Lifecycle Information:

[Fairchild Semiconductor](#)
[MMBD6050](#)

For any questions, you can email us directly:

sales@integrated-circuit.com



April 2007

MMBD6050

Small Signal Diode

Connection Diagram

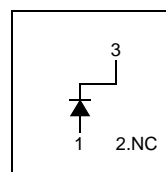
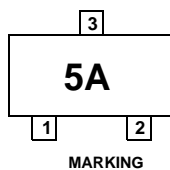
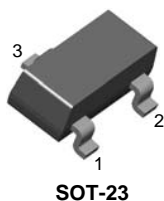

Absolute Maximum Ratings * $T_A = 25^\circ\text{C}$ unless otherwise noted

Symbol	Parameter	Value	Units
V_{RRM}	Maximum Repetitive Reverse Voltage	70	V
$I_{F(AV)}$	Average Rectified Forward Current	200	mA
I_{FSM}	Non-repetitive Peak Forward Surge Current		
	Pulse Width = 1.0 second	1.0	A
	Pulse Width = 1.0 microsecond	2.0	A
T_{STG}	Storage Temperature Range	-55 to +150	$^\circ\text{C}$
T_J	Operating Junction Temperature	-55 to +150	$^\circ\text{C}$

* These ratings are limiting values above which the serviceability of the diode may be impaired.

NOTES:

- 1) These ratings are based on a maximum junction temperature of 150 degrees C.
- 2) These are steady limits. The factory should be consulted on applications involving pulsed or low duty cycle operations.

Thermal Characteristics

Symbol	Parameter	Value	Units
P_D	Power Dissipation	350	mW
$R_{\theta JA}$	Thermal Resistance, Junction to Ambient	357	$^\circ\text{C}/\text{W}$

Electrical Characteristics $T_A = 25^\circ\text{C}$ unless otherwise noted

Symbol	Parameter	Test Conditions	Min.	Max.	Units
V_R	Breakdown Voltage	$I_R = 100\mu\text{A}$	70		V
V_F	Forward Voltage	$I_F = 1\text{mA}$	0.55	0.7	V
		$I_F = 100\text{mA}$	0.85	1.1	
I_R	Reverse Leakage	$V_R = 50\text{V}$		100	nA
C_T	Total Capacitance	$V_R = 0\text{V}, f = 1.0\text{MHz}$		2.5	pF
t_{rr}	Reverse Recovery Time	$I_F = I_R = 10\text{mA}, I_{RR} = 1.0\text{mA}, R_L = 100\Omega$		4.0	ns

Typical Performance Characteristics

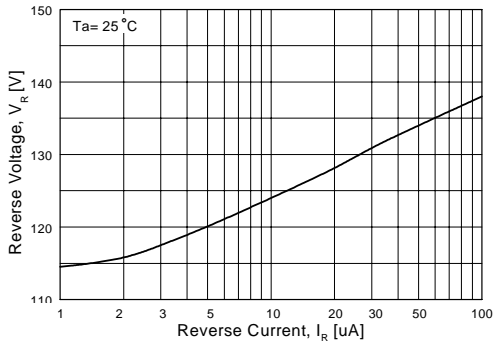

Figure 1. Reverse Voltage vs Reverse Current
BV - 1.0 to 100 μ A

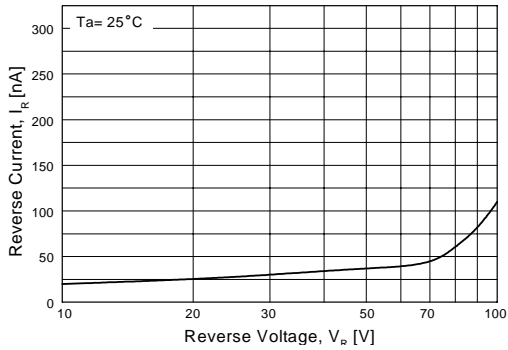

Figure 2. Reverse Current vs Reverse Voltage
IR - 10 to 100 V

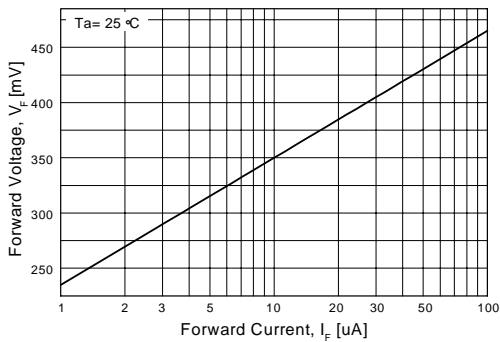

Figure 3. Forward Voltage vs Forward Current
VF - 1.0 to 100 μ A

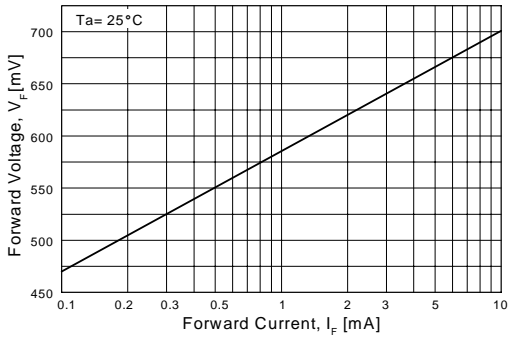

Figure 4. Forward Voltage vs Forward Current
VF - 0.1 to 10 mA

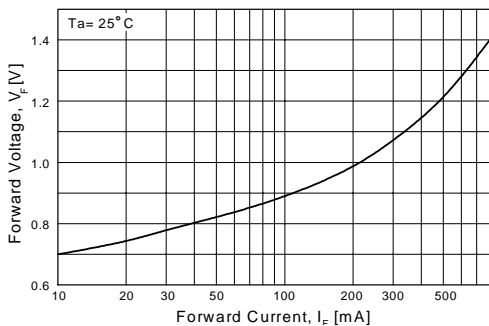

Figure 5. Forward Voltage vs Forward Current
VF - 10 - 800 mA

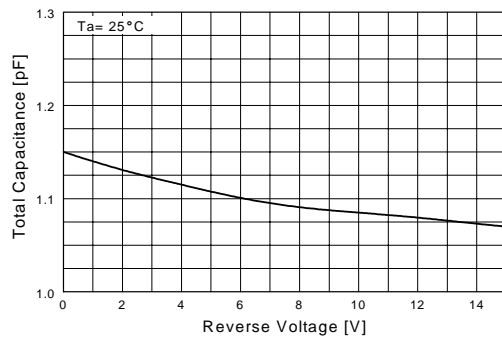

Figure 6. Total Capacitance vs Reverse Voltage

Typical Performance Characteristics (Continued)

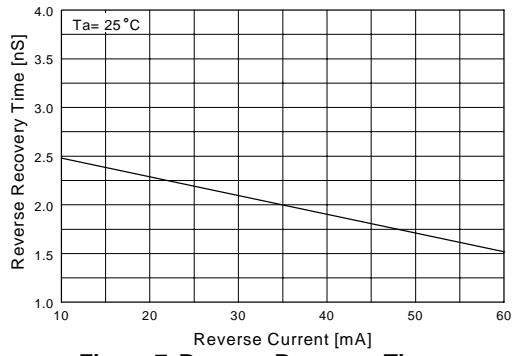

Figure 7. Reverse Recovery Time vs Reverse Current
 TRR - IR 10 mA vs 60 mA

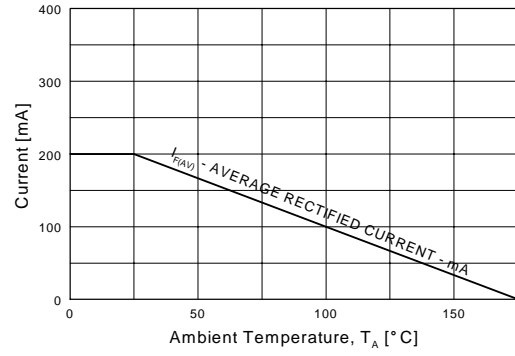
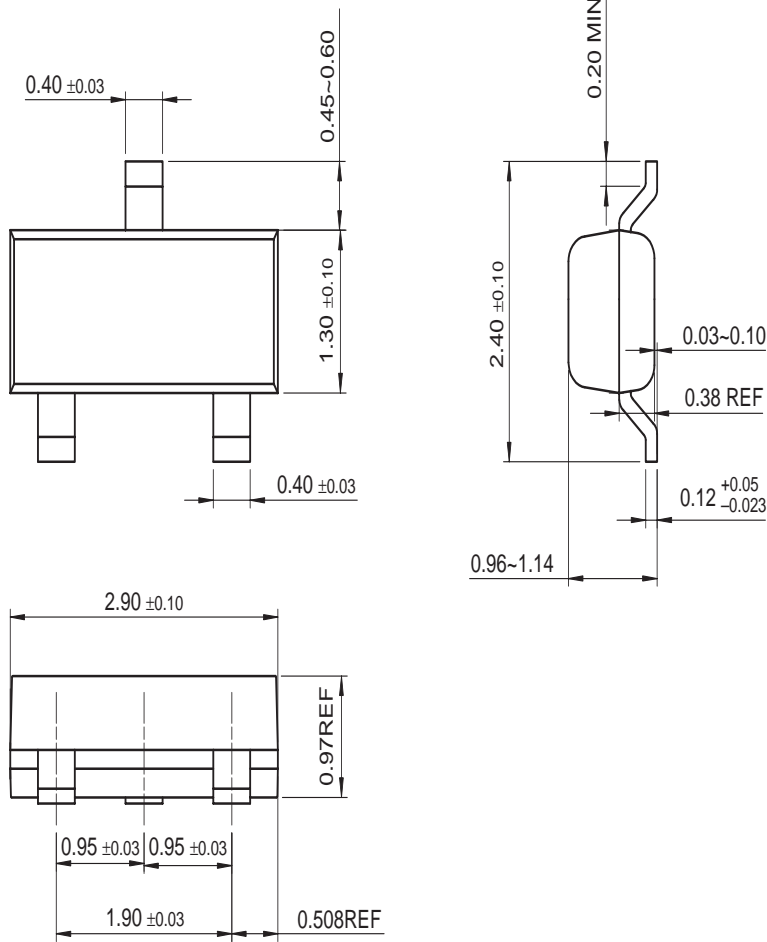

Figure 8. Average Rectified Current ($I_{F(AV)}$) versus Ambient Temperature (T_A)

Mechanical Dimensions

SOT-23





TRADEMARKS

The following are registered and unregistered trademarks Fairchild Semiconductor owns or is authorized to use and is not intended to be an exhaustive list of all such trademarks.

ACE _x TM	GTO TM	PowerSaver TM	TinyBuck TM
Across the board. Around the world. TM	HiSeC TM	PowerTrench [®]	TinyLogic [®]
ActiveArray TM	<i>i-Lo</i> TM	Programmable Active Droop TM	TINYOPTO TM
Bottomless TM	ImpliedDisconnect TM	QFET [®]	TinyPower TM
Build it Now TM	IntelliMAX TM	QS TM	TinyWire TM
CoolFET TM	ISOPLANAR TM	QT Optoelectronics TM	TruTranslation TM
CROSSVOLT TM	MICROCOUPLER TM	Quiet Series TM	μSerDes TM
CTL TM	MicroPak TM	RapidConfigure TM	UHC [®]
Current Transfer Logic TM	MICROWIRE TM	RapidConnect TM	UniFET TM
DOME TM	MSX TM	ScalarPump TM	VCX TM
E ² CMOS TM	MSXPro TM	SMART START TM	Wire TM
EcoSPARK [®]	OCX TM	SPM TM	
EnSigna TM	OCXPro TM	SuperFET TM	
FACT Quiet Series TM	OPTOLOGIC [®]	SuperSOT TM -3	
FACT [®]	OPTOPLANAR TM [®]	SuperSOT TM -6	
FAST [®]	PACMAN TM	SuperSOT TM -8	
FAST _r TM	POP TM	TCM TM	
FPS TM	Power220 [®]	The Power Franchise [®]	
FRFET TM	Power247 [®]	TinyBoost TM	
GlobalOptoisolator TM	PowerEdge TM		

DISCLAIMER

FAIRCHILD SEMICONDUCTOR RESERVES THE RIGHT TO MAKE CHANGES WITHOUT FURTHER NOTICE TO ANY PRODUCTS HEREIN TO IMPROVE RELIABILITY, FUNCTION OR DESIGN. FAIRCHILD DOES NOT ASSUME ANY LIABILITY ARISING OUT OF THE APPLICATION OR USE OF ANY PRODUCT OR CIRCUIT DESCRIBED HEREIN; NEITHER DOES IT CONVEY ANY LICENSE UNDER ITS PATENT RIGHTS, NOR THE RIGHTS OF OTHERS. THESE SPECIFICATIONS DO NOT EXPAND THE TERMS OF FAIRCHILD'S WORLDWIDE TERMS AND CONDITIONS. SPECIFICALLY THE WARRANTY THEREIN, WHICH COVERS THESE PRODUCTS.

LIFE SUPPORT POLICY

FAIRCHILD'S PRODUCTS ARE NOT AUTHORIZED FOR USE AS CRITICAL COMPONENTS IN LIFE SUPPORT DEVICES OR SYSTEMS WITHOUT THE EXPRESS WRITTEN APPROVAL OF FAIRCHILD SEMICONDUCTOR CORPORATION.

As used herein:

- Life support devices or systems are devices or systems which, (a) are intended for surgical implant into the body, or (b) support or sustain life, or (c) whose failure to perform when properly used in accordance with instructions for use provided in the labeling, can be reasonably expected to result in significant injury to the user.
- A critical component is any component of a life support device or system whose failure to perform can be reasonably expected to cause the failure of the life support device or system, or to affect its safety or effectiveness.

PRODUCT STATUS DEFINITIONS

Definition of Terms

Datasheet Identification	Product Status	Definition
Advance Information	Formative or In Design	This datasheet contains the design specifications for product development. Specifications may change in any manner without notice.
Preliminary	First Production	This datasheet contains preliminary data, and supplementary data will be published at a later date. Fairchild Semiconductor reserves the right to make changes at any time without notice in order to improve design.
No Identification Needed	Full Production	This datasheet contains final specifications. Fairchild Semiconductor reserves the right to make changes at any time without notice in order to improve design.
Obsolete	Not In Production	This datasheet contains specifications on a product that has been discontinued by Fairchild semiconductor. The datasheet is printed for reference information only.

Rev. I23