

Excellent Integrated System Limited

Stocking Distributor

Click to view price, real time Inventory, Delivery & Lifecycle Information:

[Fairchild Semiconductor](#)
[KSD794AYSTU](#)

For any questions, you can email us directly:

sales@integrated-circuit.com



KSD794/794A

Audio Frequency Power Amplifier

- Complement to KSB744/KSB744A

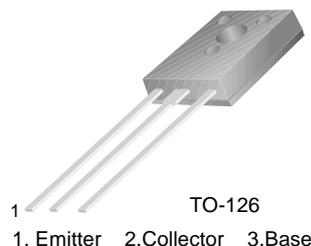

NPN Epitaxial Silicon Transistor

Absolute Maximum Ratings $T_C=25^\circ\text{C}$ unless otherwise noted

Symbol	Parameter	Value	Units
V_{CBO}	Collector- Base Voltage	70	V
V_{CEO}	Collector-Emitter Voltage	45 60	V V
		: KSD794 : KSD794A	
V_{EBO}	Emitter- Base Voltage	5	V
I_C	Collector Current (DC)	3	A
I_{CP}	*Collector Current (Pulse)	5	A
I_B	Base Current (DC)	0.6	A
P_C	Collector Dissipation ($T_a=25^\circ\text{C}$)	1	W
P_C	Collector Dissipation ($T_C=25^\circ\text{C}$)	10	W
T_J	Junction Temperature	150	$^\circ\text{C}$
T_{STG}	Storage Temperature	- 55 ~ 150	$^\circ\text{C}$

* $PW \leq 10\text{ms}$, Duty Cycle $\leq 50\%$

Electrical Characteristics $T_C=25^\circ\text{C}$ unless otherwise noted

Symbol	Parameter	Test Condition	Min.	Typ.	Max.	Units
I_{CBO}	Collector Cut-off Current	$V_{CB} = 45\text{V}, I_E = 0$			1	μA
I_{EBO}	Emitter Cut-off Current	$V_{EB} = 3\text{V}, I_C = 0$			1	μA
h_{FE1} h_{FE2}	* DC Current Gain	$V_{CE} = 5\text{V}, I_C = 20\text{mA}$ $V_{CE} = 5\text{V}, I_C = 0.5\text{A}$	30 60	70 100	320	
$V_{CE}(\text{Sat})$	* Collector-Emitter Saturation Voltage	$I_C = 1.5\text{A}, I_B = 0.15\text{A}$		0.3	2	V
$V_{BE}(\text{Sat})$	* Base-Emitter Saturation Voltage	$I_C = 1.5\text{A}, I_B = 0.15\text{A}$		0.8	2	V
f_T	Current Gain Bandwidth Product	$V_{CE} = 5\text{V}, I_E = 0.1\text{A}$		60		MHz
C_{ob}	Output Capacitance	$V_{CB} = 10\text{V}, I_E = 0, f = 1\text{MHz}$		40		pF

* Pulse Test: $PW \leq 350\mu\text{s}$, Duty Cycle $\leq 2\%$ Pulsed

h_{FE} Classification

Classification	R	O	Y
h_{FE2}	60 ~ 120	100 ~ 200	160 ~ 320

Typical Characteristics

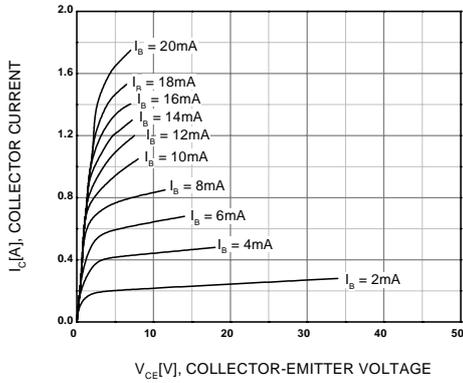

Figure 1. Static Characteristic

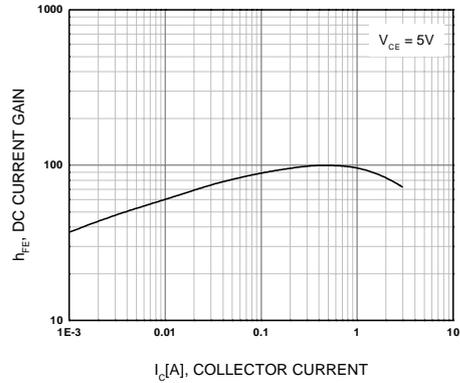
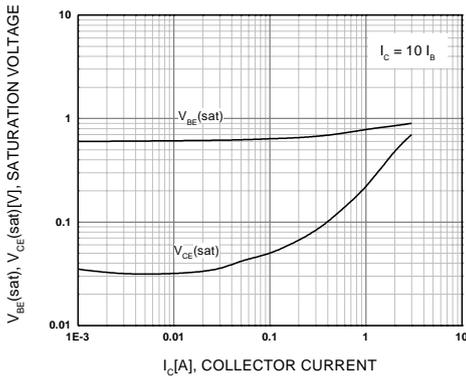

Figure 2. DC current Gain



**Figure 3. Base-Emitter Saturation Voltage
Collector-Emitter Saturation Voltage**

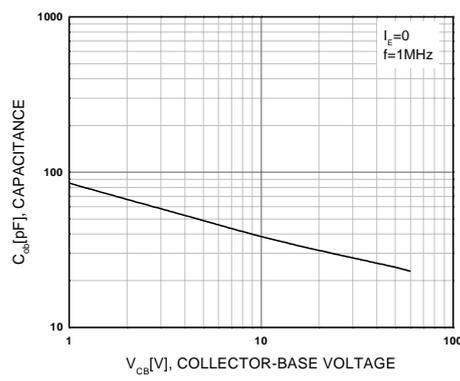

Figure 4. Collector Output Capacitance

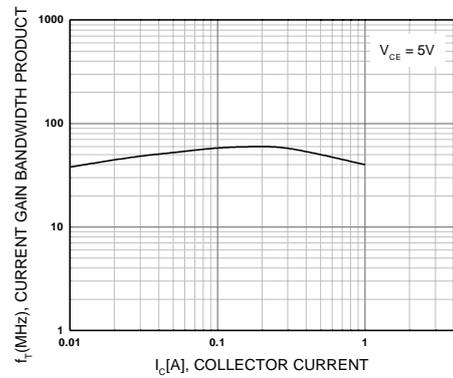

Figure 5. Current Gain Bandwidth Product

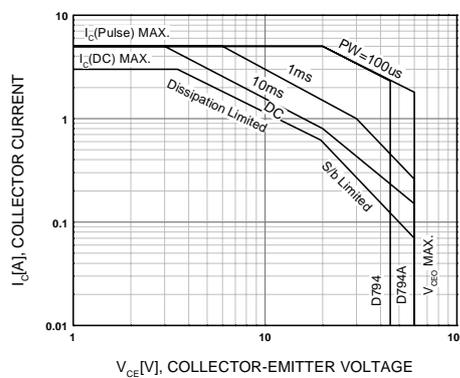

Figure 6. Safe Operating Area

Typical Characteristics (Continued)

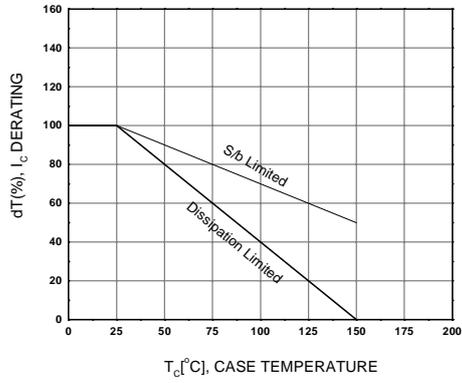

Figure 7. Derating Curve Of Safe Operating Areas

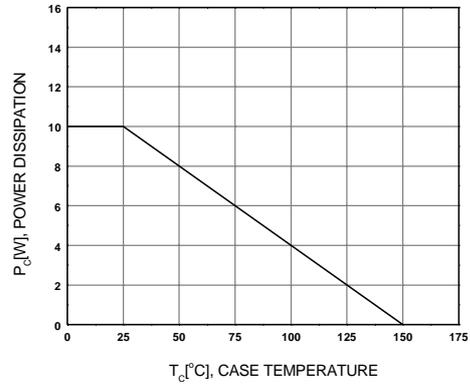
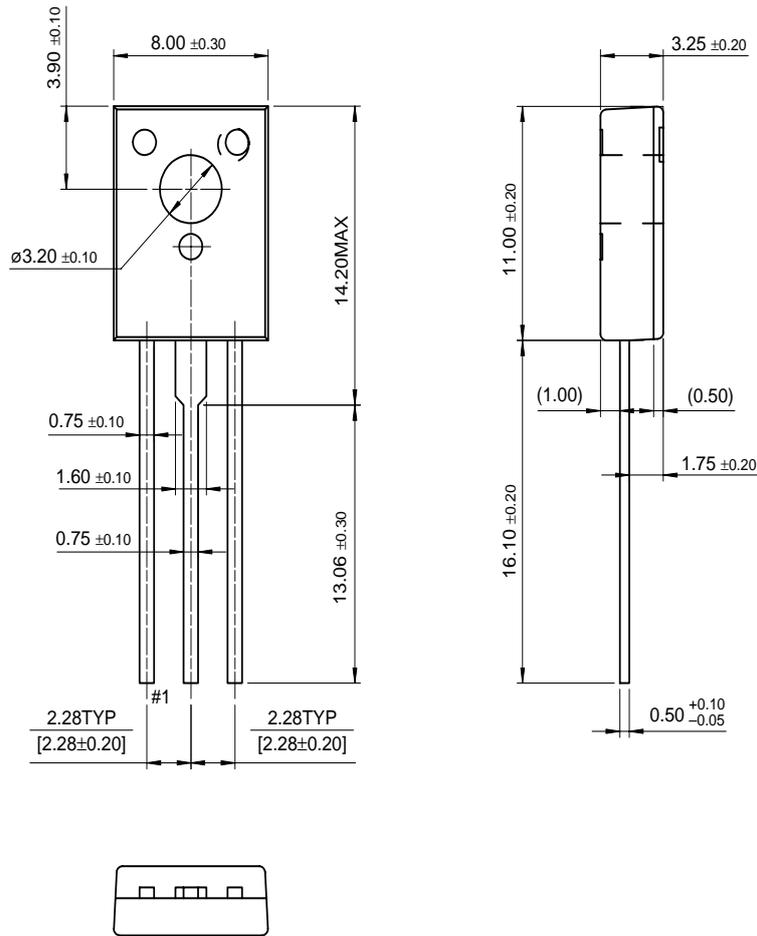

Figure 8. Power Derating

Package Dimensions

TO-126



Dimensions in Millimeters

TRADEMARKS

The following are registered and unregistered trademarks Fairchild Semiconductor owns or is authorized to use and is not intended to be an exhaustive list of all such trademarks.

ACE ^x TM	FAST [®]	OPTOPLANAR TM	STAR*POWER TM
Bottomless TM	FAST ^r TM	PACMAN TM	Stealth TM
CoolFET TM	FRFET TM	POP TM	SuperSOT TM -3
CROSSVOLT TM	GlobalOptoisolator TM	Power247 TM	SuperSOT TM -6
DenseTrench TM	GTO TM	PowerTrench [®]	SuperSOT TM -8
DOMET TM	HiSeC TM	QFET TM	SyncFET TM
EcoSPARK TM	ISOPLANAR TM	QS TM	TruTranslation TM
E ² CMOS TM	LittleFET TM	QT Optoelectronics TM	TinyLogic TM
EnSigna TM	MicroFET TM	Quiet Series TM	UHC TM
FACT TM	MICROWIRE TM	SLIENT SWITCHER [®]	UltraFET [®]
FACT Quiet Series TM	OPTOLOGIC TM	SMART START TM	VCX TM

STAR*POWER is used under license

DISCLAIMER

FAIRCHILD SEMICONDUCTOR RESERVES THE RIGHT TO MAKE CHANGES WITHOUT FURTHER NOTICE TO ANY PRODUCTS HEREIN TO IMPROVE RELIABILITY, FUNCTION OR DESIGN. FAIRCHILD DOES NOT ASSUME ANY LIABILITY ARISING OUT OF THE APPLICATION OR USE OF ANY PRODUCT OR CIRCUIT DESCRIBED HEREIN; NEITHER DOES IT CONVEY ANY LICENSE UNDER ITS PATENT RIGHTS, NOR THE RIGHTS OF OTHERS.

LIFE SUPPORT POLICY

FAIRCHILD'S PRODUCTS ARE NOT AUTHORIZED FOR USE AS CRITICAL COMPONENTS IN LIFE SUPPORT DEVICES OR SYSTEMS WITHOUT THE EXPRESS WRITTEN APPROVAL OF FAIRCHILD SEMICONDUCTOR CORPORATION.

As used herein:

1. Life support devices or systems are devices or systems which, (a) are intended for surgical implant into the body, or (b) support or sustain life, or (c) whose failure to perform when properly used in accordance with instructions for use provided in the labeling, can be reasonably expected to result in significant injury to the user.
2. A critical component is any component of a life support device or system whose failure to perform can be reasonably expected to cause the failure of the life support device or system, or to affect its safety or effectiveness.

PRODUCT STATUS DEFINITIONS

Definition of Terms

Datasheet Identification	Product Status	Definition
Advance Information	Formative or In Design	This datasheet contains the design specifications for product development. Specifications may change in any manner without notice.
Preliminary	First Production	This datasheet contains preliminary data, and supplementary data will be published at a later date. Fairchild Semiconductor reserves the right to make changes at any time without notice in order to improve design.
No Identification Needed	Full Production	This datasheet contains final specifications. Fairchild Semiconductor reserves the right to make changes at any time without notice in order to improve design.
Obsolete	Not In Production	This datasheet contains specifications on a product that has been discontinued by Fairchild semiconductor. The datasheet is printed for reference information only.