

Excellent Integrated System Limited

Stocking Distributor

Click to view price, real time Inventory, Delivery & Lifecycle Information:

[NKK Switches](#)
[UB225KKG01CF-1JB](#)

For any questions, you can email us directly:
sales@integrated-circuit.com

TYPICAL SWITCH ORDERING EXAMPLE

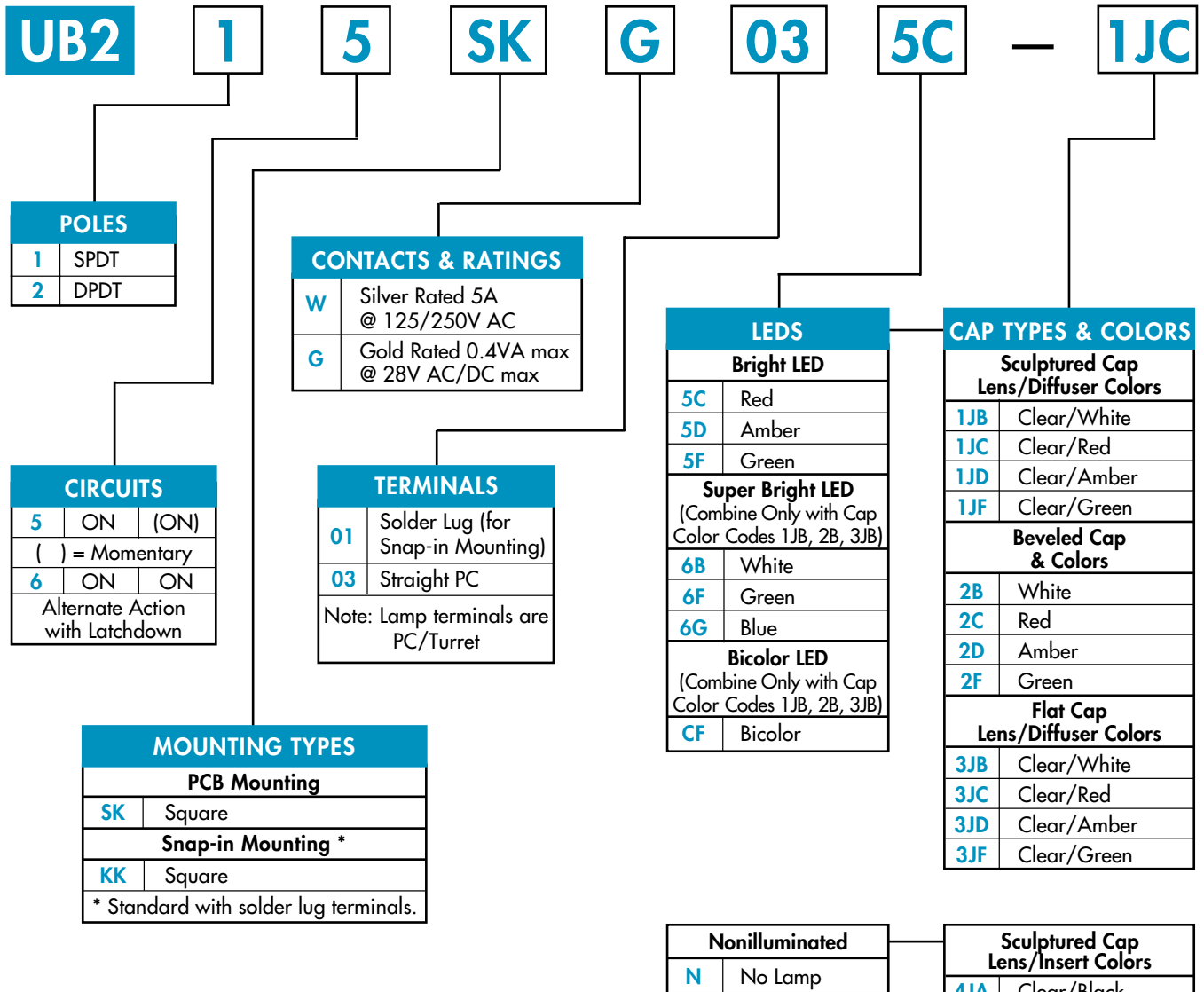

DESCRIPTION FOR TYPICAL ORDERING EXAMPLE

UB215SKG035C-1JC

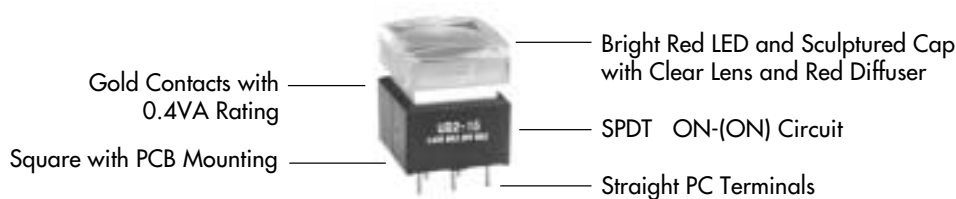

GENERAL SPECIFICATIONS

Electrical Capacity (Resistive Load)

Power Level (code W): 5A @ 125/250V AC or 5A @ 30V DC
Logic Level (code G): 0.4VA maximum @ 28V AC/DC maximum
 Note: See Supplement Index (page Z1) to find explanation of operating range.

Other Ratings

Contact Resistance: 50 milliohms maximum for silver; 100 milliohms maximum for gold
Insulation Resistance: 200 megohms minimum @ 500V DC
Dielectric Strength: 1,000V AC minimum between contacts;
 1,500V AC minimum between contacts & case
Mechanical Life: 1,000,000 operations minimum for momentary &
 200,000 operations minimum for alternate action
Electrical Life: 10,000 operations minimum for silver;
 200,000 operations minimum for gold
Nominal Operating Force: Single Pole: 194 grams
 Double Pole: 260 grams
Contact Timing: Break before make
Travel: 1.0mm (.039") pretravel; 1.3mm (.051") overtravel; 2.3mm (.091") total travel

Materials & Finishes

Housing/Bezel: Glass fiber reinforced polyamide
Snap-in Frame: Stainless steel
Movable Contactor: Phosphor bronze
Movable Contacts: Silver alloy with silver plating or copper with gold plating over nickel
Stationary Contacts: Silver alloy with silver plating or copper with gold plating over nickel
Switch Terminals: Phosphor bronze with silver or gold plating
Lamp Terminals: Brass with silver plating for bright LED models; brass with tin-lead plating for other models
Base: Glass fiber reinforced liquid crystal polymer

Environmental Data

Operating Temp Range: Illuminated: -25°C through +50°C (-13°F through +122°F) for Bright & Bicolor LEDs
 -20°C through +50°C (-4°F through +122°F) for Super Bright LEDs
 Nonilluminated: -20°C through +70°C (-4°F through +158°F)
Humidity: 90 ~ 95% humidity for 96 hours @ 40°C (104°F)
Vibration: 10 ~ 55Hz with peak-to-peak amplitude of 1.5mm traversing the frequency range
 & returning in 1 minute; 3 right angled directions for 2 hours
Shock: 50g acceleration (tested in 6 right angled directions, with 5 shocks in each direction)

Installation

Cap Installation Force: 1.53 kg (3.37 lb)
Soldering Time & Temperature: 3 seconds @ 350°C or 5 seconds @ 270°C
Process Seal: Not available

Standards & Certifications

Flammability Standards: UL94V-0 rated base
UL Recognized: All single & double pole models recognized at 5A @ 125/250V AC or
 0.014A @ 28V DC; UL File No. E44145

POLES & CIRCUITS

		Plunger Position () = Momentary		Connected Terminals		Throw & Schematics
Pole	Model	Normal	Down	Normal	Down	
SP	UB215 UB216*	ON ON	(ON) ON	1-3	1-2	SPDT
DP	UB225 UB226*	ON ON	(ON) ON	1-3 4-6	1-2 4-5	DPDT

* When in latched position for the alternate circuit, cap positions above the housing are:
 1.5mm (.059") for snap-in models & 7.0mm (.276") for PCB models.

SHAPES & MOUNTING TYPES

PCB Mounting

SK

Square

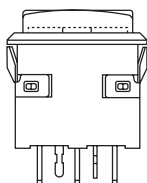

SP, Single Color LED

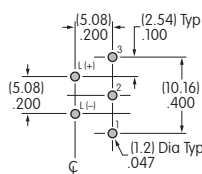

DP, Single Color LED

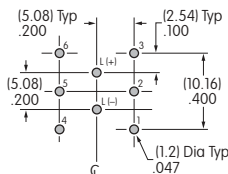

SP, Bicolor LED

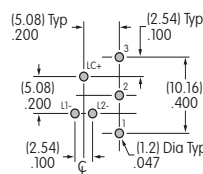

DP, Bicolor LED

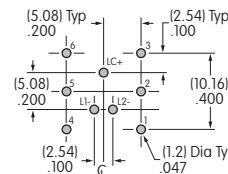

Nonilluminated models have no lamp terminals.

Snap-In Mounting (Solder Lug)

KK

Square with Bezel

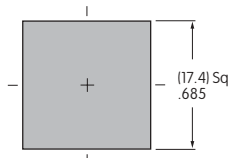
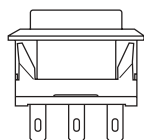

Panel Thickness
1.0 ~ 3.2mm
(.039 ~ .126")

CONTACT MATERIALS & RATINGS

W

Silver Contacts

Power Level

5A @ 125V AC & 250V AC

G

Gold Contacts

Logic Level

0.4VA maximum @ 28V AC/DC maximum

See Supplement Index (page Z1) for complete explanation of operating range.

TERMINALS

01

Solder Lug

.032" x .063" oblong hole accommodates two solid or stranded 24-gauge wires.

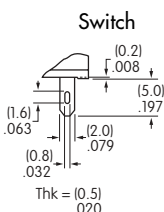

Lamp

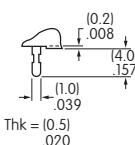

03

Straight PC

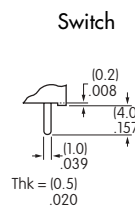

Lamp

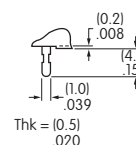

LED COLORS & SPECIFICATIONS

Electrical specifications are determined at a basic temperature of 25°C. LED circuit is independent of switch operation.
 If the source voltage is greater than rated voltage, a ballast resistor is required.
 The ballast resistor calculation and more lamp detail are shown in the Supplement; see Supplement Index (page Z1).

Bright, Super Bright, & Bicolor LEDs

Super Bright LED is Electrostatic Sensitive	Attention Electrostatic Sensitive Devices	Bright			Units	Super Bright			Bicolor	Units
		5C Red	5D Amber	5F Green		6B White	6F Green	6G Blue	CF Red/Green	
Forward Peak Current	I_{FM}	30	30	25	mA	25	25	25	60/60	mA
Continuous Forward Current	I_F	20	20	20	mA	20	20	20	48/48	mA
Forward Voltage	V_F	1.85	2.0	2.25	V	3.6	3.5	3.6	1.8/2.0	V
Reverse Peak Voltage	V_{RM}	5	5	5	V	5	5	5	5/5	V
Current Reduction Rate Above 25°C	ΔI_F	0.40	0.42	0.46	mA/°C	0.40	0.40	0.40	1.0/1.0	mA/°C

Bright Single Color LED with 1 element



Super Bright Single Color LED with 1 element



Bicolor LED with 6 elements
 Super Bright and Bicolor LEDs combine only with cap color codes 1JB, 2B, and 3JB.

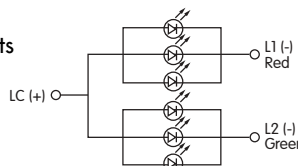

Orange color can be achieved by lighting red and green simultaneously on the bicolor LED.

N **Nonilluminated** Code N indicates that no lamp is used.

CAP TYPES & COLOR COMBINATIONS FOR ILLUMINATED

1 **AT3074 Sculptured**

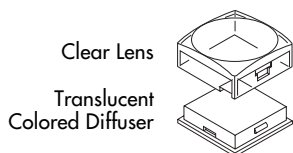
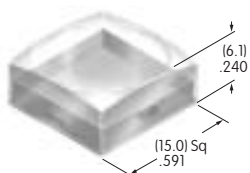

Lens/Diffuser Colors Available:

- JB** Clear/White
- JD** Clear/Amber
- JC** Clear/Red
- JF** Clear/Green

Material: Polycarbonate
 Finish: Glossy

2 **AT3075 Beveled**

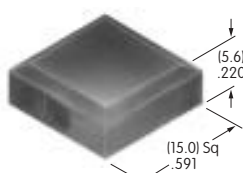

Cap Colors Available:

- B** White
- D** Amber
- C** Red
- F** Green

Material: Polycarbonate
 Finish: Glossy

3 **AT3076 Flat**

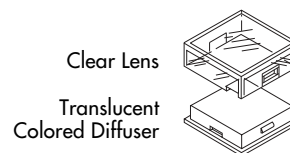
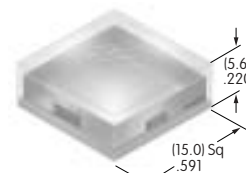

Lens/Diffuser Colors Available:

- JB** Clear/White
- JD** Clear/Amber
- JC** Clear/Red
- JF** Clear/Green

Material: Polycarbonate
 Finish: Glossy

CAP TYPES & COLOR COMBINATIONS FOR NONILLUMINATED

4 AT3073 Sculptured

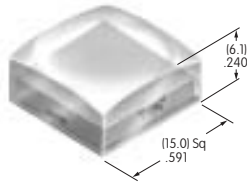

Lens/Insert
Colors Available:

JA Clear/Black

JB Clear/White

JC Clear/Red

JE Clear/Yellow

JF Clear/Green

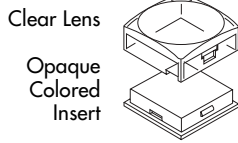

Material: Polycarbonate

Finish: Glossy

5 AT3077 Beveled

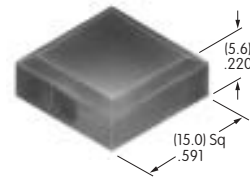

Cap
Colors Available:

A Black

B White

C Red

E Yellow

F Green

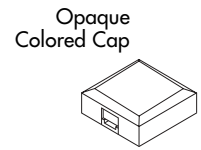

Material: Polycarbonate

Finish: Glossy

TYPICAL SWITCH DIMENSIONS

Single Pole • PCB Mount

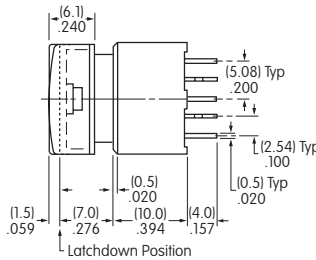
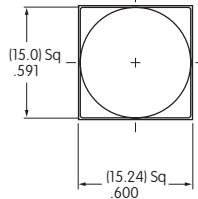

Single Color LED

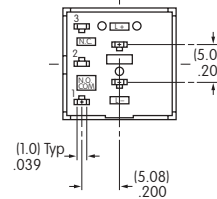

Bicolor LED

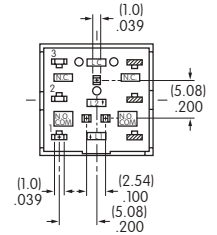

UB215SKG035C-1JC

Single Color LED Side View

Double Pole • Snap-in Mount • Solder Lug

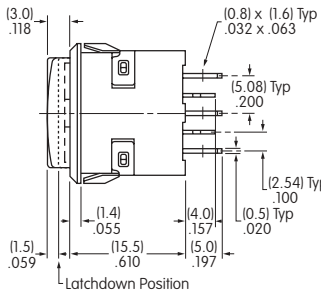
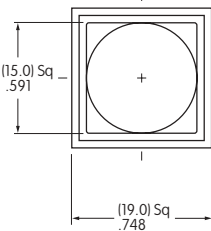

Single Color LED

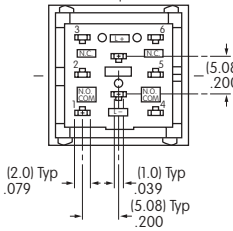

Bicolor LED

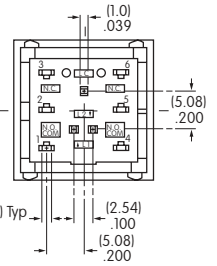

UB226KKW016F-1JF

Single Color LED Side View

Double Pole • PCB Mount

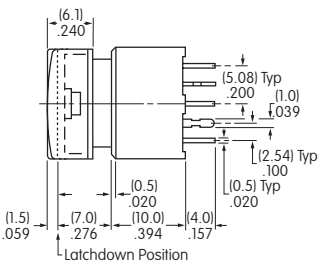
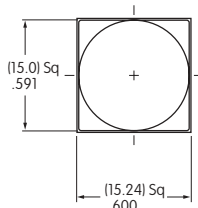

Single Color LED

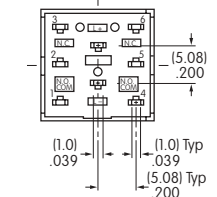

Bicolor LED

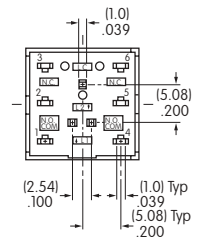

UB225SKG03CF-1JB

Bicolor LED Side View

TYPICAL SWITCH DIMENSIONS

**Single Pole
Snap-in Mount
Solder Lug**

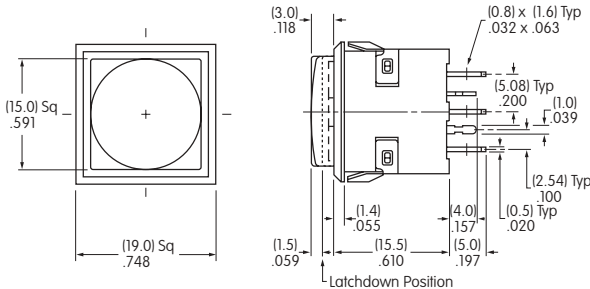

Single Color LED

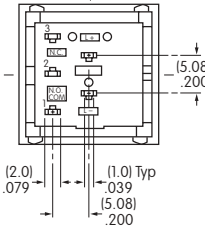

Bicolor LED

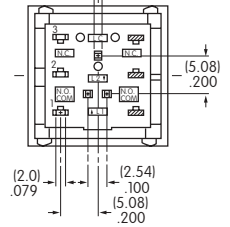

UB216KKW01CF-1JB

Bicolor LED Side View

OPTIONAL ACCESSORIES

Splash Cover

AT4145 Square

Not for use with barrier type models.

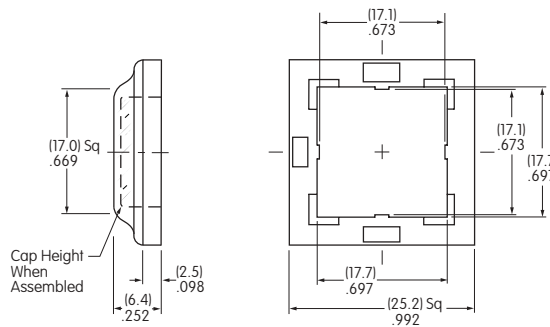
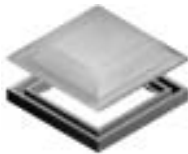

Materials
 Lid: Clear PVC
 Operating temperature range:
 0°C ~ +70°C
 (32°F ~ 158°C).
 Gasket: Polyethylene

Panel Thickness
 1.0mm ~ 2.5mm
 (.039" ~ .098")

Protective Guards for Snap-in Mount

AT4141 Opens 90°

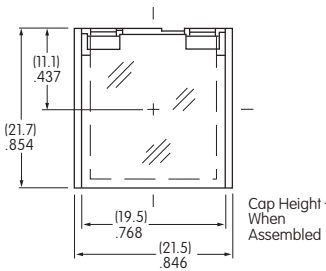

AT4142 Opens 180° (spring loaded for automatic closing)

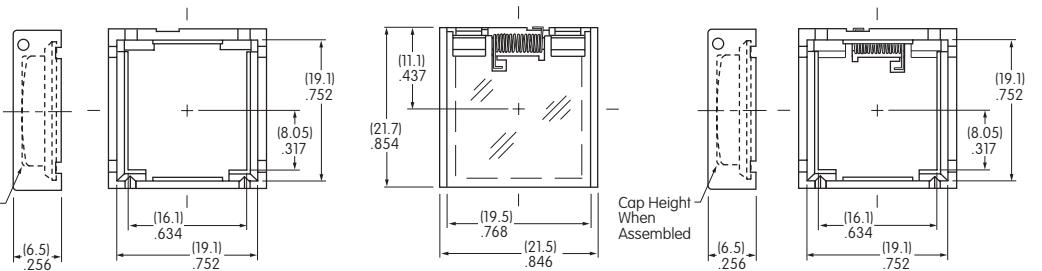

Materials: Clear Polycarbonate Cover & Black GFR Polyamide Base; Recommended Panel Thickness: 1.0 ~ 2.7mm (.039" ~ .106")

Barriers for Snap-in Mount

AT4143 End AT4144 Center

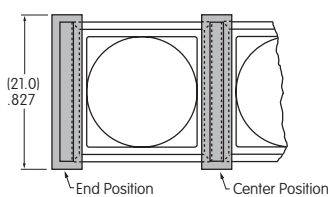

Material: Polyamide

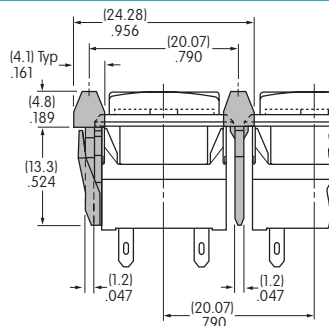

Cutouts for More Than 1 Switch
 $A = .786" \times \text{Number of Switches} + .051"$

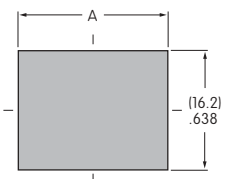

LEGENDS

General information and basic specifications are presented here for customers who want to do their own legends.

Suggested Printable Area for UB Lens & Film Insert

Square Cap



Rectangular Cap

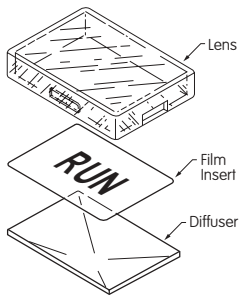

Shaded areas are printable areas.

Lens

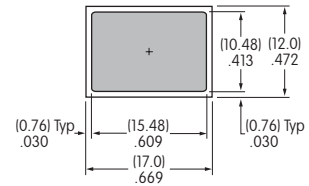
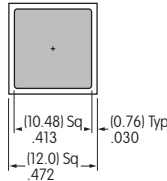

Film Insert

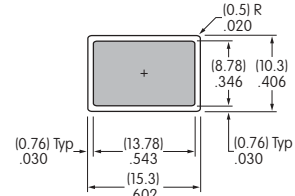
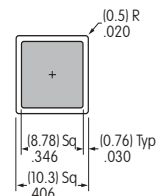

Recommended Print Methods:

Screen Print on Lens or Film Insert; Pad Print on Lens. Epoxy based ink is recommended.

Film Insert: Clear Polyester
4 mil max. thickness

Suggested Printable Area for UB2 Lens & Film Insert

Shaded areas are printable areas.

Beveled Cap

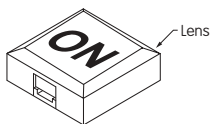

Flat Cap

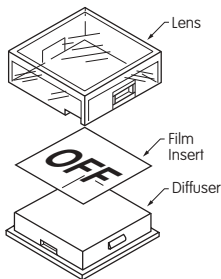

Lens

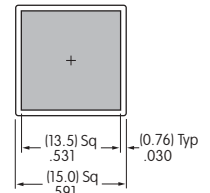
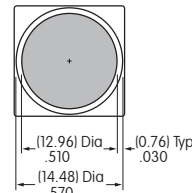

Film Insert

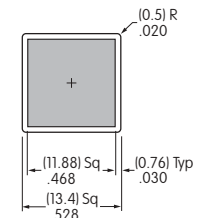
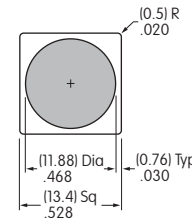

Recommended Print Methods:

Screen Print on Lens or Film Insert; Pad Print on Lens. Epoxy based ink is recommended.

Film Insert: Clear Polyester
4 mil max. thickness

LEGEND PACKET FOR ORDERING CAPS WITH LEGENDS



1. To order caps with legends contact the factory and request the UB/UB2 Legend Packet.
2. Once you determine your desired legend, fill out the ordering work sheet included in the packet.
3. Return the completed work sheet to receive a quotation.