

Excellent Integrated System Limited

Stocking Distributor

Click to view price, real time Inventory, Delivery & Lifecycle Information:

[Fairchild Semiconductor](#)
[QRE00034](#)

For any questions, you can email us directly:

sales@integrated-circuit.com

PACKAGE DIMENSIONS

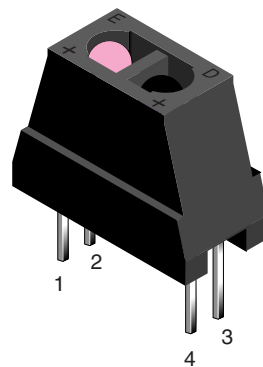
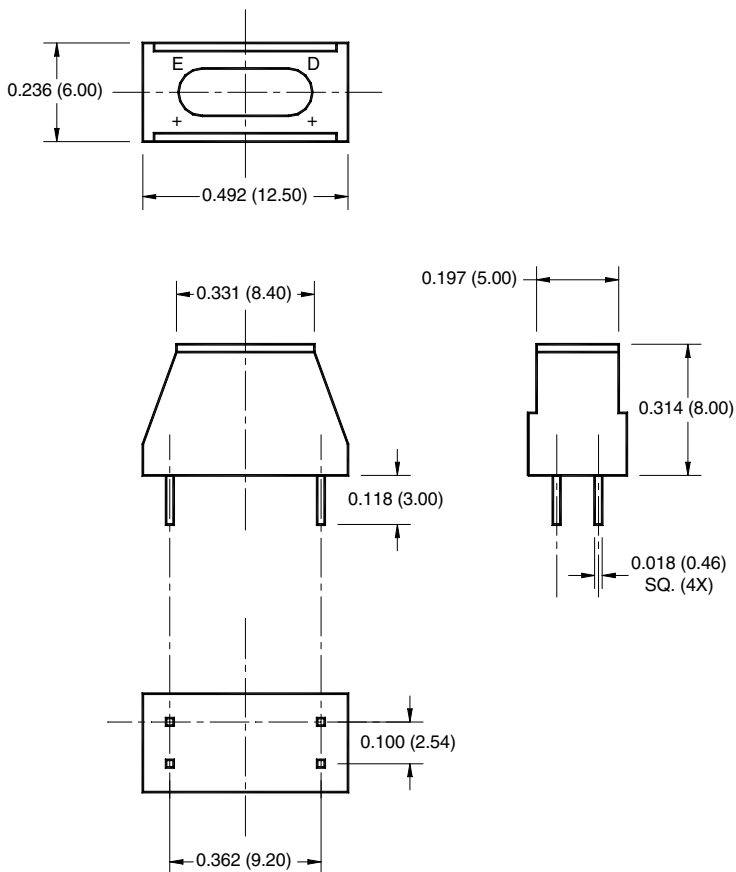

SCHEMATIC

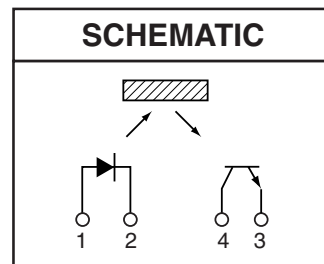

NOTES:

1. Dimensions for all drawings are in inches.
2. Tolerance of $\pm .010$ on all non-nominal dimensions unless otherwise specified.

DESCRIPTION

The QRE00034 reflective object sensor consists of an infrared emitting diode and an NPN phototransistor mounted side by side on a converging optical axis in a black housing. The phototransistor responds to radiation from the emitting diode only when a reflective object passes in its field of view.

FEATURES

- Phototransistor output
- No contact surface sensing
- Daylight filter on the sensor
- Emitter $\lambda = 940$ nm

ABSOLUTE MAXIMUM RATINGS ($T_A = 25^\circ\text{C}$ unless otherwise specified)

Parameter	Symbol	Rating	Units
Operating Temperature	T_{OPR}	-40 to +85	$^\circ\text{C}$
Storage Temperature	T_{STG}	-40 to +85	$^\circ\text{C}$
Soldering Temperature (Iron) ^(2,3,4)	T_{SOL-I}	240 for 5 sec	$^\circ\text{C}$
Soldering Temperature (Flow) ^(2,3)	T_{SOL-F}	260 for 10 sec	$^\circ\text{C}$
EMITTER			
Continuous Forward Current	I_F	50	mA
Reverse Voltage	V_R	5	V
Peak Forward Current	I_{FP}	1	A
Power Dissipation ⁽¹⁾	P_D	100	mW
SENSOR			
Collector-Emitter Voltage	V_{CEO}	30	V
Power Dissipation ⁽¹⁾	P_D	100	mW

ELECTRICAL / OPTICAL CHARACTERISTICS ($T_A = 25^\circ\text{C}$)

PARAMETER	TEST CONDITIONS	SYMBOL	MIN	TYP	MAX	UNITS
EMITTER						
Forward Voltage	$I_F = 20\text{ mA}$	V_F	—	—	1.7	V
Reverse Current	$V_R = 5\text{ V}$	I_R	—	—	100	μA
Peak Emission Wavelength	$I_F = 20\text{ mA}$	λ_{PE}	—	940	—	nm
SENSOR						
Dark Current	$V_{CE} = 10\text{ V}, I_F = 0\text{ mA}$	I_D	—	—	100	nA
Peak Sensitivity Wavelength	$V_{CE} = 5\text{ V}$	λ_{PS}	—	880	—	nm
COUPLED						
Collector Current	$I_F = 20\text{ mA}, V_{CE} = 10\text{ V}^{(6,7)}$	$I_{C(ON)}$	0.16	—	2.00	mA
Collector Emitter Saturation Voltage	$I_F = 20\text{ mA}, I_C = 0.5\text{ mA}$	$V_{CE(SAT)}$	—	—	0.4	V
Rise Time	$V_{CE} = 5\text{ V}, R_L = 100\ \Omega$	t_r	—	10	—	μs
Fall Time	$I_{C(ON)} = 5\text{ mA}$	t_f	—	50	—	μs

NOTES

- Derate power dissipation linearly 1.33 mW/ $^\circ\text{C}$ above 25°C .
- RMA flux is recommended.
- Methanol or isopropyl alcohols are recommended as cleaning agents.
- Soldering iron tip at 1/16" (1.6mm) from housing.
- Pulse conditions: $t_p = 10\ \mu\text{s}$; $T = 1\text{ ms}$.
- Measured as an Eastman Kodak neutral white test card with 90% diffused reflectance as a reflecting surface.
- 0.160" (4 mm) distance from sensor face to reflector surface.

TYPICAL PERFORMANCE CURVES

Fig. 1 Normalized Collector Current vs. Distance

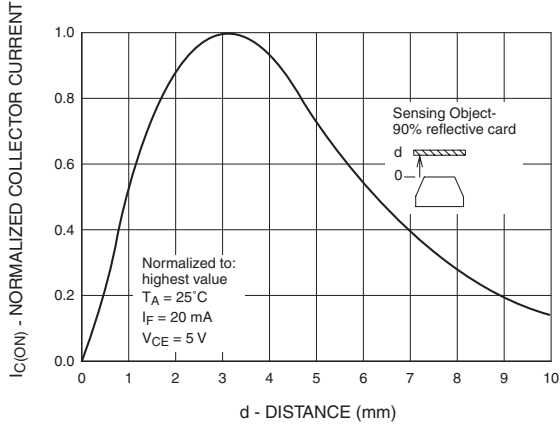

Fig. 2 Forward Current vs. Forward Voltage

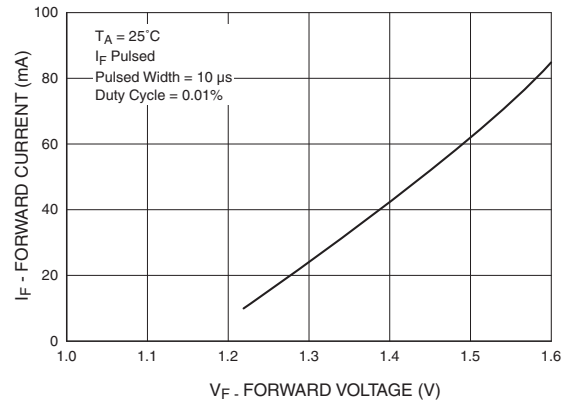

Fig. 3 Normalized Collector Current vs. Angle Deviation

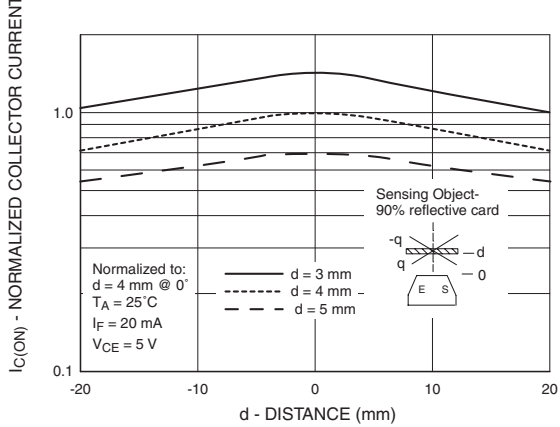

Fig. 4 Collector Current vs. Forward Current

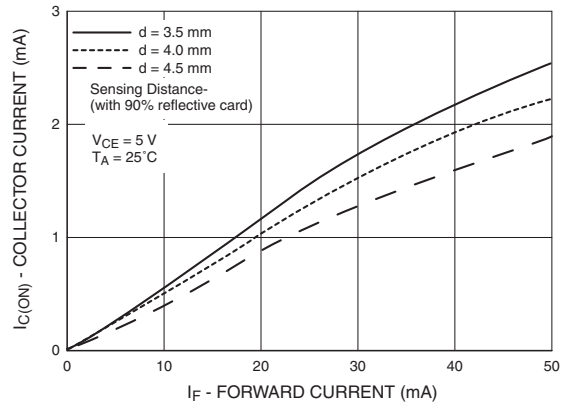

Fig. 5 Normalized Collector Current vs. Ambient Temperature

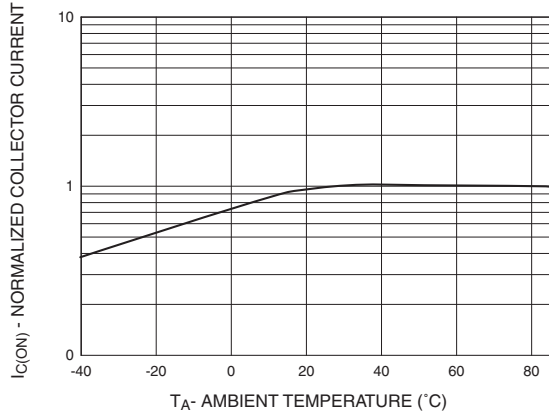

Fig. 6 Rise and Fall Time vs. Collector Current

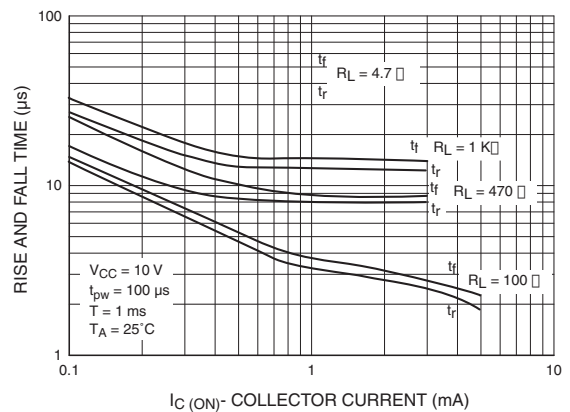

Fig. 7 Collector Current vs. Collector to Emitter Voltage

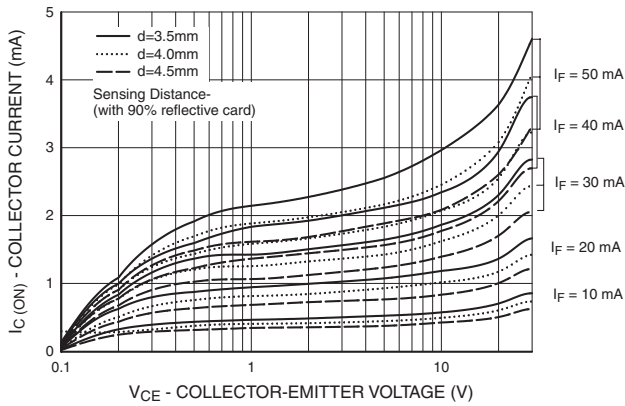

Fig. 8 Collector Emitter Dark Current vs. Forward Current

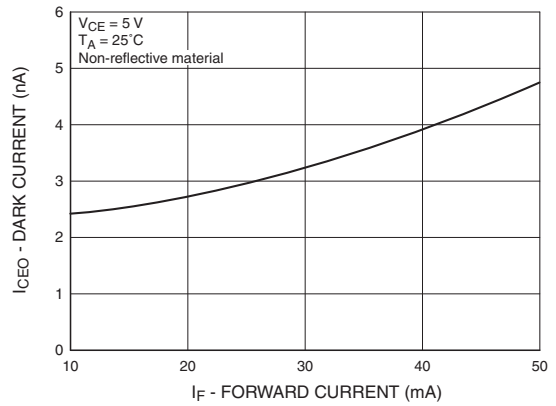

Fig. 9 Forward Voltage vs. Ambient Temperature

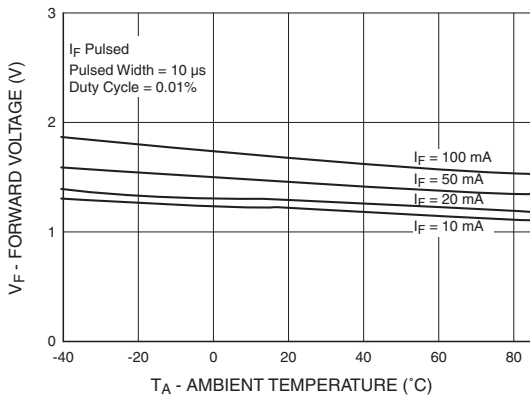

Fig. 10 Normalized Collector Current vs. Distance d_2

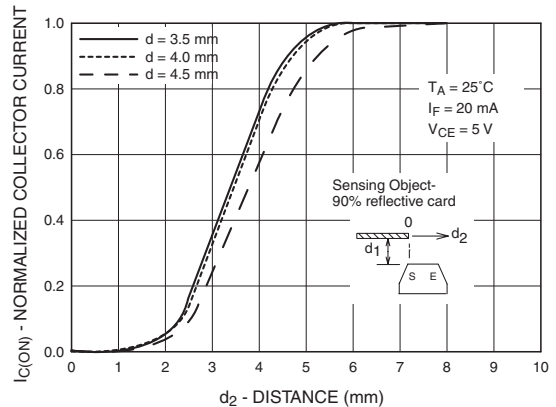

Fig. 11 Normalized Collector Current vs. Distance d_2

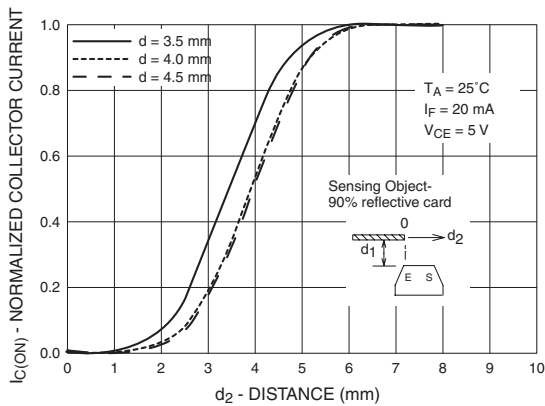
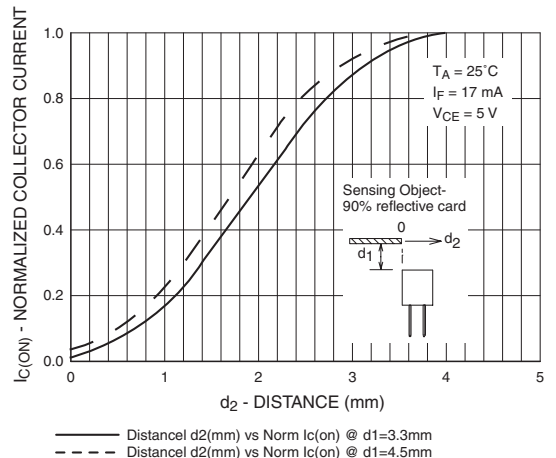
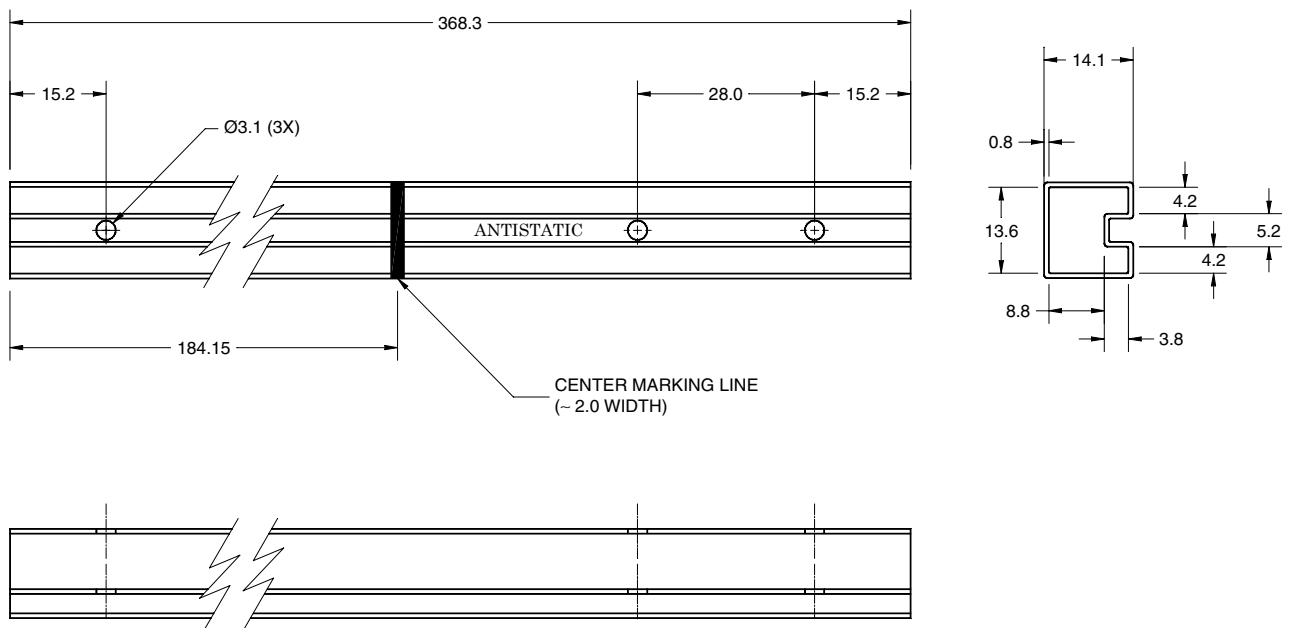

Fig. 12 Normalized Collector Current vs. Distance d_2



ANTISTATIC PLASTIC TUBE PACKING (50 PCS PER TUBE)



NOTES

1. Dimensions: All dimensions are in mm.
2. Color: Clear (Transparent).
3. Antistatic resistivity level: $10^5 - 10^{12}$ Ohm/sq.
4. Tolerance: ± 0.25 inches, unless otherwise specified.

DISCLAIMER

FAIRCHILD SEMICONDUCTOR RESERVES THE RIGHT TO MAKE CHANGES WITHOUT FURTHER NOTICE TO ANY PRODUCTS HEREIN TO IMPROVE RELIABILITY, FUNCTION OR DESIGN. FAIRCHILD DOES NOT ASSUME ANY LIABILITY ARISING OUT OF THE APPLICATION OR USE OF ANY PRODUCT OR CIRCUIT DESCRIBED HEREIN; NEITHER DOES IT CONVEY ANY LICENSE UNDER ITS PATENT RIGHTS, NOR THE RIGHTS OF OTHERS.

LIFE SUPPORT POLICY

FAIRCHILD'S PRODUCTS ARE NOT AUTHORIZED FOR USE AS CRITICAL COMPONENTS IN LIFE SUPPORT DEVICES OR SYSTEMS WITHOUT THE EXPRESS WRITTEN APPROVAL OF THE PRESIDENT OF FAIRCHILD SEMICONDUCTOR CORPORATION. As used herein:

1. Life support devices or systems are devices or systems which, (a) are intended for surgical implant into the body, or (b) support or sustain life, and (c) whose failure to perform when properly used in accordance with instructions for use provided in labeling, can be reasonably expected to result in a significant injury of the user.
2. A critical component in any component of a life support device or system whose failure to perform can be reasonably expected to cause the failure of the life support device or system, or to affect its safety or effectiveness.