

## Excellent Integrated System Limited

Stocking Distributor

Click to view price, real time Inventory, Delivery & Lifecycle Information:

[Fairchild Semiconductor](#)

[FFL60U60DNTU](#)

For any questions, you can email us directly:

[sales@integrated-circuit.com](mailto:sales@integrated-circuit.com)



## FFL60U60DN

### Features

- High voltage and high reliability
- High speed switching
- Low forward voltage

### Applications

- General purpose
- Switching mode power supply
- Free-wheeling diode for motor application
- Power switching circuits

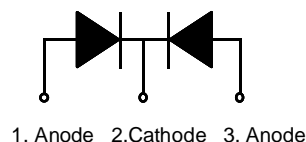
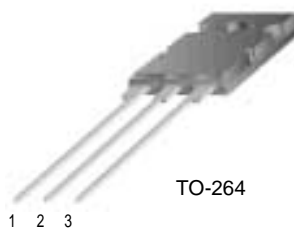

## ULTRA FAST RECOVERY POWER RECTIFIER

### Absolute Maximum Ratings (per diode) $T_C=25^\circ\text{C}$ unless otherwise noted

Symbol	Parameter	Value	Units
$V_{RRM}$	Peak Repetitive Reverse Voltage	600	V
$I_{F(AV)}$	Average Rectified Forward Current @ $T_C = 100^\circ\text{C}$	60	A
$I_{FSM}$	Non-repetitive Peak Surge Current 60Hz Single Half-Sine Wave	360	A
$T_J, T_{STG}$	Operating Junction and Storage Temperature	- 65 to +150	$^\circ\text{C}$

### Thermal Characteristics

Symbol	Parameter	Value	Units
$R_{\theta JC}$	Maximum Thermal Resistance, Junction to Case	0.45	$^\circ\text{C/W}$

### Electrical Characteristics (per diode) $T_C=25^\circ\text{C}$ unless otherwise noted

Symbol	Parameter	Min.	Typ.	Max.	Units	
$V_{FM}^*$	Maximum Instantaneous Forward Voltage $I_F = 60\text{A}$	$T_C = 25^\circ\text{C}$	-	-	2.2	V
		$T_C = 100^\circ\text{C}$	-	-	2.0	
$I_{RM}^*$	Maximum Instantaneous Reverse Current @ rated $V_R$	$T_C = 25^\circ\text{C}$	-	-	25	$\mu\text{A}$
		$T_C = 100^\circ\text{C}$	-	-	250	
$t_{rr}$	Maximum Reverse Recovery Time	-	-	90	ns	
$I_{rr}$	Maximum Reverse Recovery Current	-	-	9	A	
$Q_{rr}$	Maximum Reverse Recovery Charge ( $I_F = 60\text{A}$ , $di/dt = 200\text{A}/\mu\text{s}$ )	-	-	405	nC	
$W_{AVL}$	Avalanche Energy	1.0	-	-	mJ	

\* Pulse Test: Pulse Width=300 $\mu\text{s}$ , Duty Cycle=2%

**Typical Characteristics**

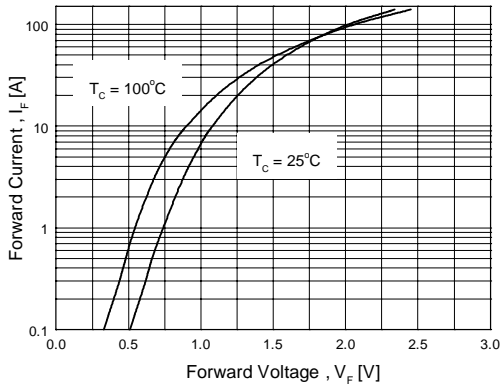

**Figure 1. Typical Forward Voltage Drop vs. Forward Current**

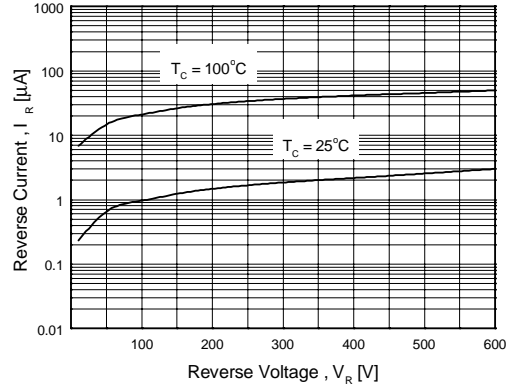

**Figure 2. Typical Reverse Current vs. Reverse Voltage**

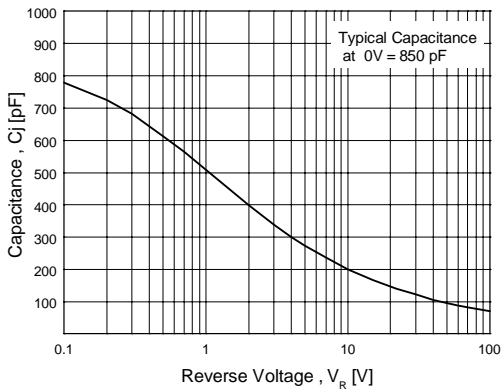

**Figure 3. Typical Junction Capacitance**

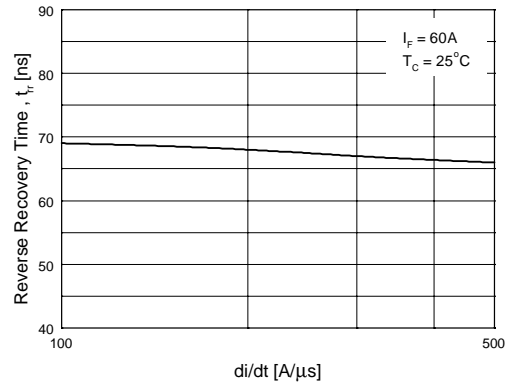

**Figure 4. Typical Reverse Recovery Time vs. di/dt**

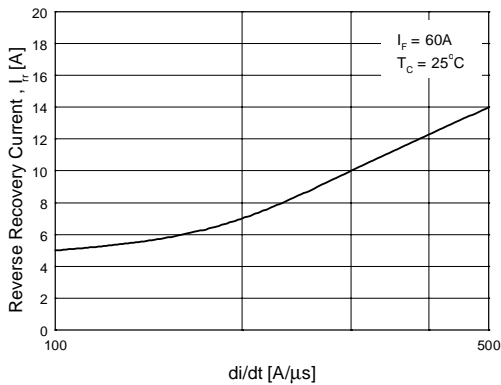

**Figure 5. Typical Reverse Recovery Current vs. di/dt**

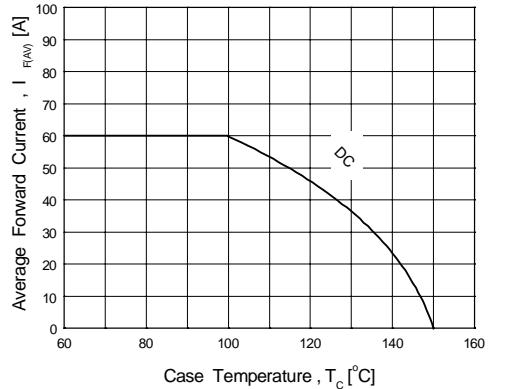

**Figure 6. Forward Current Derating Curve**

**Package Dimensions**

**TO-264**

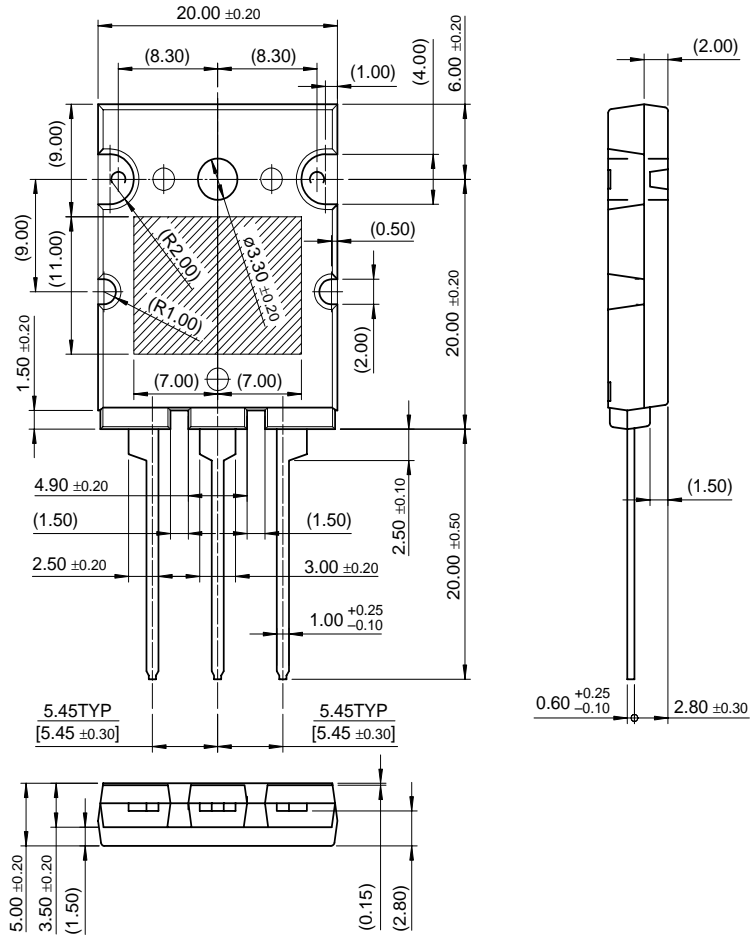

Dimensions in Millimeters

**TRADEMARKS**

The following are registered and unregistered trademarks Fairchild Semiconductor owns or is authorized to use and is not intended to be an exhaustive list of all such trademarks.

ACE <sup>x</sup> ™	FAST <sup>r</sup> ™	QFET™	VCX™
Bottomless™	GlobalOptoisolator™	QS™	
CoolFET™	GTO™	QT Optoelectronics™	
CROSSVOLT™	HiSeC™	Quiet Series™	
DOME™	ISOPLANAR™	SuperSOT™-3	
E <sup>2</sup> CMOS™	MICROWIRE™	SuperSOT™-6	
EnSigna™	OPTOLOGIC™	SuperSOT™-8	
FACT™	OPTOPLANAR™	SyncFET™	
FACT Quiet Series™	POP™	TinyLogic™	
FAST®	PowerTrench®	UHC™	

**DISCLAIMER**

FAIRCHILD SEMICONDUCTOR RESERVES THE RIGHT TO MAKE CHANGES WITHOUT FURTHER NOTICE TO ANY PRODUCTS HEREIN TO IMPROVE RELIABILITY, FUNCTION OR DESIGN. FAIRCHILD DOES NOT ASSUME ANY LIABILITY ARISING OUT OF THE APPLICATION OR USE OF ANY PRODUCT OR CIRCUIT DESCRIBED HEREIN; NEITHER DOES IT CONVEY ANY LICENSE UNDER ITS PATENT RIGHTS, NOR THE RIGHTS OF OTHERS.

**LIFE SUPPORT POLICY**

FAIRCHILD'S PRODUCTS ARE NOT AUTHORIZED FOR USE AS CRITICAL COMPONENTS IN LIFE SUPPORT DEVICES OR SYSTEMS WITHOUT THE EXPRESS WRITTEN APPROVAL OF FAIRCHILD SEMICONDUCTOR CORPORATION. As used herein:

- |   |   |
|---|---|
| <p>1. Life support devices or systems are devices or systems which, (a) are intended for surgical implant into the body, or (b) support or sustain life, or (c) whose failure to perform when properly used in accordance with instructions for use provided in the labeling, can be reasonably expected to result in significant injury to the user.</p> | <p>2. A critical component is any component of a life support device or system whose failure to perform can be reasonably expected to cause the failure of the life support device or system, or to affect its safety or effectiveness.</p> |
|---|---|

**PRODUCT STATUS DEFINITIONS**

**Definition of Terms**

Datasheet Identification	Product Status	Definition
Advance Information	Formative or In Design	This datasheet contains the design specifications for product development. Specifications may change in any manner without notice.
Preliminary	First Production	This datasheet contains preliminary data, and supplementary data will be published at a later date. Fairchild Semiconductor reserves the right to make changes at any time without notice in order to improve design.
No Identification Needed	Full Production	This datasheet contains final specifications. Fairchild Semiconductor reserves the right to make changes at any time without notice in order to improve design.
Obsolete	Not In Production	This datasheet contains specifications on a product that has been discontinued by Fairchild semiconductor. The datasheet is printed for reference information only.