

Excellent Integrated System Limited

Stocking Distributor

Click to view price, real time Inventory, Delivery & Lifecycle Information:

[Molex Connector Corporation](#)
[0430310003](#)

For any questions, you can email us directly:
sales@integrated-circuit.com

13 12 11 10 9 8 7 6 5 4 3 2 1

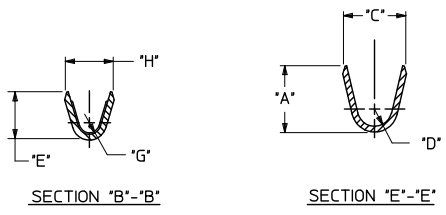

AWG:	MAX. INSULATION
20-24	.073/(1.85)
26-30	.050/(1.27)

ITEM NUMBER	PLATING OPTION	WIRE SIZE	ASSEMBLY OPTION	"A" ±.016 (±0.41)	"C" ±.012 (±0.30)	"D" ±.005 (±0.13)	"E" ±.016 (±0.41)	"G" ±.005 (±0.13)	"H" ±.012 (±0.30)
43031-0001	A	20-24	CHAIN	.090/(2.29)	.100/(2.54)	.030/(0.76)	R. .075/(1.91)	.025/(0.64)	R. .082/(2.08)
43031-0002	B	20-24	CHAIN	.090/(2.29)	.100/(2.54)	.030/(0.76)	R. .075/(1.91)	.025/(0.64)	R. .082/(2.08)
43031-0003	C	20-24	CHAIN	.090/(2.29)	.100/(2.54)	.030/(0.76)	R. .075/(1.91)	.025/(0.64)	R. .082/(2.08)
43031-0004	A	26-30	CHAIN	.075/(1.91)	.083/(2.10)	.025/(0.64)	R. .058/(1.47)	.020/(0.51)	R. .065/(1.65)
43031-0005	B	26-30	CHAIN	.075/(1.91)	.083/(2.10)	.025/(0.64)	R. .058/(1.47)	.020/(0.51)	R. .065/(1.65)
43031-0006	C	26-30	CHAIN	.075/(1.91)	.083/(2.10)	.025/(0.64)	R. .058/(1.47)	.020/(0.51)	R. .065/(1.65)
43031-0007	A	20-24	LOOSE	.090/(2.29)	.100/(2.54)	.030/(0.76)	R. .075/(1.91)	.025/(0.64)	R. .082/(2.08)
43031-0008	B	20-24	LOOSE	.090/(2.29)	.100/(2.54)	.030/(0.76)	R. .075/(1.91)	.025/(0.64)	R. .082/(2.08)
43031-0009	C	20-24	LOOSE	.090/(2.29)	.100/(2.54)	.030/(0.76)	R. .075/(1.91)	.025/(0.64)	R. .082/(2.08)
43031-0010	A	26-30	LOOSE	.075/(1.91)	.083/(2.10)	.025/(0.64)	R. .058/(1.47)	.020/(0.51)	R. .065/(1.65)
43031-0011	B	26-30	LOOSE	.075/(1.91)	.083/(2.10)	.025/(0.64)	R. .058/(1.47)	.020/(0.51)	R. .065/(1.65)
43031-0012	C	26-30	LOOSE	.075/(1.91)	.083/(2.10)	.025/(0.64)	R. .058/(1.47)	.020/(0.51)	R. .065/(1.65)

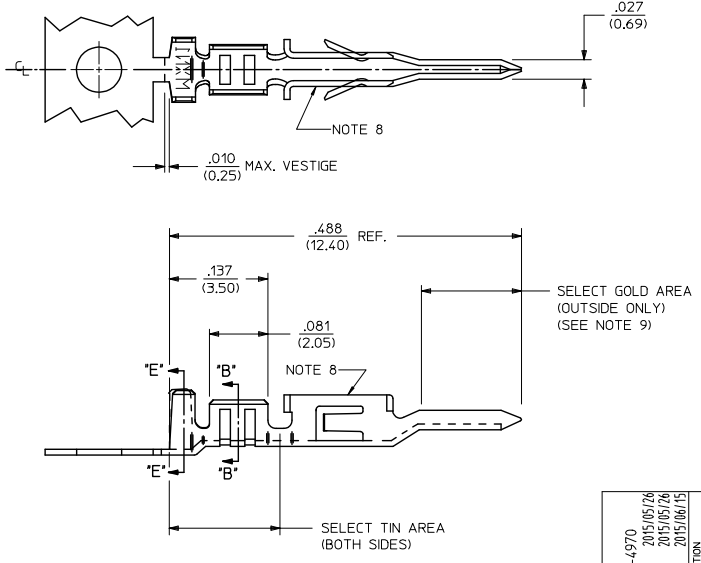

- NOTES:
- MATERIAL: PHOSPHOR BRONZE ALLOY
 - TERMINAL PLATING:
 "A" = HOT TIN DIP: .000040/(0.00102) MIN.
 "B" = .00015/(0.00038) MIN. SELECT GOLD
 .000100/(0.00254) MIN. SELECT TIN
 OVER .000050/(0.00127) MIN. NICKEL
 "C" = .000030/(0.00076) MIN. SELECT GOLD
 .000100/(0.00254) MIN. SELECT TIN
 OVER .000050/(0.00127) MIN. NICKEL
 * MATERIAL NUMBERS WITH SELECT PLATING ARE
 POST-PLATED AFTER FORMING
 - PRODUCT SPECIFICATION: PS-43045, PS-43650, PS-44300-001.
 - PACKAGING SPECIFICATION: PK-43031-001 (REEL),
 AND PK-43030-003 (LOOSE).
 - TERMINAL FOR USE IN MICRO FIT PLUG 43020-****, 43640-****,
 AND 44300-****.
 - FOR TERMINAL ORIENTATION IN PLUG SEE DRAWING SDA-43020-****
 OR SD-43640-****.
 - THIS TERMINAL IS DESIGNED IN METRIC.
 - TERMINAL MAY HAVE AN INWARD OR OUTWARD FORMED SHAPE
 IN THIS AREA.
 - SOME GOLD MAY BE PRESENT ON INSIDE SURFACE.

NOTE 8 DEC NO: UCP2015-4970 DRAWN: JPOX 2015/05/28 CHKD: SMOSEK 2015/05/28 APPROV: SMITH 2015/06/15 J5 REV	QUALITY SYMBOLS	GENERAL TOLERANCES (UNLESS SPECIFIED)	DIMENSION STYLE IN/MM	SCALE ---	DESIGN UNITS METRIC	THIRD ANGLE PROJECTION
	▽=0	4 PLACES ± --- ± ---	DRAWN BY DATE	MICRO-FIT (3.0) MALE TERMINAL molex MATERIAL NO. DOCUMENT NO. SHEET NO. SEE CHART SD-43031-**** 1 OF 1 THIS DRAWING CONTAINS INFORMATION THAT IS PROPRIETARY TO MOLEX INCORPORATED AND SHOULD NOT BE USED WITHOUT WRITTEN PERMISSION		
	▽=0	3 PLACES ± --- ± .014	CHECKED BY DATE			
	▽=0	2 PLACES ± 0.25 ± .010	MUELLER 2002/08/13			
▽=0	1 PLACE ± 0.35 ± ---	APPROVED BY DATE				
		0 PLACE ± ±	MARGULIS 2002/08/13			