

Excellent Integrated System Limited

Stocking Distributor

Click to view price, real time Inventory, Delivery & Lifecycle Information:

[Diodes Incorporated](#)
[ZXTN19055DZTA](#)

For any questions, you can email us directly:

sales@integrated-circuit.com



ZXTN19055DZ

55V, SOT89, NPN medium power transistor

Summary

- $BV_{CEX} > 150V$
- $BV_{CEO} > 55V$
- $I_{C(cont)} = 6A$
- $V_{CE(sat)} < 60mV @ 1A$
- $R_{CE(sat)} = 28m\Omega$
- $P_D = 2.1W$

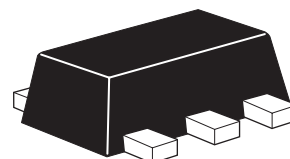

Description

Packaged in the SOT89 outline this low saturation 55V NPN transistor offers extremely low on state losses making it ideal for use in DC-DC circuits and various driving and power management functions.

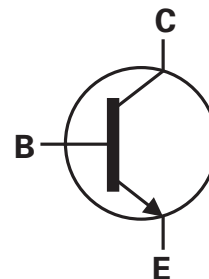

Feature

- Extremely low equivalent on-resistance of 28mΩ
- 6 Amps continuous current
- Up to 10 amps peak current
- Very low saturation voltages
- Excellent h_{FE} characteristics up to 10 amps
- 150V Forward blocking voltage

Applications

- Emergency lighting circuits
- Motor driving (including DC fans)
- Solenoid, relay and actuator drivers
- DC modules
- Backlight inverters

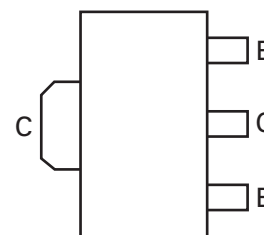

Pinout - top view

Ordering information

Device	Reel size (inches)	Tape width (mm)	Quantity per reel
ZXTN19055DZTA	7	12	1000

Device marking

S75

ZXTN19055DZ

Absolute maximum ratings

Parameter	Symbol	Limit	Unit
Collector-base voltage	V_{CBO}	150	V
Collector-emitter voltage (forward blocking voltage)	V_{CEX}	150	V
Collector-emitter voltage (base open)	V_{CEO}	55	V
Emitter-base voltage	V_{EBO}	7	V
Continuous collector current ^(b)	I_C	6	A
Peak pulse current	I_{CM}	10	A
Power dissipation at $T_{amb} = 25^{\circ}C^{(a)}$	P_D	1.5	W
Linear derating factor		12	mW/°C
Power dissipation at $T_{amb} = 25^{\circ}C^{(b)}$	P_D	2.1	W
Linear derating factor		16.8	mW/°C
Operating and storage temperature range	T_j, T_{stg}	-55 to +150	°C

Thermal resistance

Parameter	Symbol	Limit	Unit
Junction to ambient ^(a)	$R_{\theta JA}$	83	°C/W
Junction to ambient ^(b)	$R_{\theta JA}$	59	°C/W

NOTES:

(a) For a device surface mounted on 25mm x 25mm x 1.6mm FR4 PCB with high coverage of single sided 1oz copper, in still air conditions.

(b) For a device surface mounted on 50mm x 50mm x 1.6mm FR4 PCB with high coverage of single sided 1oz copper, in still air conditions.

ZXTN19055DZ

Characteristics

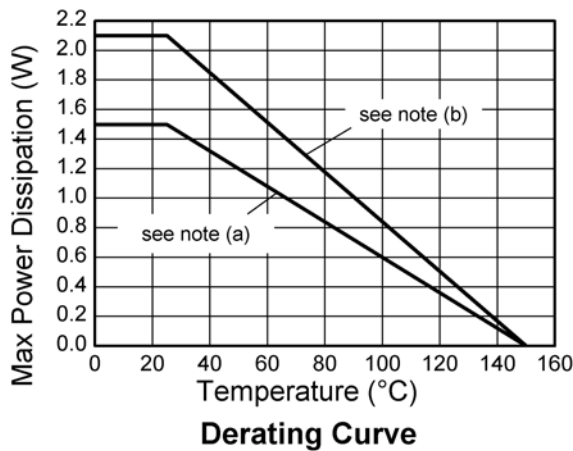
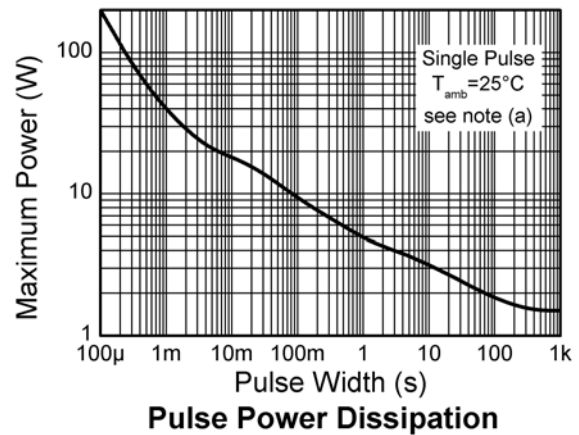
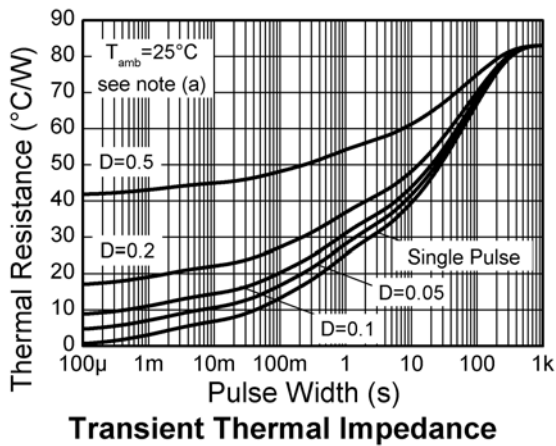
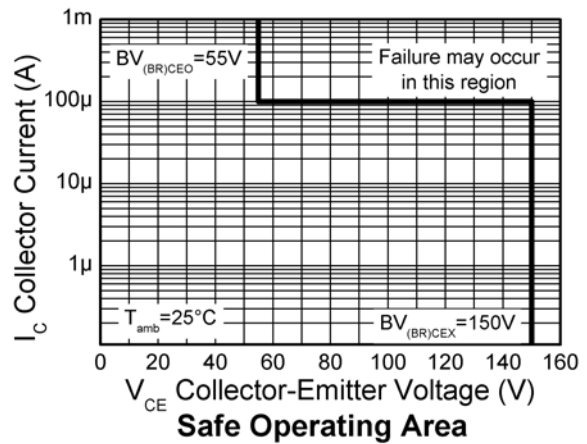
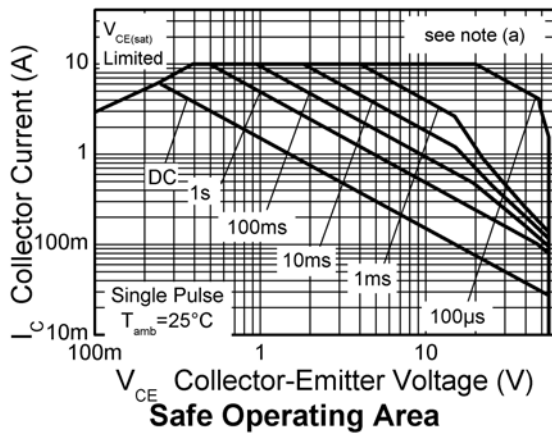

ZXTN19055DZ

Electrical characteristics (at $T_{amb} = 25^{\circ}\text{C}$ unless otherwise stated)

Parameter	Symbol	Min.	Typ.	Max.	Unit	Conditions
Collector-base breakdown voltage	BV_{CBO}	150	200		V	$I_C = 100\text{mA}$
Collector-emitter breakdown voltage (forward blocking)	BV_{CEX}	150	200		V	$I_C = 100\text{mA}$, $R_{BE} < 1\text{k}\Omega$ or $-1\text{V} < V_{BE} < +0.25\text{V}$
Collector-emitter breakdown voltage (base open)	BV_{CEO}	55	75		V	$I_C = 10\text{mA}^{(*)}$
Emitter-base breakdown voltage	BV_{EBO}	7	8.1		V	$I_E = 100\text{mA}$
Collector-base cut-off current	I_{CBO}		<1	50 20	nA μA	$V_{CB} = 120\text{V}$ $V_{CB} = 120\text{V}$, $T_{amb} = 100^{\circ}\text{C}$
Collector-emitter cut-off current	I_{CEX}		<1	100	nA	$V_{CE} = 120\text{V}$; $R_{BE} < 1\text{k}\Omega$ or $-1\text{V} < V_{BE} < 0.25\text{V}$
Emitter cut-off current	I_{EBO}		<1	50	nA	$V_{EB} = 5.6\text{V}$
Collector-emitter saturation voltage	$V_{CE(sat)}$		25 45 40 200 110 140 170	40 70 60 350 140 200 250	mV mV mV mV mV mV mV	$I_C = 0.5\text{A}$, $I_B = 50\text{mA}^{(*)}$ $I_C = 1\text{A}$, $I_B = 50\text{mA}^{(*)}$ $I_C = 1\text{A}$, $I_B = 100\text{mA}^{(*)}$ $I_C = 2\text{A}$, $I_B = 20\text{mA}^{(*)}$ $I_C = 2\text{A}$, $I_B = 40\text{mA}^{(*)}$ $I_C = 4\text{A}$, $I_B = 200\text{mA}^{(*)}$ $I_C = 6\text{A}$, $I_B = 600\text{mA}^{(*)}$
Base-emitter saturation voltage	$V_{BE(sat)}$		800 1000	900 1150	mV mV	$I_C = 2\text{A}$, $I_B = 20\text{mA}^{(*)}$ $I_C = 6\text{A}$, $I_B = 600\text{mA}^{(*)}$
Base-emitter turn-on voltage	$V_{BE(on)}$		760 900	900 1050	mV mV	$I_C = 2\text{A}$, $V_{CE} = 2\text{V}^{(*)}$ $I_C = 6\text{A}$, $V_{CE} = 2\text{V}^{(*)}$
Static forward current transfer ratio	h_{FE}	250 250 180 30	400 400 300 50 20	700		$I_C = 10\text{mA}$, $V_{CE} = 2\text{V}^{(*)}$ $I_C = 1\text{A}$, $V_{CE} = 2\text{V}^{(*)}$ $I_C = 2\text{A}$, $V_{CE} = 2\text{V}^{(*)}$ $I_C = 6\text{A}$, $V_{CE} = 2\text{V}^{(*)}$ $I_C = 10\text{A}$, $V_{CE} = 2\text{V}^{(*)}$
Transition frequency	f_T	140	200		MHz	$I_C = 100\text{mA}$, $V_{CE} = 10\text{V}$ $f = 50\text{MHz}$
Output capacitance	C_{OBO}		21.2	30	pF	$V_{CB} = 10\text{V}$, $f = 1\text{MHz}$
Delay time	t_d		13.8			$V_{CC} = 10\text{V}$,
Rise time	t_r		21.9			$I_C = 1\text{A}$,
Storage time	t_s		546			$I_{B1} = I_{B2} = 100\text{mA}$
Fall time	t_f		106			

NOTES:

(*) Measured under pulsed conditions. Pulse width $\leq 300\mu\text{s}$; duty cycle $\leq 2\%$.

ZXTN19055DZ

Typical characteristics

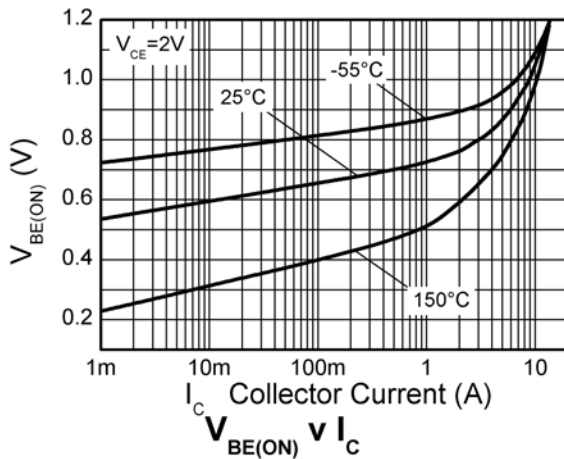
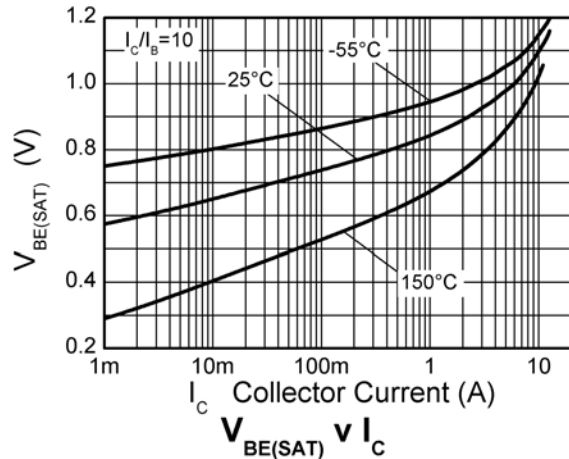
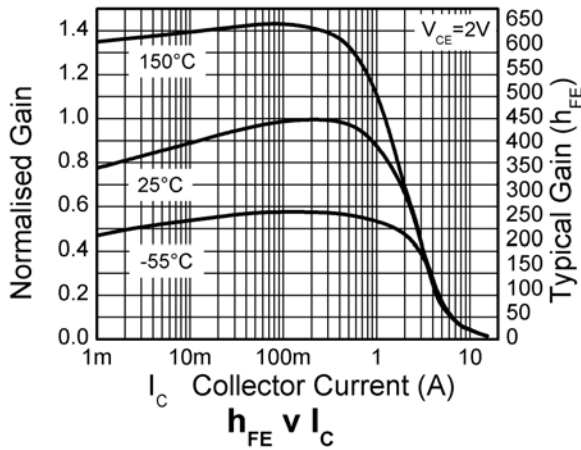
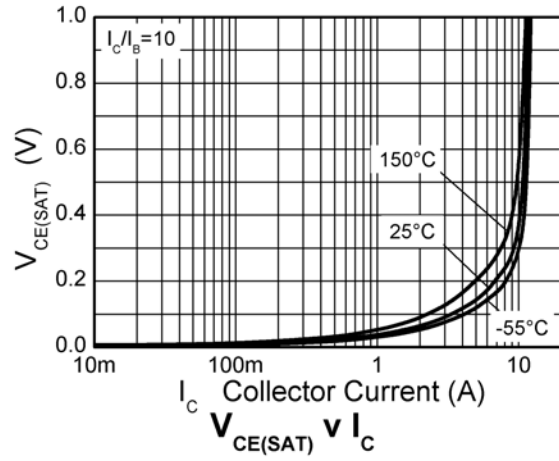
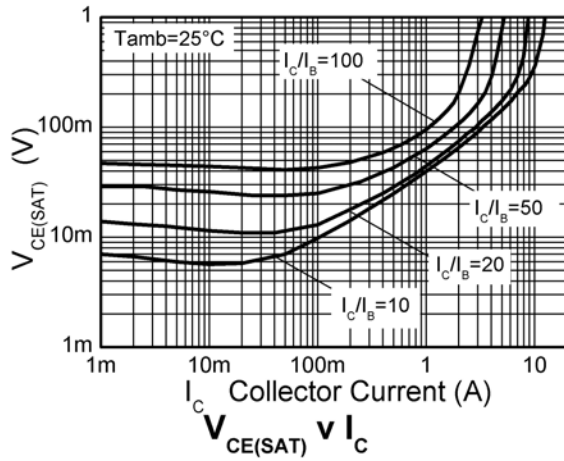

ZXTN19055DZ

Package outline - SOT89

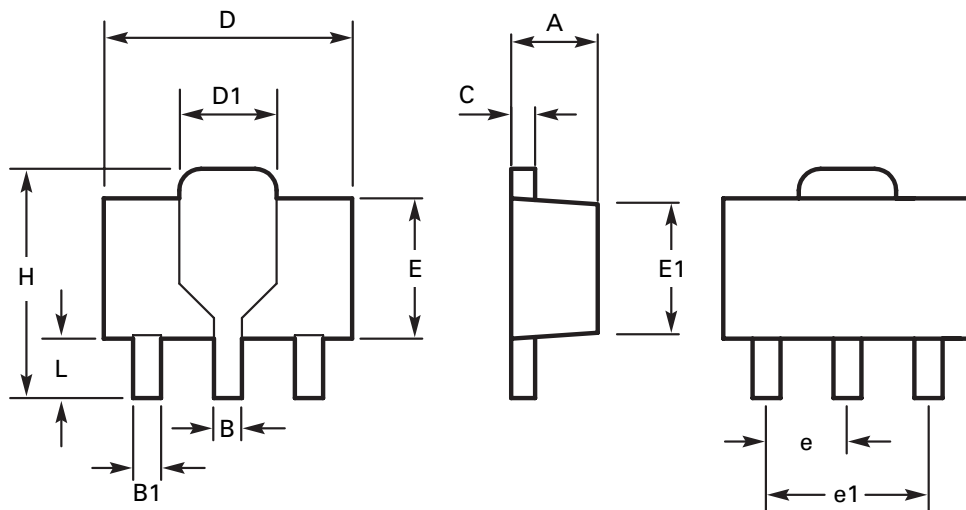

DIM	Millimeters		Inches		DIM	Millimeters		Inches	
	Min	Max	Min	Max		Min	Max	Min	Max
A	1.40	1.60	0.550	0.630	E1	2.13	2.29	0.084	0.090
B	0.44	0.56	0.017	0.022	e	1.50 BSC		0.059 BSC	
B1	0.36	0.48	0.014	0.019	e1	3.00 BSC		0.118 BSC	
C	0.35	0.44	0.014	0.019	H	3.94	4.25	0.155	0.167
D	4.40	4.60	0.173	0.181	L	0.89	1.20	0.155	0.167
E	2.29	2.60	0.090	0.102		-	-	-	-

Note: Controlling dimensions are in millimeters. Approximate dimensions are provided in inches

Europe

Zetex GmbH
Streitfeldstraße 19
D-81673 München
Germany

Telephone: (49) 89 45 49 49 0
Fax: (49) 89 45 49 49 49
europe.sales@zetex.com

Americas

Zetex Inc
700 Veterans Memorial Highway
Hauppauge, NY 11788
USA

Telephone: (1) 631 360 2222
Fax: (1) 631 360 8222
usa.sales@zetex.com

Asia Pacific

Zetex (Asia Ltd)
3701-04 Metroplaza Tower 1
Hing Fong Road, Kwai Fong
Hong Kong

Telephone: (852) 26100 611
Fax: (852) 24250 494
asia.sales@zetex.com

Corporate Headquarters

Zetex Semiconductors plc
Zetex Technology Park, Chadderton
Oldham, OL9 9LL
United Kingdom

Telephone: (44) 161 622 4444
Fax: (44) 161 622 4446
hq@zetex.com

For international sales offices visit www.zetex.com/offices

Zetex products are distributed worldwide. For details, see www.zetex.com/salesnetwork

This publication is issued to provide outline information only which (unless agreed by the company in writing) may not be used, applied or reproduced for any purpose or form part of any order or contact or be regarded as a representation relating to the products or services concerned. The company reserves the right to alter without notice the specification, design, price or conditions of supply of any product or service.