

Excellent Integrated System Limited

Stocking Distributor

Click to view price, real time Inventory, Delivery & Lifecycle Information:

[OSRAM Opto Semiconductors, Inc.](#)
[SFH 4080-Z](#)

For any questions, you can email us directly:
sales@integrated-circuit.com

IR-Lumineszenzdiode
Infrared Emitter
Lead (Pb) Free Product - RoHS Compliant

SFH 4080



**Nicht für Neuentwicklungen im Automobilbereich /
 not for new designs in automotive applications**

Wesentliche Merkmale

- Sehr kleines Gehäuse:
 (LxBxH) 1,7 mm x 0,8 mm x 0,65 mm
- Typische Peakwellenlänge 880 nm
- Gegurtet lieferbar

Features

- Very small package:
 (LxWxH) 1.7 mm x 0.8 mm x 0.65 mm
- Typical Peakwavelength 880 nm
- Available on tape and reel

Anwendungen

- Miniaturlichtschranken für Gleich- und Wechsellichtbetrieb
- Industrieelektronik
- „Messen/Steuern/Regeln“
- Sensorik
- Alarm- und Sicherungssysteme
- IR-Freiraumübertragung

Applications

- Miniature photointerrupters
- Industrial electronics
- For drive and control circuits
- Sensor technology
- Alarm and safety equipment
- IR free air transmission

Typ Type	Bestellnummer Ordering Code	Strahlstärkegruppierung ¹⁾ ($I_F = 100 \text{ mA}$, $t_p = 20 \text{ ms}$) Radiant Intensity Grouping ¹⁾ I_e (mW/sr)
SFH 4080	Q65110A6461	> 1.0 (typ. 2.5)

¹⁾ gemessen bei einem Raumwinkel $\Omega = 0.01 \text{ sr}$ / measured at a solid angle of $\Omega = 0.01 \text{ sr}$

SFH 4080

Grenzwerte ($T_A = 25\text{ °C}$) Maximum Ratings

Bezeichnung Parameter	Symbol Symbol	Wert Value	Einheit Unit
Betriebs- und Lagertemperatur Operating and storage temperature range	$T_{op}; T_{stg}$	- 40 ... + 100	°C
Sperrspannung Reverse voltage	V_R	5	V
Durchlassstrom Forward current	I_F	100	mA
Stoßstrom, $\tau = 10\ \mu\text{s}$, $D = 0$ Surge current	I_{FSM}	2.5	A
Verlustleistung Power dissipation	P_{tot}	180	mW
Wärmewiderstand Sperrschicht - Umgebung bei Montage auf FR4 Platine, Padgröße je 5 mm^2 Thermal resistance junction - ambient mounted on PC-board (FR4), pads size 5 mm^2 each	R_{thJA}	450	K/W
Wärmewiderstand Sperrschicht - Lötstelle bei Montage auf Metall-Block Thermal resistance junction - soldering point, mounted on metal block	R_{thJS}	250	K/W

SFH 4080

Kennwerte ($T_A = 25\text{ °C}$)

Characteristics

Bezeichnung Parameter	Symbol Symbol	Wert Value	Einheit Unit
Wellenlänge der Strahlung Wavelength at peak emission $I_F = 100\text{ mA}$, $t_p = 20\text{ ms}$	λ_{peak}	880	nm
Spektrale Bandbreite bei 50% von I_{max} Spectral bandwidth at 50% of I_{max} $I_F = 100\text{ mA}$	$\Delta\lambda$	80	nm
Abstrahlwinkel Half angle	φ	± 80	Grad deg.
Aktive Chipfläche Active chip area	A	0.09	mm ²
Abmessungen der aktiven Chipfläche Dimensions of the active chip area	$L \times B$ $L \times W$	0.3×0.3	mm ²
Schaltzeiten, I_e von 10% auf 90% und von 90% auf 10%, bei $I_F = 100\text{ mA}$, $R_L = 50\ \Omega$ Switching times, I_e from 10% to 90% and from 90% to 10%, $I_F = 100\text{ mA}$, $R_L = 50\ \Omega$	t_r , t_f	0.5	μs
Kapazität Capacitance $V_R = 0\text{ V}$, $f = 1\text{ MHz}$	C_o	15	pF
Durchlassspannung Forward voltage $I_F = 100\text{ mA}$, $t_p = 20\text{ ms}$ $I_F = 1\text{ A}$, $t_p = 100\ \mu\text{s}$	V_F V_F	1.5 (≤ 1.8) 3.0 (≤ 3.8)	V V
Sperrstrom Reverse current $V_R = 5\text{ V}$	I_R	0.01 (≤ 1)	μA
Gesamtstrahlungsfluss Total radiant flux $I_F = 100\text{ mA}$, $t_p = 20\text{ ms}$	Φ_e	23	mW
Temperaturkoeffizient von I_e bzw. Φ_e , $I_F = 100\text{ mA}$ Temperature coefficient of I_e or Φ_e , $I_F = 100\text{ mA}$	TC_I	- 0.5	%/K
Temperaturkoeffizient von V_F , $I_F = 100\text{ mA}$ Temperature coefficient of V_F , $I_F = 100\text{ mA}$	TC_V	- 2	mV/K
Temperaturkoeffizient von λ , $I_F = 100\text{ mA}$ Temperature coefficient of λ , $I_F = 100\text{ mA}$	TC_λ	+ 0.25	nm/K

SFH 4080

Strahlstärke I_e in Achsrichtung

gemessen bei einem Raumwinkel $\Omega = 0.01$ sr

Radiant Intensity I_e in Axial Direction

at a solid angle of $\Omega = 0.01$ sr

Bezeichnung Parameter	Symbol	Werte Values	Einheit Unit
Strahlstärke Radiant intensity $I_F = 100$ mA, $t_p = 20$ ms	$I_{e \text{ min}}$ $I_{e \text{ typ}}$	1.0 2.5	mW/sr mW/sr
Strahlstärke Radiant intensity $I_F = 1$ A, $t_p = 100$ μ s	$I_{e \text{ typ}}$	22	mW/sr

SFH 4080

Relative Spectral Emission

$I_{rel} = f(\lambda)$

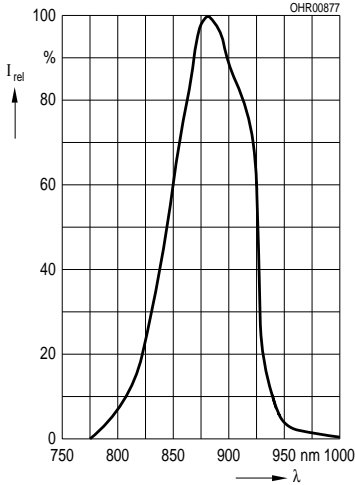

Radiant Intensity $\frac{I_e}{I_e 100 \text{ mA}} = f(I_F)$

Single pulse, $t_p = 20 \mu\text{s}$

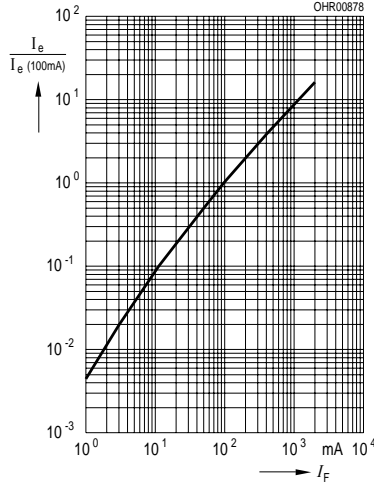

Max. Permissible Forward Current

$I_F = f(T_A), R_{thJA} = 450 \text{ K/W}$

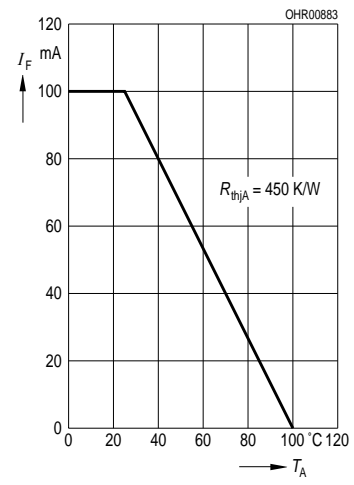

Forward Current

$I_F = f(V_F)$ single pulse, $t_p = 20 \mu\text{s}$

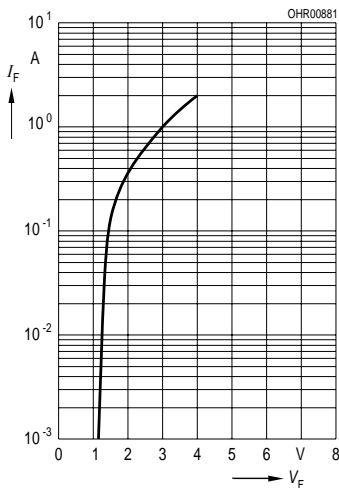

Permissible Pulse Handling Capability

$I_F = f(t_p), T_A = 25^\circ\text{C}$
duty cycle $D =$ parameter

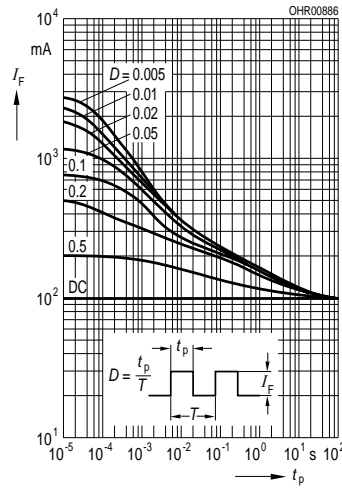

Radiation Characteristics $I_{rel} = f(\varphi)$

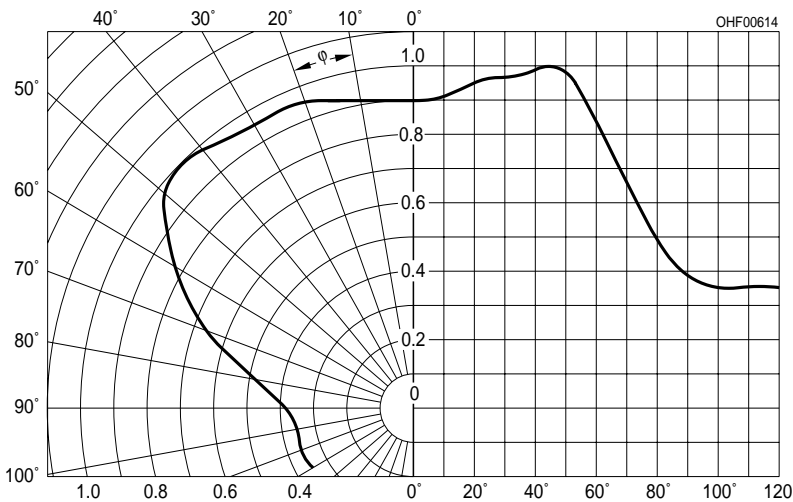

SFH 4080

**Maßzeichnung
 Package Outlines**

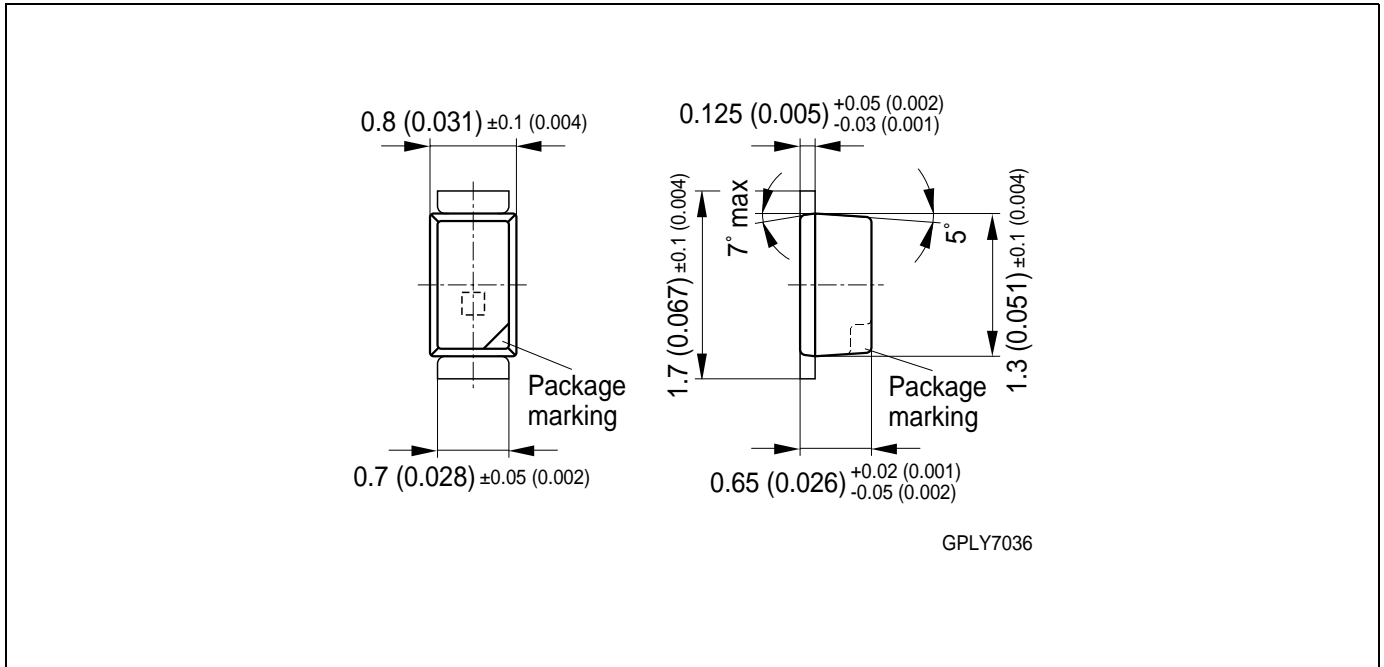

Maße in mm (inch) / Dimensions in mm (inch).

Gehäuse / Package	Epoxydharz, diffus / Epoxy, diffuse
Farbe / Colour	Farblos / colourless
Gehäusemarkierung/ Package marking	Anode

SFH 4080

Empfohlenes Lötpad design
Recommended Solder Pad

Reflow Löten
Reflow Soldering

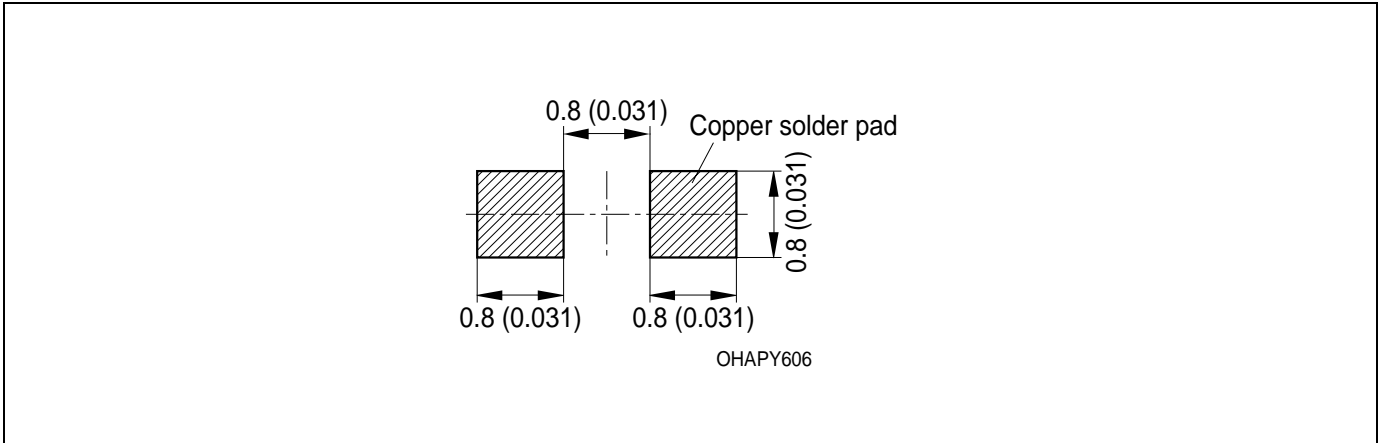

Alternatives Lötpad design
Alternative Solder Pad

Reflow Löten
Reflow Soldering

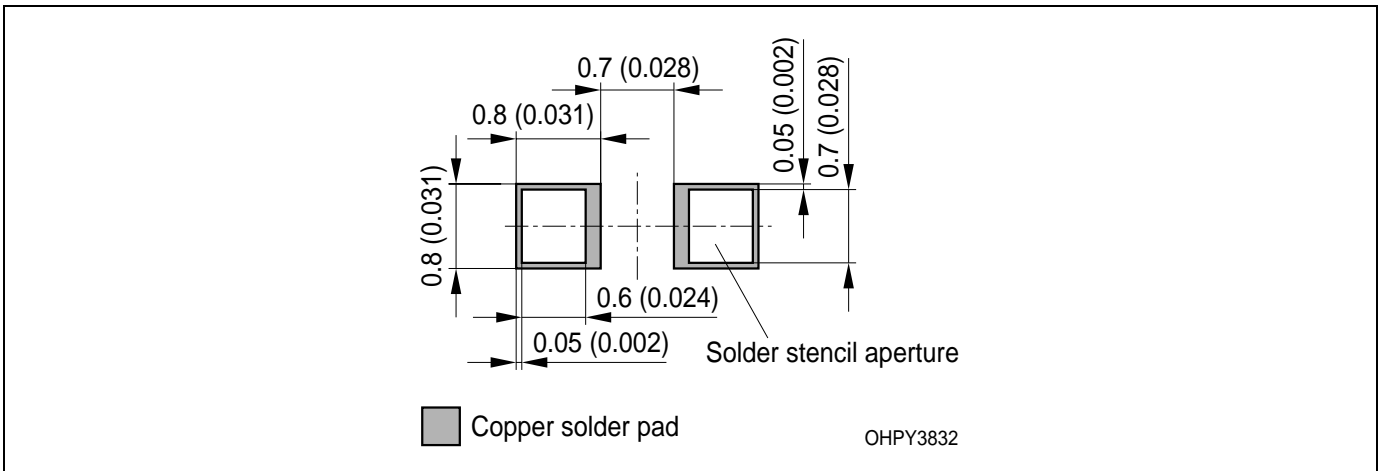

Maße in mm (inch) / Dimensions in mm (inch).

SFH 4080

Lötbedingungen

Soldering Conditions

Reflow Lötprofil für bleifreies Löten

Reflow Soldering Profile for lead free soldering

Vorbehandlung nach JEDEC Level 2

Preconditioning acc. to JEDEC Level 2

(nach J-STD-020C)

(acc. to J-STD-020C)

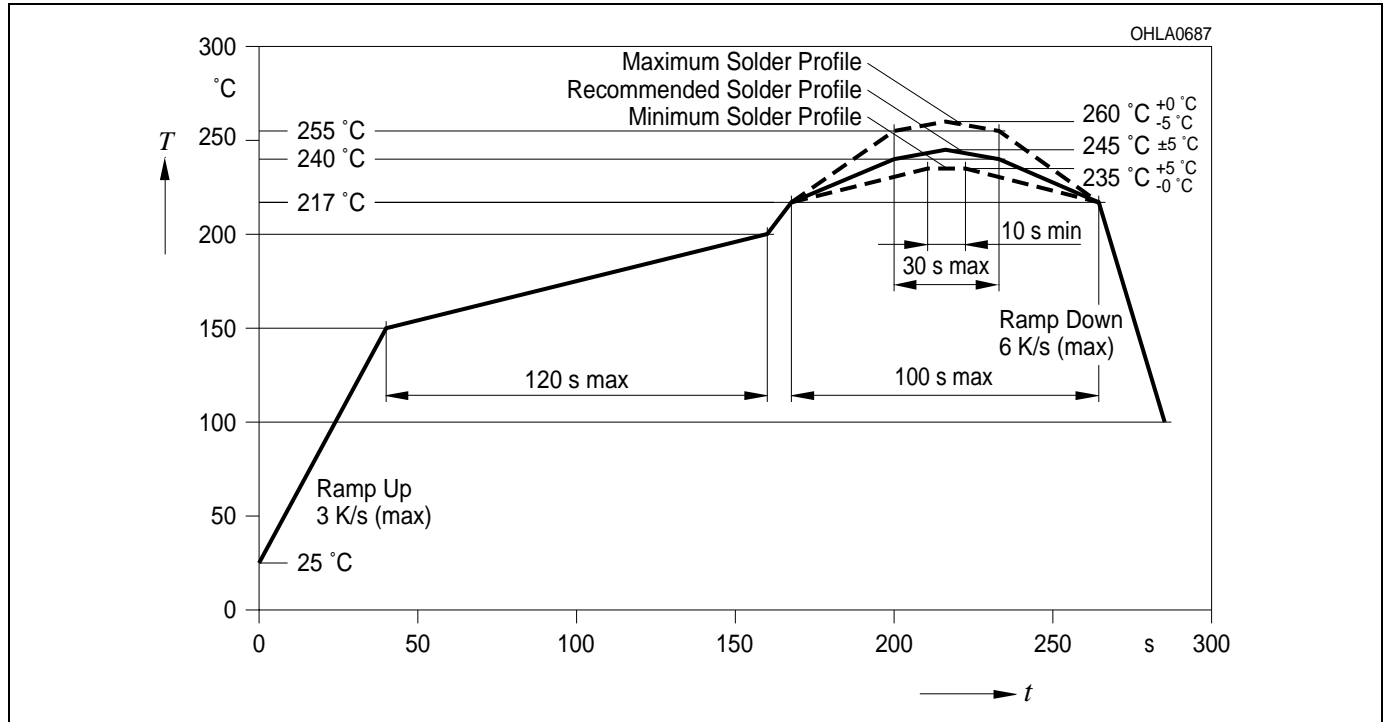

Wellenlöten (TTW)

TTW Soldering

(nach CECC 00802)

(acc. to CECC 00802)

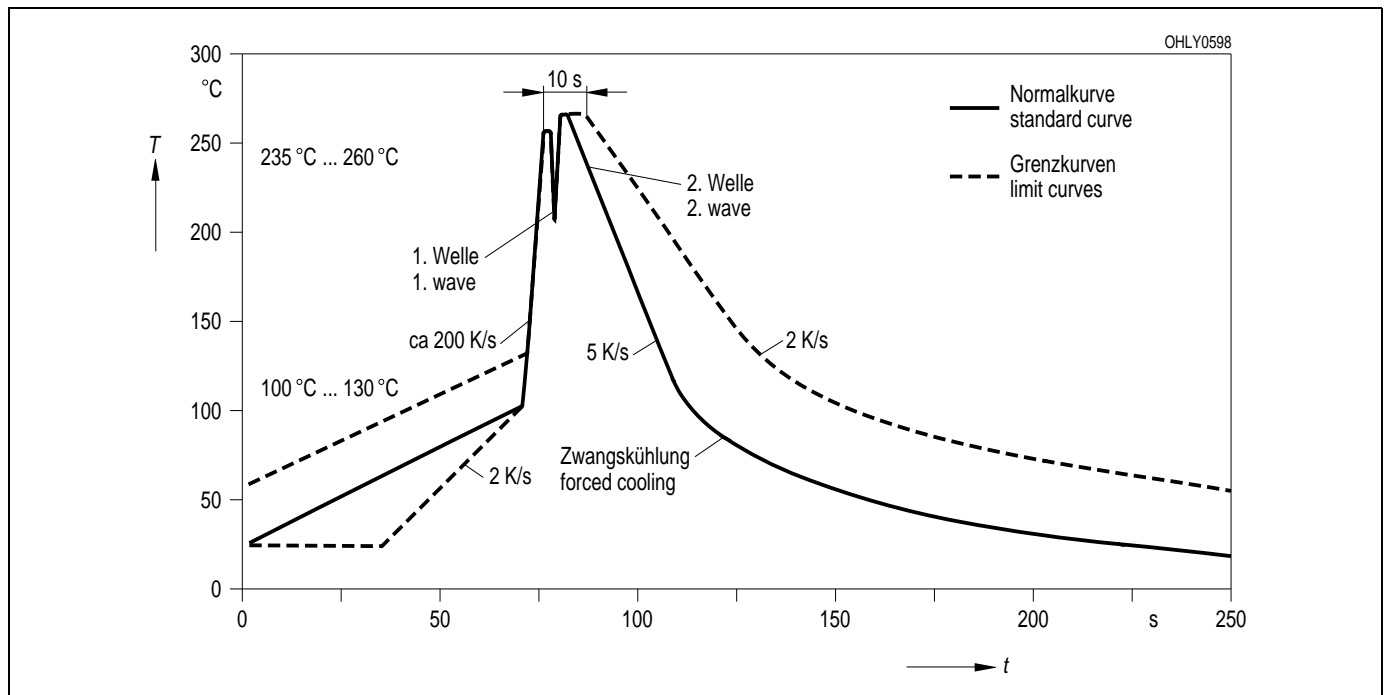

Published by
OSRAM Opto Semiconductors GmbH
Wernerwerkstrasse 2, D-93049 Regensburg
www.osram-os.com

© All Rights Reserved.

The information describes the type of component and shall not be considered as assured characteristics. Terms of delivery and rights to change design reserved. Due to technical requirements components may contain dangerous substances. For information on the types in question please contact our Sales Organization.

Packing

Please use the recycling operators known to you. We can also help you – get in touch with your nearest sales office. By agreement we will take packing material back, if it is sorted. You must bear the costs of transport. For packing material that is returned to us unsorted or which we are not obliged to accept, we shall have to invoice you for any costs incurred.

Components used in life-support devices or systems must be expressly authorized for such purpose! Critical components¹, may only be used in life-support devices or systems² with the express written approval of OSRAM OS.

¹ A critical component is a component used in a life-support device or system whose failure can reasonably be expected to cause the failure of that life-support device or system, or to affect its safety or effectiveness of that device or system.

² Life support devices or systems are intended (a) to be implanted in the human body, or (b) to support and/or maintain and sustain human life. If they fail, it is reasonable to assume that the health of the user may be endangered.

EU RoHS and China RoHS compliant product



此产品符合欧盟 RoHS 指令的要求；

按照中国的相关法规和标准，不含有毒有害物质或元素。