

Excellent Integrated System Limited

Stocking Distributor

Click to view price, real time Inventory, Delivery & Lifecycle Information:

[Avago Technologies US, Inc.](#)
[HLMP-MD16-MQT00](#)

For any questions, you can email us directly:

sales@integrated-circuit.com

Agilent HLMP-LD16/HLMP-MD16 4 mm Precision Optical Performance Red Oval LEDs Data Sheet

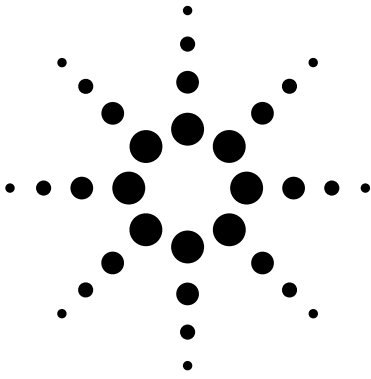

Description

These Precision Optical Performance Oval LEDs are specifically designed for Full Color/Video and Passenger Information signs. The oval shaped radiation pattern (50° x 100°) and high luminous intensity ensure that these devices are excellent for wide field of view outdoor applications where a wide viewing angle and readability in sunlight are essential. These lamps have very smooth, matched radiation patterns ensuring consistent color mixing in full color applications, message uniformity across the viewing angle of the sign.

High efficiency LED materials are used in these lamps: Aluminum Indium Gallium Phosphide (AlInGaP) for Red color. The higher performance AlInGaP II is used. Each lamp is made with an advanced optical grade epoxy offering superior high temperature and high moisture resistance in outdoor applications. The package epoxy contains both UV-a and UV-b inhibitors to reduce the effects of long term exposure to direct sunlight.

Designers can select parallel (where the axis of the leads is parallel to the wide axis of the oval radiation pattern) or perpendicular orientation. Both of the lamps are red diffused-tinted.

Features

- High brightness material
AlInGaP
630 nm Red
- Viewing angles:
major axis 100°
minor axis 50°
- Well defined spatial radiation pattern
- Superior resistance to moisture

Applications

- Commercial outdoor advertising
- Full color signs



Device Selection Guide AlInGaP2

Part Number	Color Dominant Wavelength λ_d (nm) Typ.	Luminous Intensity I_v (mcd) at 20 mA		Tinting Type	Leadframe Orientation	Package Drawing
		Min.	Max.			
HLMP-MD16-MQ000	Red 630	450	1730	Red	Perpendicular	A
HLMP-MD16-MQT00	Red 630	450	1730	Red	Perpendicular	A
HLMP-LD16-MQ000	Red 630	450	1730	Red	Parallel	B
HLMP-LD16-MQT00	Red 630	450	1730	Red	Parallel	B
HLMP-MD16-LP000	Red 630	345	1330	Red	Perpendicular	A
HLMP-MD16-LPT00	Red 630	345	1330	Red	Perpendicular	A
HLMP-LD16-LP000	Red 630	345	1330	Red	Parallel	B
HLMP-LD16-LPT00	Red 630	345	1330	Red	Parallel	B

Notes:

1. The luminous intensity is measured on the mechanical axis of the lamp package.
2. The optical axis is closely aligned with the package mechanical axis.
3. The dominant wavelength, λ_d , is derived from the CIE Chromaticity Diagram and represents the color of the lamp.

Package Dimensions

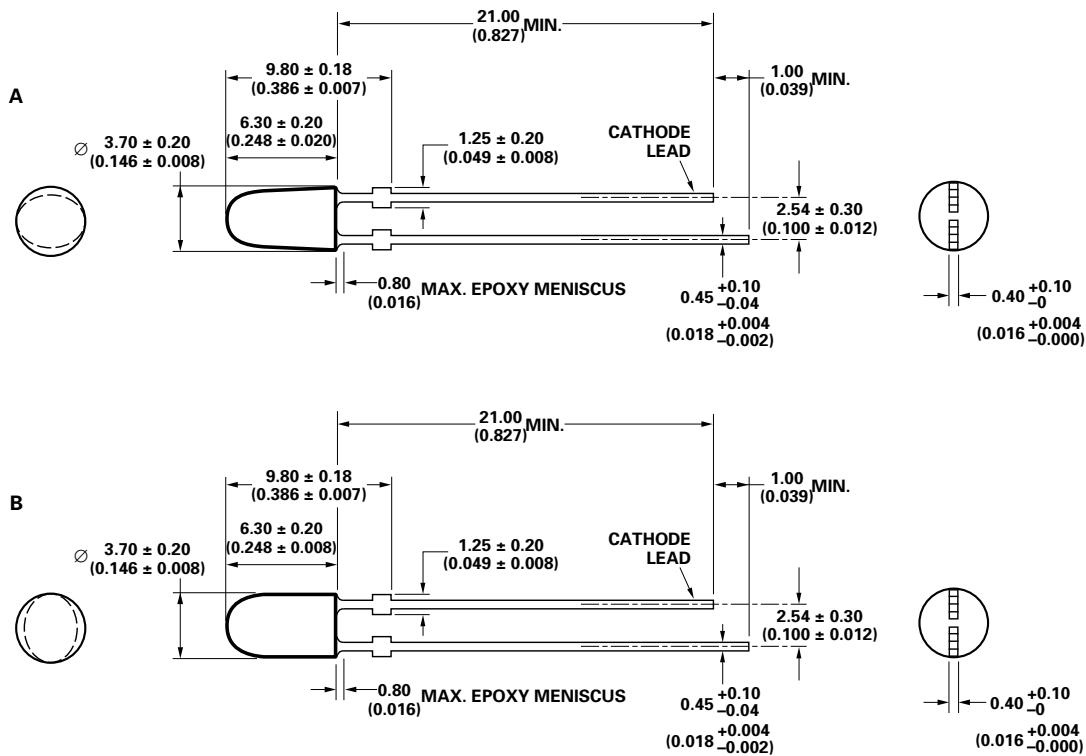

Notes:

1. Dimensions in millimeters (inches).
2. Tolerance ± 0.1 mm unless otherwise noted.

Part Numbering System

HLMP - x x xx - x x x xx

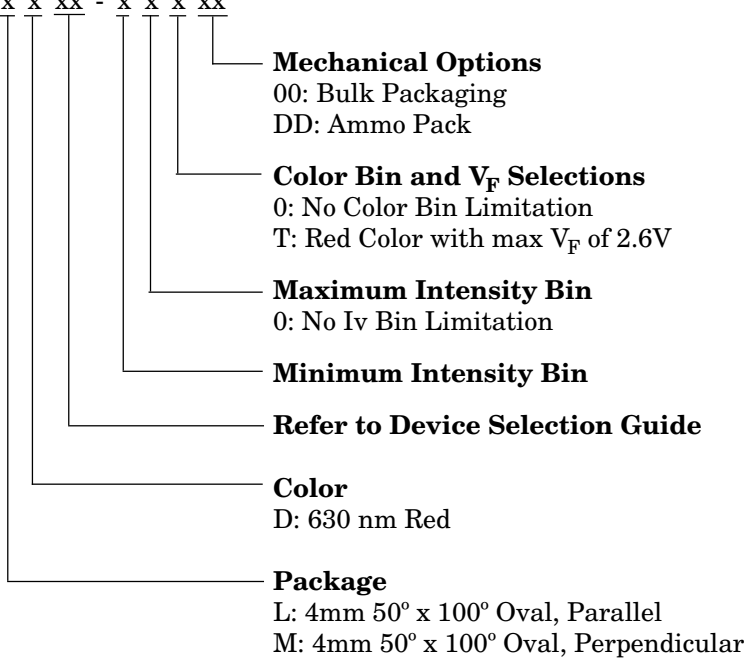

Absolute Maximum Ratings

$T_A = 25^\circ\text{C}$

Parameter	AllInGaP Value	Units
DC Forward Current ^[1]	50	mA
Peak Forward Current	100	mA
Average Forward Current	30	mA
Power Dissipation	120	mW
Reverse Voltage ($I_R = 100 \mu\text{A}$)	5	V
LED Junction Temperature	130	°C
Operating Temperature Range	-40 to +100	°C
Storage Temperature Range	-40 to +120	°C
Soldering Temperature	260 for 5 sec	°C

Note:

1. Derate linearly as shown in Figure 3 for temperatures above 50°C.

Electrical/Optical Characteristics

T_A = 25°C

Parameter	Symbol	Min.	Typ.	Max.	Units	Test Conditions
Typical Viewing Angle						
Major	2θ _{1/2}		100		deg	
Minor			50			
Forward Voltage						
Red (λ _d = 630 nm)	V _F		2.0	2.4 ^[1]	V	I _F = 20 mA
Reverse Voltage						
Red	V _R	5	20		V	I _R = 100 μA
Peak Wavelength						
Red (λ _d = 630 nm)	λ _{peak}		639		nm	Peak of Wavelength of Spectral Distribution at I _F = 20 mA
Spectral Halfwidth						
Red (λ _d = 630 nm)	Δλ _{1/2}		17		nm	Wavelength Width at Spectral Distribution Power Point at I _F = 20 mA
Capacitance						
Red	C		40		pF	V _F = 0, F = 1 MHz
Thermal Resistance	Rθ _{J-PIN}		240		°C/W	LED Junction-to-Cathode Lead
Luminous Efficacy						
Red (λ _d = 630 nm)	η _v		155		lm/W	Emitted Luminous Power/ Emitted Radiant Power

Notes:

1. For option -xxTxx, maximum forward voltage, V_F is 2.6V.
2. 2θ_{1/2} is the off-axis angle where the luminous intensity is 1/2 the on-axis intensity.
3. The radiant intensity, I_e in watts per steradian, may be found from the equation I_e = I_v/η_v where I_v is the luminous intensity in candelas and η_v is the luminous efficacy in lumens/watt.

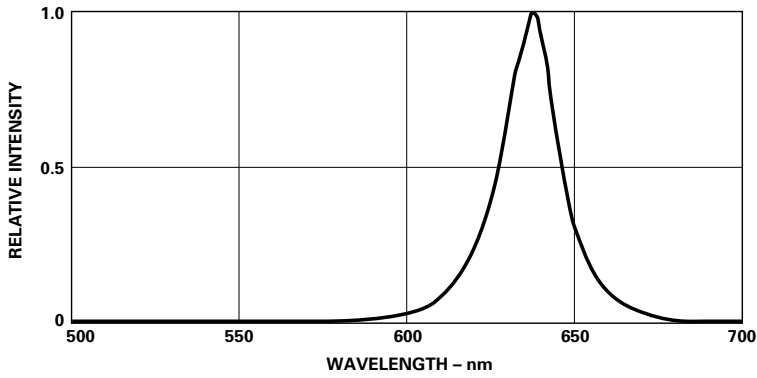

Figure 1. Relative intensity vs. wavelength.

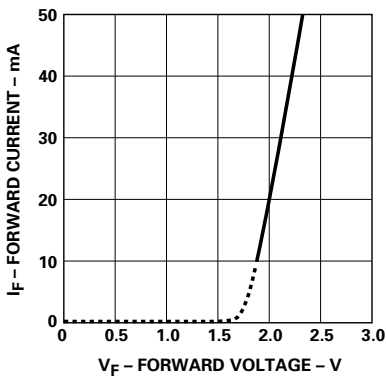

Figure 2. AllnGaP forward current vs. forward voltage.

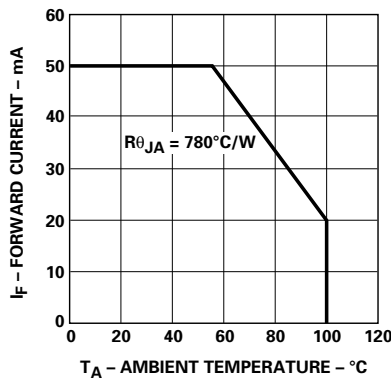

Figure 3. AllnGaP maximum forward current vs. ambient temperature.

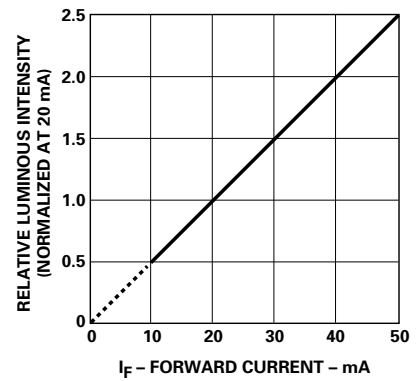

Figure 4. AllnGaP relative luminous intensity vs. forward current.

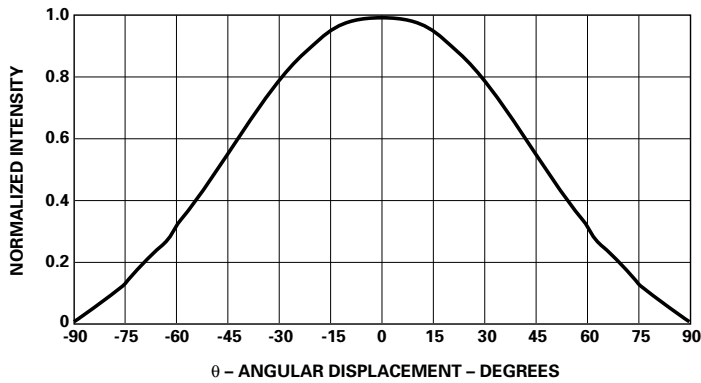

Figure 5a. Representative spatial radiation pattern – horizontal.

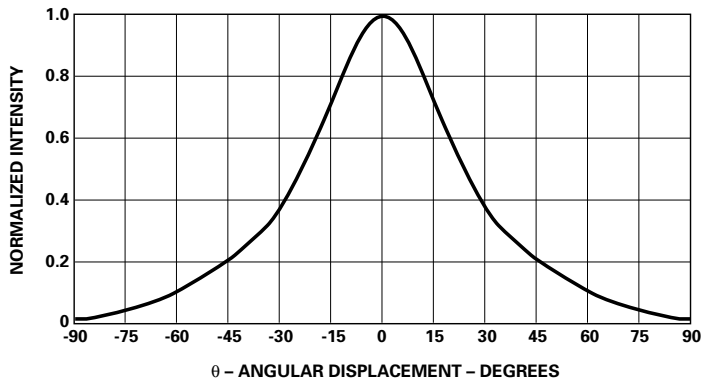

Figure 5b. Representative spatial radiation pattern – vertical.

Intensity Bin Limits

(mcd at 20 mA)

Bin Name	Min.	Max.
L	400	520
M	520	680
N	680	880
P	880	1150
Q	1150	1500

Tolerance for each bin limit is ± 15%.

Note:

1. Bin categories are established for classification of products. Products may not be available in all bin categories.

www.semiconductor.agilent.com

Data subject to change.
Copyright © 2001 Agilent Technologies Inc.
October 19, 2001
Obsoletes 5988-1854EN
5988-4351EN