

SERIES

# 8069

シールドロック H=3.0mm

SHIELD LOCK

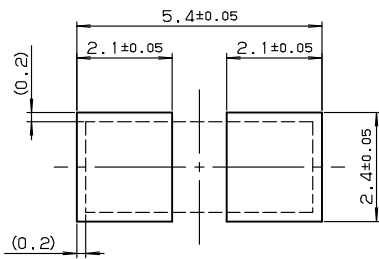

推奨パターンレイアウト  
RECOMMENDED PATTERN LAYOUT

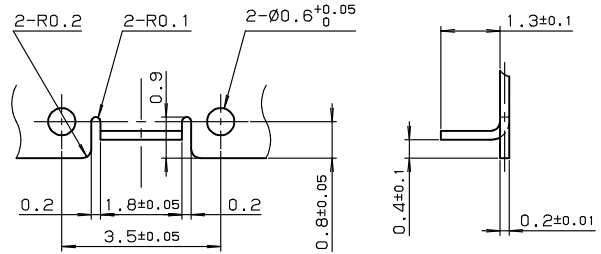

シールドケース形状  
SHIELDING CASE FORM

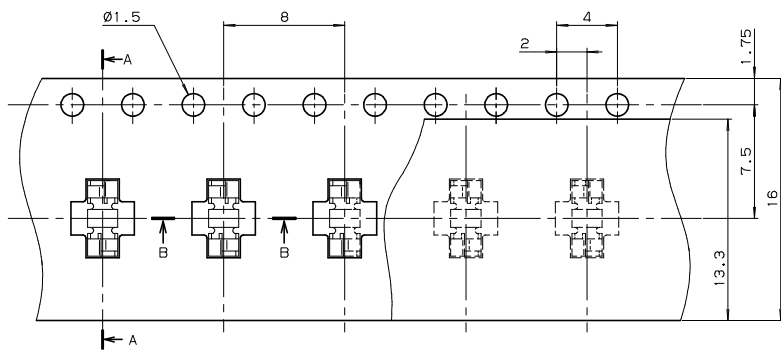
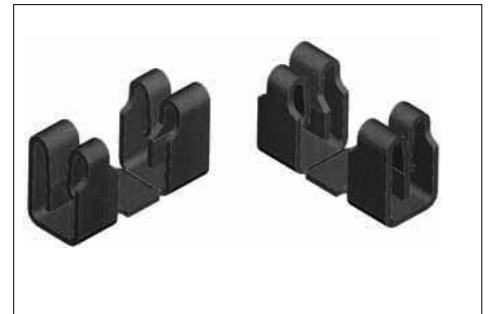
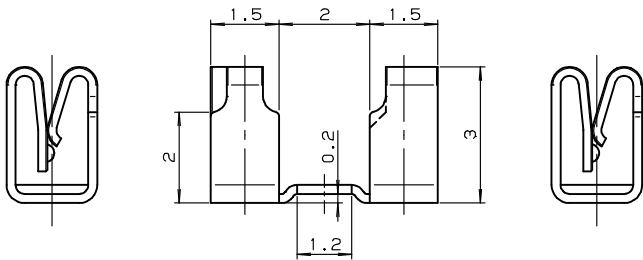
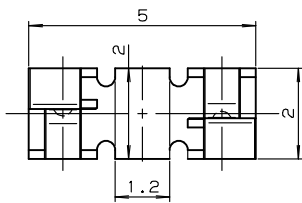

引出し方向

USED DIRECTION OF FEED

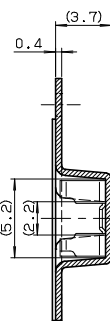

SECT. A-A

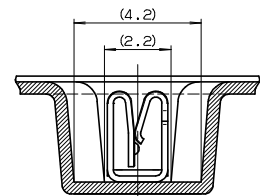

SECT. B-B

注文コード / Ordering Code

Part No. 04 8069 000 000 800 +

**KYOCERA**

KYOCERA Connector Products Corporation

SERIES

# 8069

シールドロック H=1.8mm

SHIELD LOCK

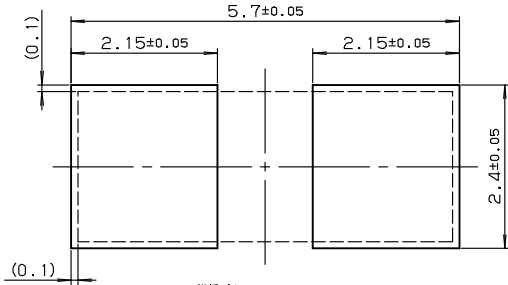

推奨パターンレイアウト  
RECOMMENDED PATTERN LAYOUT

シールドロック斜視図  
SHIELD LOCK

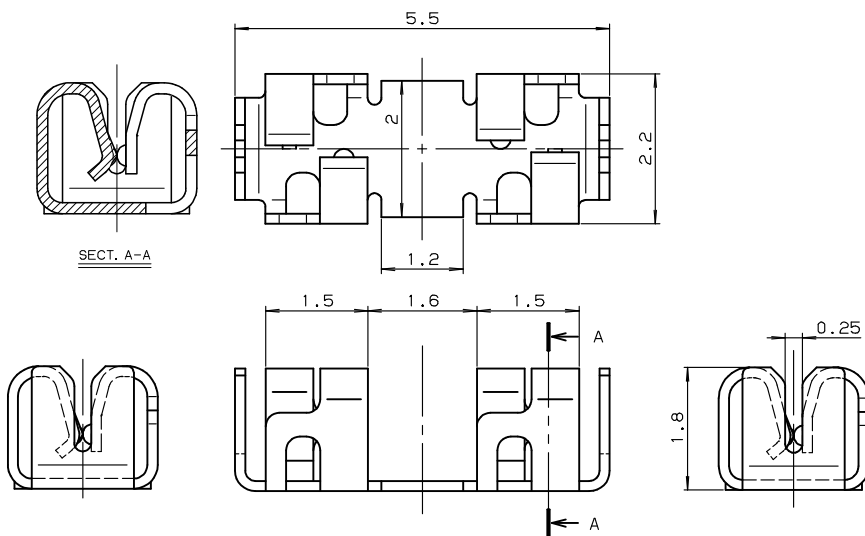
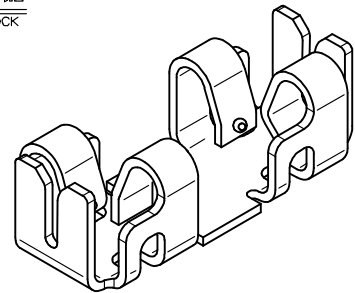

シールドロック嵌合状態斜視図  
SHIELD LOCK MATING

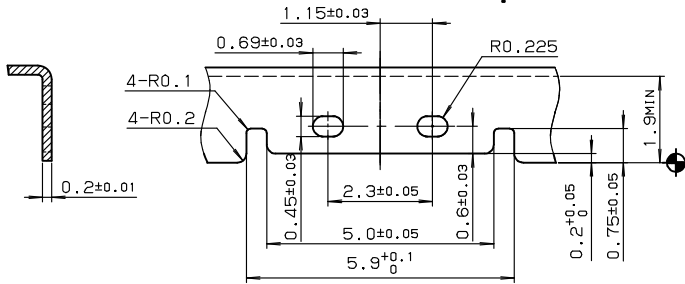
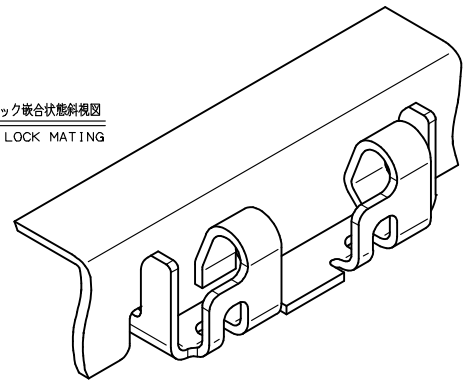

シールドケース形状  
SHIELDING CASE FORM

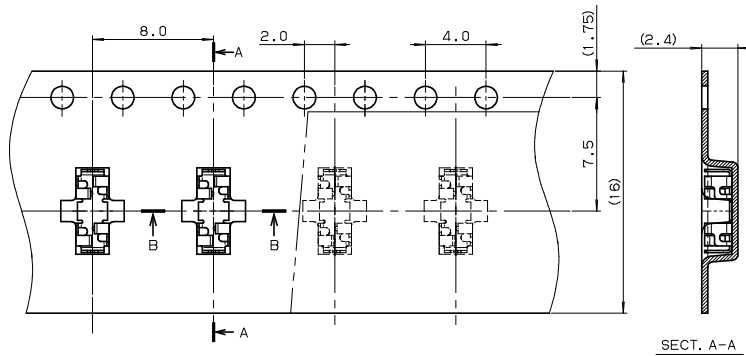

SECT. A-A

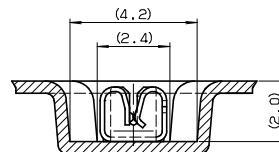

SECT. B-B

注文コード / Ordering Code

Part No. 04 8069 000 100 800 +



KYOCERA Connector Products Corporation