

Excellent Integrated System Limited

Stocking Distributor

Click to view price, real time Inventory, Delivery & Lifecycle Information:

[Infineon Technologies](#)

[SPP06N60C3](#)

For any questions, you can email us directly:

sales@integrated-circuit.com



SPP06N60C3

CoolMOS™ Power Transistor

Features

- New revolutionary high voltage technology
- Ultra low gate charge
- Periodic avalanche rated
- High peak current capability
- Ultra low effective capacitances
- Extreme dv/dt rated
- Improved transconductance

Product Summary

$V_{DS} @ T_{j,max}$	650	V
$R_{DS(on),max}$	0.75	Ω
I_D	6.2	A

PG-TO220-3-1

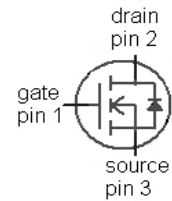
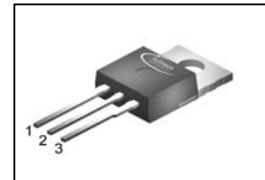

Type	Package	Ordering Code	Marking
SPP06N60C3	PG-TO220-3-1	Q67040-S4629	06N60C3

Maximum ratings, at $T_j=25\text{ °C}$, unless otherwise specified

Parameter	Symbol	Conditions	Value	Unit
Continuous drain current	I_D	$T_C=25\text{ °C}$	6.2	A
		$T_C=100\text{ °C}$	3.9	
Pulsed drain current ¹⁾	$I_{D,pulse}$	$T_C=25\text{ °C}$	18.6	
Avalanche energy, single pulse	E_{AS}	$I_D=3.1\text{ A}, V_{DD}=50\text{ V}$	200	mJ
Avalanche energy, repetitive t_{AR} ^{1),2)}	E_{AR}	$I_D=6.2\text{ A}, V_{DD}=50\text{ V}$	0.5	
Avalanche current, repetitive t_{AR} ¹⁾	I_{AR}		6.2	A
Drain source voltage slope	dv/dt	$I_D=6.2\text{ A}, V_{DS}=480\text{ V}, T_j=125\text{ °C}$	50	V/ns
Gate source voltage	V_{GS}	static	± 20	V
	V_{GS}	AC ($f > 1\text{ Hz}$)	± 30	
Power dissipation	P_{tot}	$T_C=25\text{ °C}$	74	W
Operating and storage temperature	T_j, T_{stg}		-55 ... 150	$^{\circ}\text{C}$



SPP06N60C3

Parameter	Symbol	Conditions	Values			Unit
			min.	typ.	max.	

Thermal characteristics

Thermal resistance, junction - case	R_{thJC}		-	-	1.7	K/W
Thermal resistance, junction - ambient	R_{thJA}	leaded	-	-	62	
	R_{thJA}	SMD version, device on PCB, minimal footprint	-	-	62	
		SMD version, device on PCB, 6 cm ² cooling area ³⁾	-	35	-	
Soldering temperature ⁴⁾	T_{sold}	1.6 mm (0.063 in.) from case for 10 s	-	-	260	°C

Electrical characteristics, at $T_j=25$ °C, unless otherwise specified

Static characteristics

Drain-source breakdown voltage	$V_{(BR)DSS}$	$V_{GS}=0$ V, $I_D=250$ μ A	600	-	-	V
Avalanche breakdown voltage	$V_{(BR)DS}$	$V_{GS}=0$ V, $I_D=6.2$ A	-	700	-	
Gate threshold voltage	$V_{GS(th)}$	$V_{DS}=V_{GS}$, $I_D=0.26$ mA	2.1	3	3.9	
Zero gate voltage drain current	I_{DSS}	$V_{DS}=600$ V, $V_{GS}=0$ V, $T_j=25$ °C	-	0.1	1	μ A
		$V_{DS}=600$ V, $V_{GS}=0$ V, $T_j=150$ °C	-	-	100	
Gate-source leakage current	I_{GSS}	$V_{GS}=20$ V, $V_{DS}=0$ V	-	-	100	nA
Drain-source on-state resistance	$R_{DS(on)}$	$V_{GS}=10$ V, $I_D=3.9$ A, $T_j=25$ °C	-	0.68	0.75	Ω
		$V_{GS}=10$ V, $I_D=3.9$ A, $T_j=150$ °C	-	1.82	-	
Gate resistance	R_G	$f=1$ MHz, open drain	-	1	-	
Transconductance	g_{fs}	$ V_{DS} >2 I_D R_{DS(on)max}$, $I_D=3.9$ A	-	5.6	-	S



SPP06N60C3

Parameter	Symbol	Conditions	Values			Unit
			min.	typ.	max.	

Dynamic characteristics

Input capacitance	C_{iss}	$V_{GS}=0\text{ V}, V_{DS}=25\text{ V},$ $f=1\text{ MHz}$	-	620	-	pF
Output capacitance	C_{oss}		-	200	-	
Reverse transfer capacitance	C_{rss}		-	17	-	
Effective output capacitance, energy related ⁵⁾	$C_{o(er)}$	$V_{GS}=0\text{ V}, V_{DS}=0\text{ V}$ to 480 V	-	28	-	
Effective output capacitance, time related ⁶⁾	$C_{o(tr)}$		-	47	-	
Turn-on delay time	$t_{d(on)}$	$V_{DD}=480\text{ V},$ $V_{GS}=10\text{ V}, I_D=6.2\text{ A},$ $R_G=12\ \Omega$	-	7	-	ns
Rise time	t_r		-	12	-	
Turn-off delay time	$t_{d(off)}$		-	52	-	
Fall time	t_f		-	10	-	

Gate Charge Characteristics

Gate to source charge	Q_{gs}	$V_{DD}=480\text{ V}, I_D=6.2\text{ A},$ $V_{GS}=0\text{ to }10\text{ V}$	-	3.3	-	nC
Gate to drain charge	Q_{gd}		-	12	-	
Gate charge total	Q_g		-	24	31	
Gate plateau voltage	$V_{plateau}$		-	5.5	-	V

¹⁾ Pulse width limited by maximum temperature $T_{j,max}$ only

²⁾ Repetitive avalanche causes additional power losses that can be calculated as $P_{AV}=E_{AR} \cdot f$.

³⁾ Device on 40 mm x 40 mm x 1.5 mm epoxy PCB FR4 with 6 cm² (one layer, 70 μm thick) copper area for drain connection. PCB is vertical in still air.

⁴⁾ Soldering temperature for TO263: 220 °C, reflow

⁵⁾ $C_{o(er)}$ is a fixed capacitance that gives the same stored energy as C_{oss} while V_{DS} is rising from 0 to 80% V_{DSS} .

⁶⁾ $C_{o(tr)}$ is a fixed capacitance that gives the same charging time as C_{oss} while V_{DS} is rising from 0 to 80% V_{DSS} .



SPP06N60C3

Parameter	Symbol	Conditions	Values			Unit
			min.	typ.	max.	

Reverse Diode

Diode continuous forward current	I_S	$T_C=25\text{ }^\circ\text{C}$	-	-	6.2	A
Diode pulse current	$I_{S,pulse}$		-	-	18.6	
Diode forward voltage	V_{SD}	$V_{GS}=0\text{ V}, I_F=6.2\text{ A}, T_j=25\text{ }^\circ\text{C}$	-	0.97	1.2	V
Reverse recovery time	t_{rr}	$V_R=480\text{ V}, I_F=I_S, di_F/dt=100\text{ A}/\mu\text{s}$	-	400	-	ns
Reverse recovery charge	Q_{rr}		-	3.5	-	μC
Peak reverse recovery current	I_{rrm}		-	25	-	A

Typical Transient Thermal Characteristics

Symbol	Value	Unit	Symbol	Value	Unit
	typ.			typ.	
R_{th1}	0.0325	K/W	C_{th1}	0.0000502	Ws/K
R_{th2}	0.0448		C_{th2}	0.000303	
R_{th3}	0.251		C_{th3}	0.000428	
R_{th4}	0.31		C_{th4}	0.00243	
R_{th5}	0.301		C_{th5}	0.00526	
			C_{th6}	1.09 ⁷⁾	

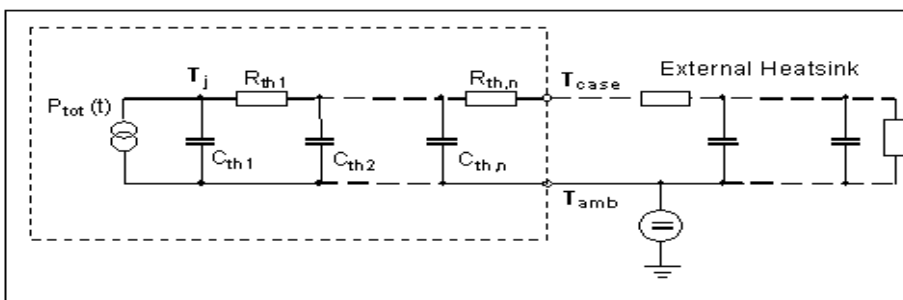

⁷⁾ C_{th6} models the additional heat capacitance of the package in case of non-ideal cooling. It is not needed if $R_{thCA}=0\text{ K/W}$.



SPP06N60C3

1 Power dissipation

$P_{tot}=f(T_C)$

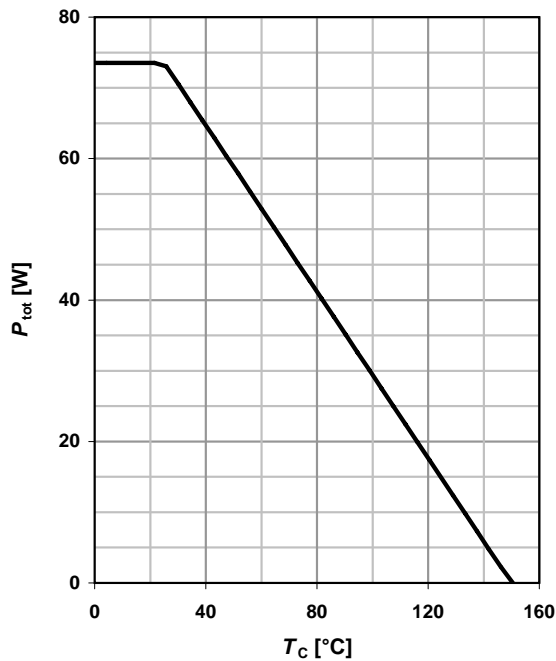

2 Safe operating area

$I_D=f(V_{DS}); T_C=25\text{ °C}; D=0$

parameter: t_p

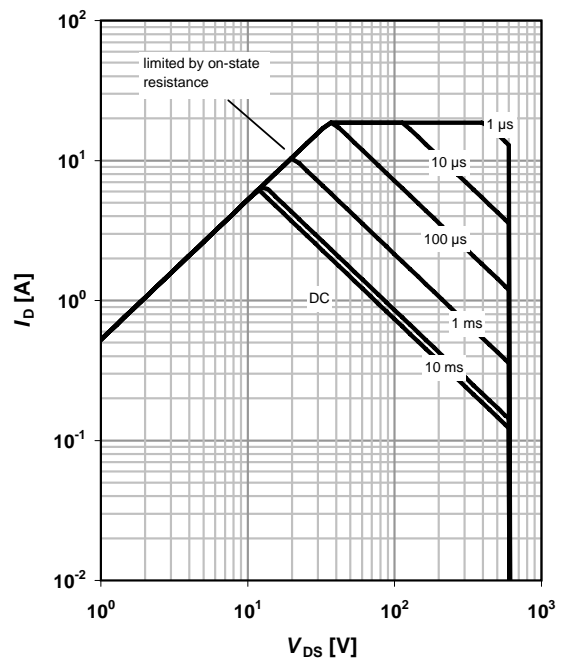

3 Max. transient thermal impedance

$I_D=f(V_{DS}); T_j=25\text{ °C}$

parameter: $D=t_p/T$

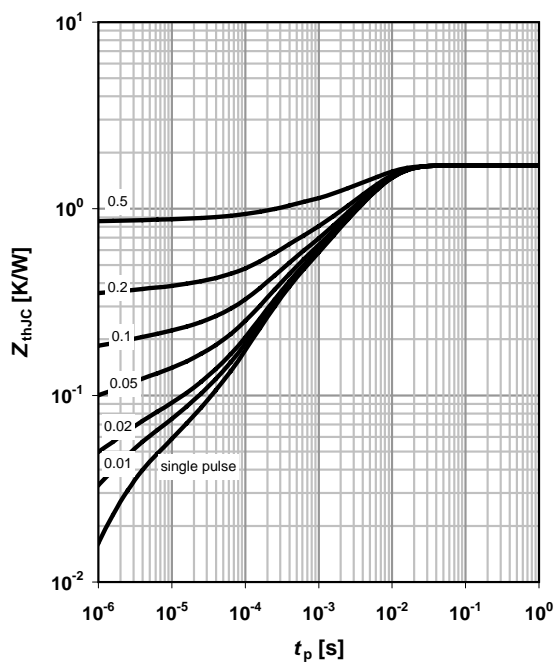

4 Typ. output characteristics

$I_D=f(V_{DS}); T_j=25\text{ °C}$

parameter: V_{GS}

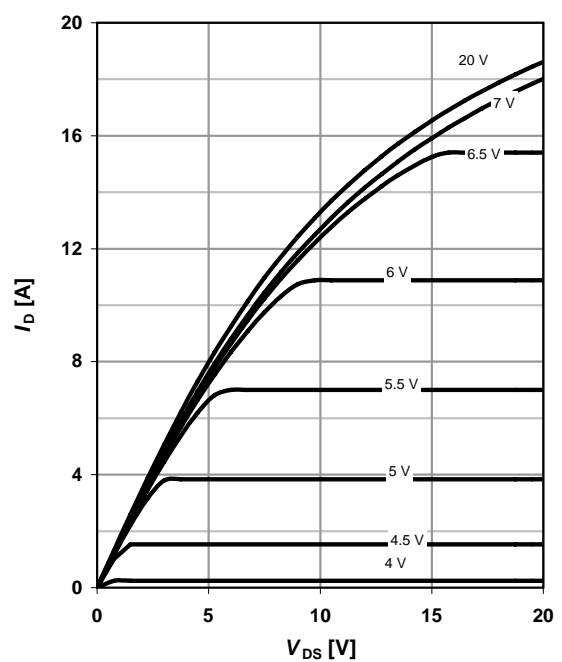



SPP06N60C3

5 Typ. output characteristics

$I_D = f(V_{DS}); T_j = 150\text{ }^\circ\text{C}$

parameter: V_{GS}

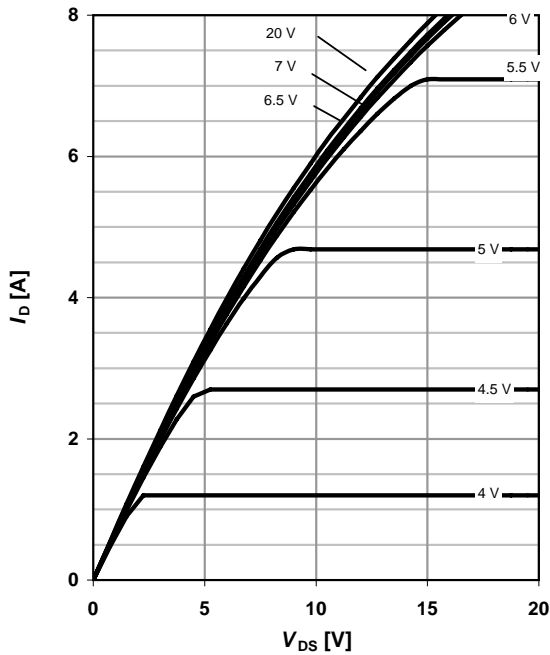

6 Typ. drain-source on-state resistance

$R_{DS(on)} = f(I_D); T_j = 150\text{ }^\circ\text{C}$

parameter: V_{GS}

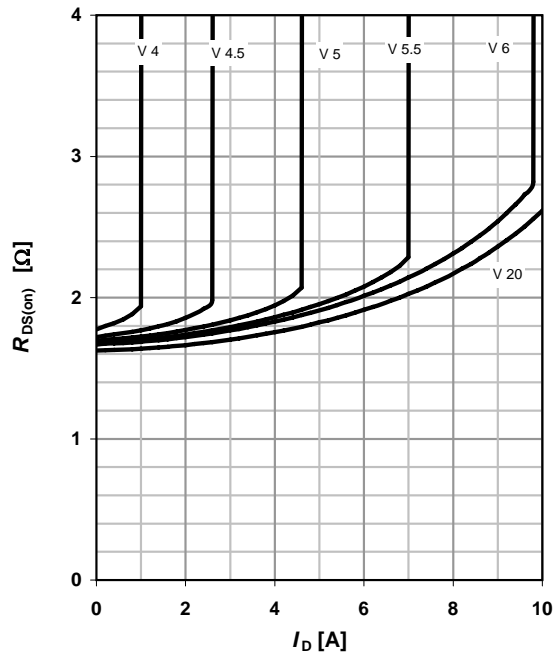

7 Drain-source on-state resistance

$R_{DS(on)} = f(T_j); I_D = 3.9\text{ A}; V_{GS} = 10\text{ V}$

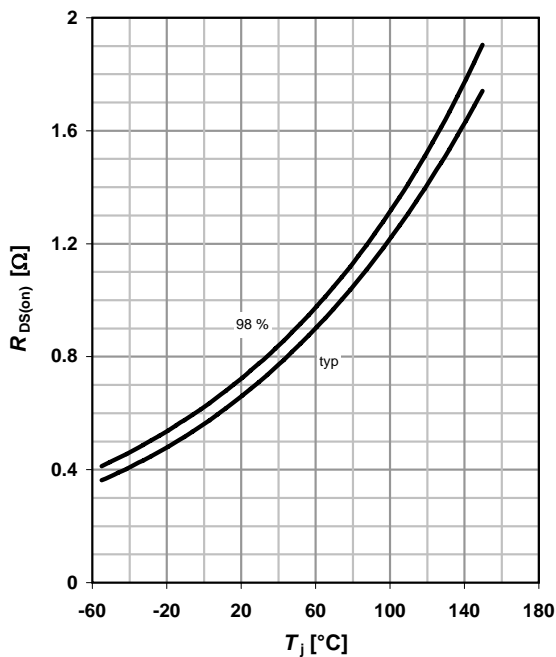

8 Typ. transfer characteristics

$I_D = f(V_{GS}); |V_{DS}| > 2|I_D|R_{DS(on)max}$

parameter: T_j

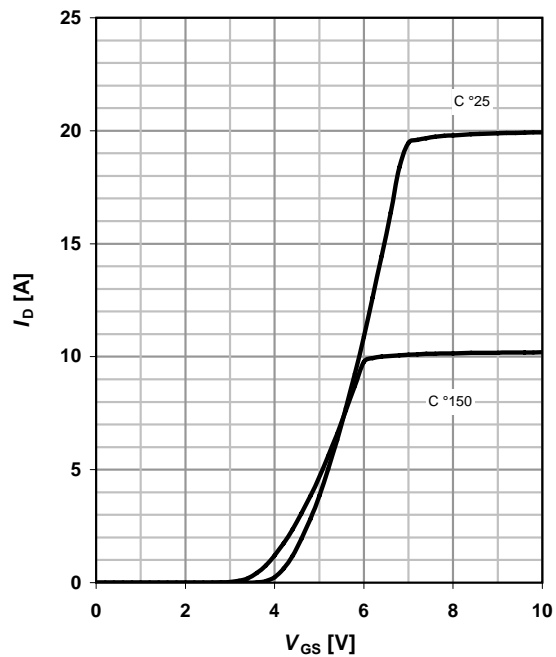



9 Typ. gate charge

$V_{GS}=f(Q_{gate}); I_D=6.2\text{ A pulsed}$

parameter: V_{DD}

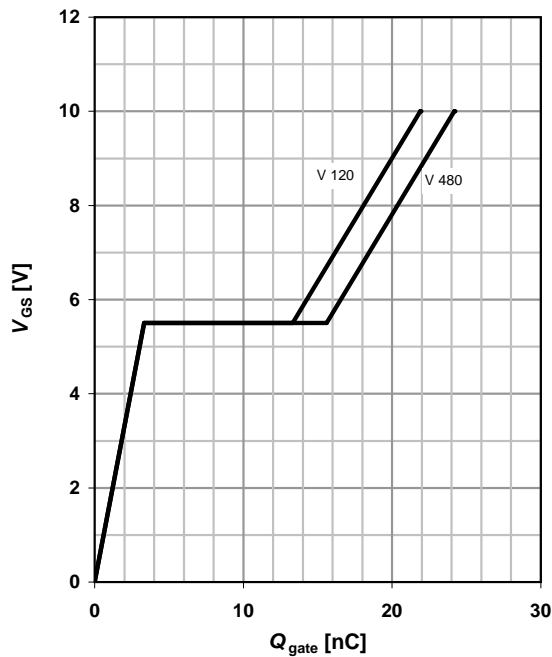

10 Forward characteristics of reverse diode

$I_F=f(V_{SD})$

parameter: T_j

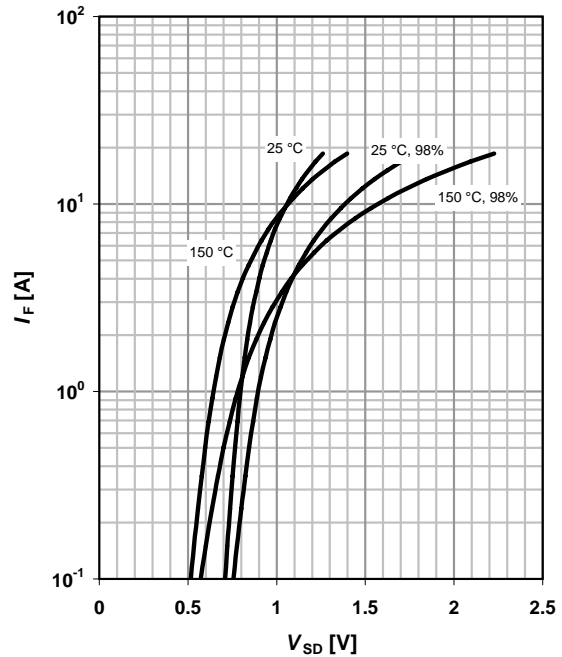

11 Avalanche SOA

$I_{AR}=f(t_{AR})$

parameter: $T_{j(start)}$

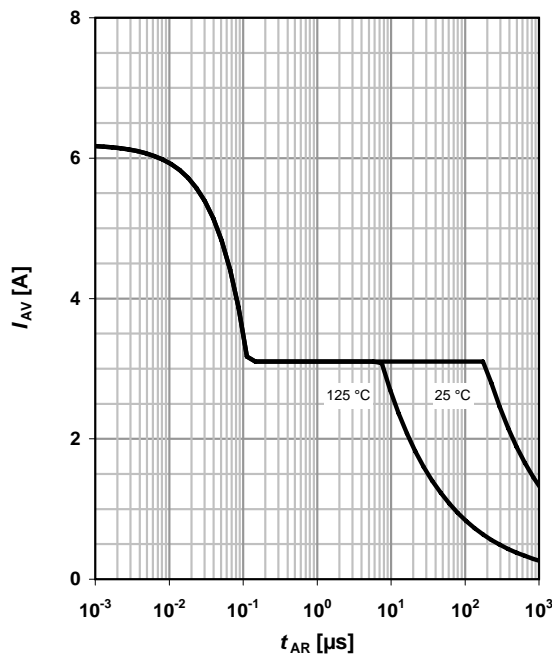

12 Avalanche energy

$E_{AS}=f(T_j); I_D=3.1\text{ A}; V_{DD}=50\text{ V}$

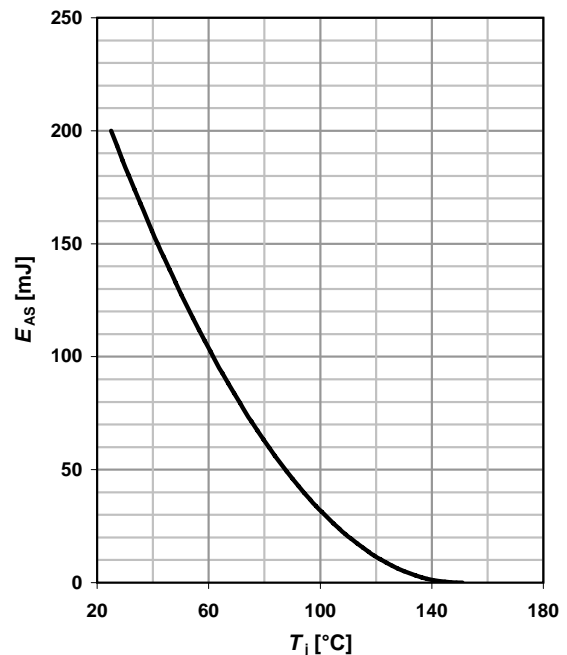



SPP06N60C3

13 Drain-source breakdown voltage

$V_{BR(DSS)}=f(T_j); I_D=0.25\text{ mA}$

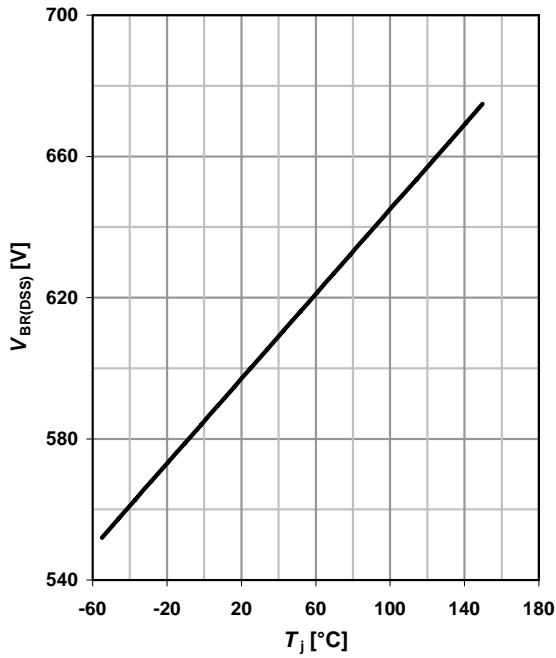

14 Typ. capacitances

$C=f(V_{DS}); V_{GS}=0\text{ V}; f=1\text{ MHz}$

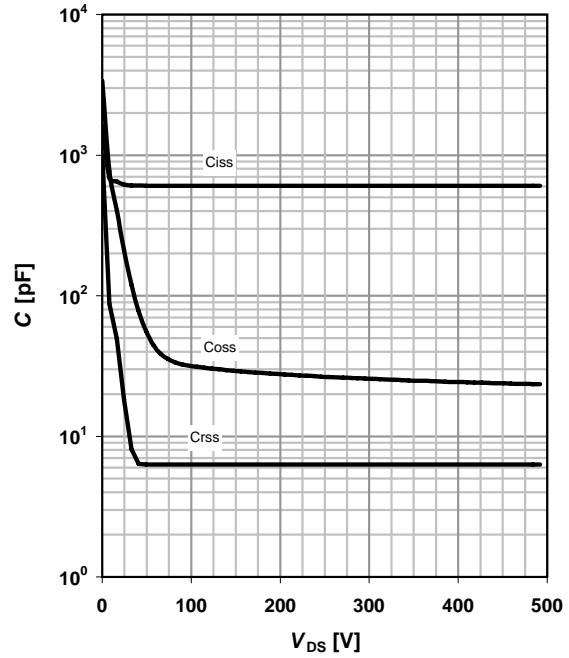

15 Typ. C_{oss} stored energy

$E_{oss}=f(V_{DS})$

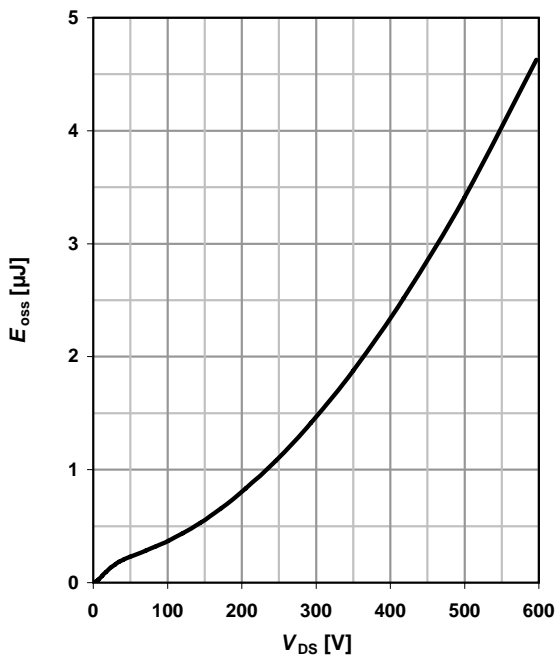



SPP06N60C3

Definition of diode switching characteristics

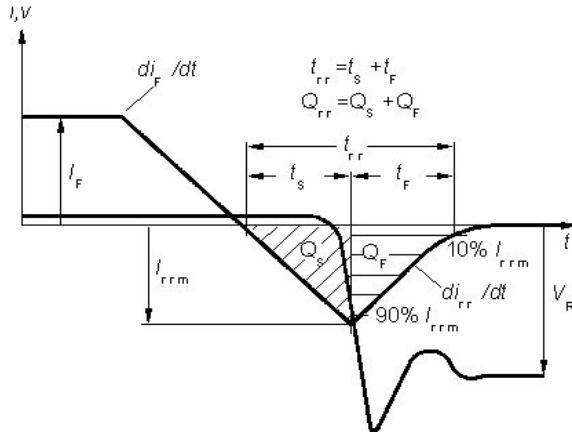



SPP06N60C3

PG-TO220-3-1

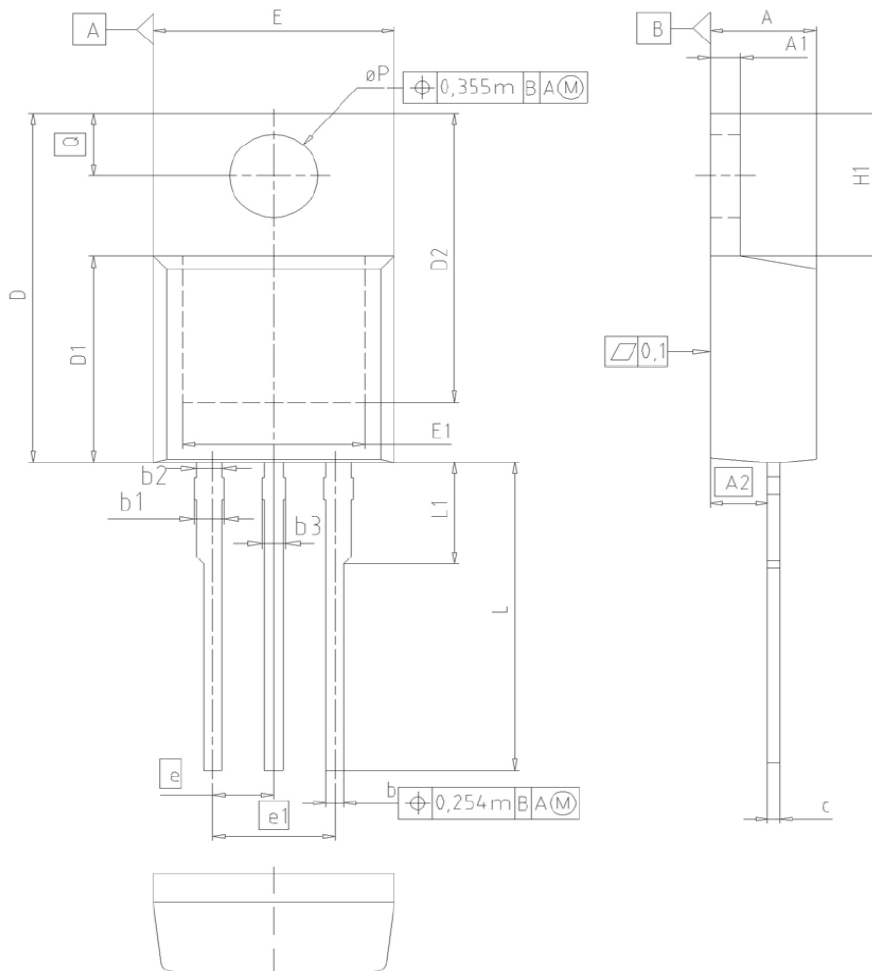

DIM	MILLIMETERS		INCHES	
	MIN	MAX	MIN	MAX
A	4.30	4.57	0.169	0.180
A1	1.17	1.40	0.046	0.055
A2	2.15	2.72	0.085	0.107
b	0.65	0.86	0.026	0.034
b1	0.95	1.40	0.037	0.055
b2	0.95	1.15	0.037	0.045
b3	0.65	1.15	0.026	0.045
c	0.33	0.60	0.013	0.024
D	14.81	15.95	0.583	0.628
D1	8.51	9.45	0.335	0.372
D2	12.19	13.10	0.480	0.516
E	9.70	10.36	0.382	0.408
E1	6.50	8.60	0.256	0.339
e	2.54		0.100	
e1	5.08		0.200	
N	3		3	
H1	5.90	6.90	0.232	0.272
L	13.00	14.00	0.512	0.551
L1	-	4.80	-	0.189
øP	3.60	3.89	0.142	0.153
Q	2.60	3.00	0.102	0.118

DOCUMENT NO.
Z8B00003318

SCALE

EUROPEAN PROJECTION

ISSUE DATE
23-08-2007

REVISION
05



Published by

Infineon Technologies AG

81726 Munich, Germany

© 2009 Infineon Technologies AG

All Rights Reserved.

Legal Disclaimer

The information given in this document shall in no event be regarded as a guarantee of conditions or characteristics. With respect to any examples or hints given herein, any typical values stated herein and/or any information regarding the application of the device, Infineon Technologies hereby disclaims any and all warranties and liabilities of any kind, including without limitation, warranties of non-infringement of intellectual property rights of any third party.

Information

For further information on technology, delivery terms and conditions and prices, please contact the nearest Infineon Technologies Office (www.infineon.com).

Warnings

Due to technical requirements, components may contain dangerous substances. For information on the types in question, please contact the nearest Infineon Technologies Office.

Infineon Technologies components may be used in life-support devices or systems only with the express written approval of Infineon Technologies, if a failure of such components can reasonably be expected to cause the failure of that life-support device or system or to affect the safety or effectiveness of that device or system. Life support devices or systems are intended to be implanted in the human body or to support and/or maintain and sustain and/or protect human life. If they fail, it is reasonable to assume that the health of the user or other persons may be endangered.