

Excellent Integrated System Limited

Stocking Distributor

Click to view price, real time Inventory, Delivery & Lifecycle Information:

[Murata Power Solutions Inc.](#)
[MPD5S025S](#)

For any questions, you can email us directly:
sales@integrated-circuit.com

DC-DC Converter Application Manual

MPD5S025S

1. Features

- 3-output module designed for data-processing devices requiring multiple dc-power lines such as FPGA.
- Vertical SIP configuration saves PCB space.
- Wide adjustable output voltage range.
(Vout1: 1.0V to 3.3V, Vout2: 1.8V to 3.6V)
- Remote ON/OFF (Positive Logic)
- Short Circuit Protection .

2. Appearance, Dimensions

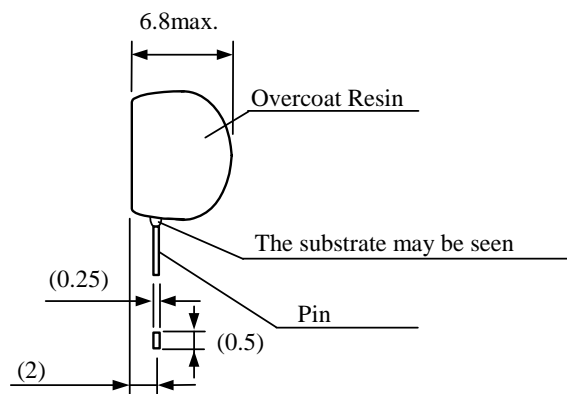
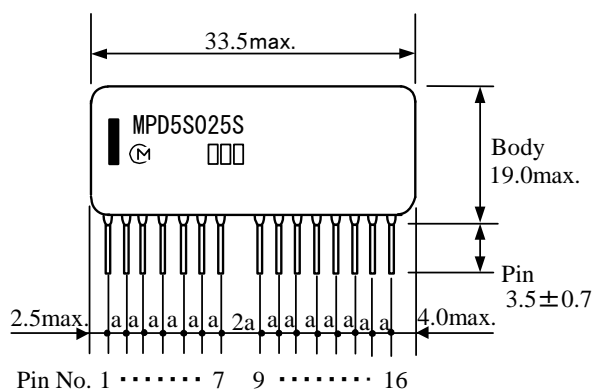

Unit
 ()...reference value
 Pin Pitch a= 1.8 ±0.3mm

Expanded Schematic of PinTerminal edge

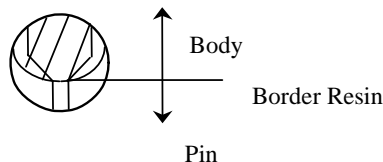

Markings

(1) 1 Pin Marking



(2) Part No.

MPD5S025S

(3) MFG ID



(4) Lot No.



(a)(b)(c)

(a) Production Factory

(b) Production Year

(c) Production Month(1,2,3, ---- 9,O,N,D)

⚠ Note:

1. This datasheet is downloaded from the website of Murata Manufacturing co., ltd. Therefore, it's specifications are subject to change or our products in it may be discontinued without advance notice. Please check with our sales representatives or product engineers before ordering.
2. This datasheet has only typical specifications because there is no space for detailed specifications. Therefore, please approve our product specifications or transact the approval sheet for product specifications before ordering.

Pin Number and Function

Pin No.	Function	Pin No.	Function
1.	Vin	9.	GND
2.	N.C.(Internally Used)	10.	Vout1(1.0V-3.3V)
3.	ON/OFF2	11.	Vout1(1.0V-3.3V)
4.	VAR2	12.	GND
5.	GND	13.	VAR1
6.	Vout2(1.8V-3.6V)	14.	ON/OFF1
7.	Vout3(2.5V)	15.	Vin
		16.	N.C.(Internally Used)

GND terminals and Vin terminals are NOT connected inside of this device. These pins should be connected to one-another externally.

The path-distance between your GND and GND terminals of this device, and your Vin and Vin terminals of this device should be minimized as much as possible on your product's assembly.

N.C. (Pin No.2 and No.16) are utilized internally. These pins should be left open.

3. Block Diagram

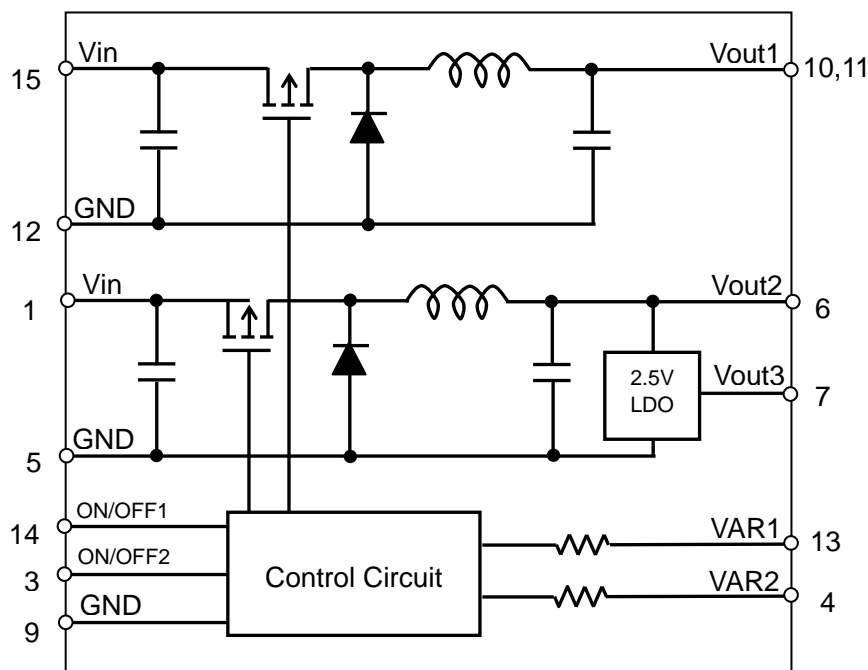



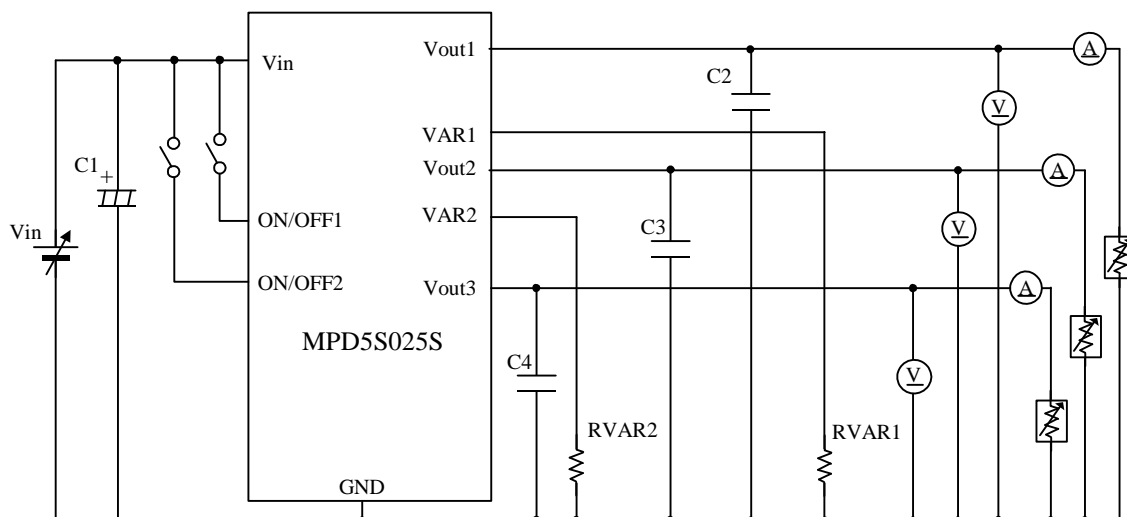

Note:

1. This datasheet is downloaded from the website of Murata Manufacturing co., ltd. Therefore, it's specifications are subject to change or our products in it may be discontinued without advance notice. Please check with our sales representatives or product engineers before ordering.
2. This datasheet has only typical specifications because there is no space for detailed specifications. Therefore, please approve our product specifications or transact the approval sheet for product specifications before ordering.

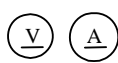
4. Test Circuit



	: Digital Multi meter	HP34401A equivalent	(Agilent Technologies)
	: Ripple Voltmeter	RM-101 equivalent	(Keisokugiken)
	: Electronic Load Device	EUL-150 α XL equivalent	(Fujitsu access)
	: DC Power Supply	HP6621A equivalent	(Agilent Technologies)

C1 : Low Impedance Aluminum Electrolytic Capacitor 220μF/16V (ZL series : Rubycon)

C2,C3,C4 : Ceramic Capacitor 1μF/10V/X7R (GRM188R71A105KA61: MURATA)

RVAR1,RVAR2 : Chip Resistor ±0.5%, 1/16W

Note:

1. This datasheet is downloaded from the website of Murata Manufacturing co., ltd. Therefore, it's specifications are subject to change or our products in it may be discontinued without advance notice. Please check with our sales representatives or product engineers before ordering.
2. This datasheet has only typical specifications because there is no space for detailed specifications. Therefore, please approve our product specifications or transact the approval sheet for product specifications before ordering.

5. Characteristics
 5-1 . Electrical Characteristics (Ta=25 °C)

Item	Symbol	Condition	Value			Unit	
			Min.	Typ.	Max.		
Input Voltage	Vin		4.5	5	5.5	V	
Output Voltage	Vout1	Vin=4.5-5.5V (Vin-Vo>1V)	1.0		3.3	V	
Adjustable Range	Vout2		1.8		3.6		
Output Voltage Accuracy	Vout1	RVAR1=2.285kΩ±0.5%	+1.14	+1.20	+1.25	V	
		RVAR1=10.683kΩ±0.5%	+1.73	+1.80	+1.87		
	Vout2	RVAR2=1.80kΩ±0.5%	+3.20	+3.30	+3.40		
	Vout3	Vo≥2.85V(*1)	+2.375	+2.50	+2.625		
Load Current	lout1		0	-	1.6	A	
	lout2						
	+lout3	Current sum of lout2 and lout3 (*2)	0	-	1.6		
	lout3	Vout2≥3.05V	0	-	0.30		
	lout3	3.05V>Vout2≥2.95V	0	-	0.25		
		2.95V>Vout2≥2.85V	0	-	0.20		
2.95V>Vout2≥2.85V		0	-	0.20			
Continuous Load Current			See thermal derating curve in section 5.3			A	
Ripple Voltage	Vrip1	Vin=5V, lout3=0.3A Vout1=1.2V, lout1=1.6A, Vout2=3.3V, lout2=1.3A BW=20MHz, Cout=1μF	-	50	-	mV(p-p)	
	Vrip2		-	50	-		
Efficiency	EFF	Vin=5V, lout3=0.3A Vout1=1.2V, lout1=1.6A, Vout2=3.3V, lout2=1.3A	-	82	-	%	
Remote ON/OFF	ON/OFF1	Vin=4.5-5.5V	ON	+2.5	-	Vin	V
	ON/OFF2		OFF	0	-	+0.5	
Frequency	Freq.		-	750	-	kHz	
External Output Capacitor	Cout	MLCC (ESR≤50mΩ)	0	1	47	μF	
		Electrolytic, Polymer (ESR>50mΩ)	0	47	470	μF	
Protection Circuit	SCP	<p>Short circuit protection monitors output voltage. If the output voltage isn't regulated over 8msec (typ), the protection circuit assumes the output is shorted to GND and will shut down the DC-DC converter.</p> <p>This protection won't work as an over current protection, so the current limit of input power supply should be under 5A in order to avoid damage to this device.</p> <p>After correction of the abnormal condition, the DC-DC converter will restart by re-applying Vin or toggling ON/OFF pin.</p>					

Note (1) Vout3 is powered from Vout2 via an LDO inside of this converter. Consequently Vout2 must be 2.85V or more to achieve 2.5V at the Vout3 terminal. If Vout2 < 2.85V, Vout3 will be about 0.3V lower than Vout2.

(2) Vout3 is powered from Vout2 via an LDO inside of the converter. As a result the current that can be sourced from the Vout2 terminal is dependent on lout3. Please note that the lout2 limit decreases as lout3 increases, and vice versa.

⚠ Note:

- 1.This datasheet is downloaded from the website of Murata Manufacturing co., Ltd. Therefore, it's specifications are subject to change or our products in it may be discontinued without advance notice. Please check with our sales representatives or product engineers before ordering.
- 2.This datasheet has only typical specifications because there is no space for detailed specifications. Therefore, please approve our product specifications or transact the approval sheet for product specifications before ordering.

5-2 . Remote Timing Requirement for Start-up

The following condition should be met to start this device.

5-2-1 . Required Condition for Start-up without ON/OFF Control

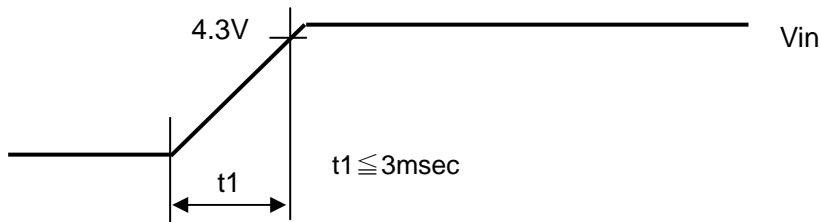

* ON/OFF1 and ON/OFF2 should be pulled up to V_{in} .

5-2-2 . Recommended Condition for Start-up with ON/OFF Control

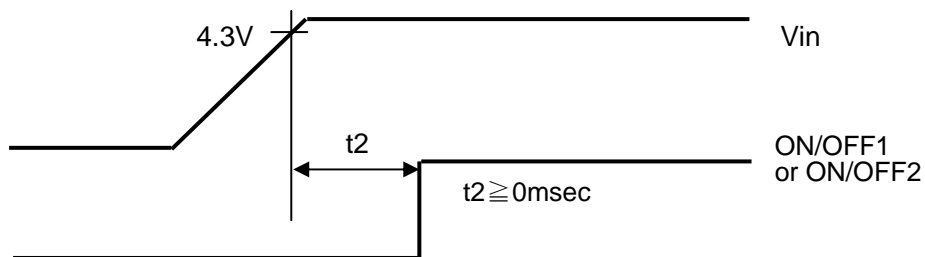

Note:

1. This datasheet is downloaded from the website of Murata Manufacturing co., ltd. Therefore, it's specifications are subject to change or our products in it may be discontinued without advance notice. Please check with our sales representatives or product engineers before ordering.
2. This datasheet has only typical specifications because there is no space for detailed specifications. Therefore, please approve our product specifications or transact the approval sheet for product specifications before ordering.

5-3 . Thermal Derating

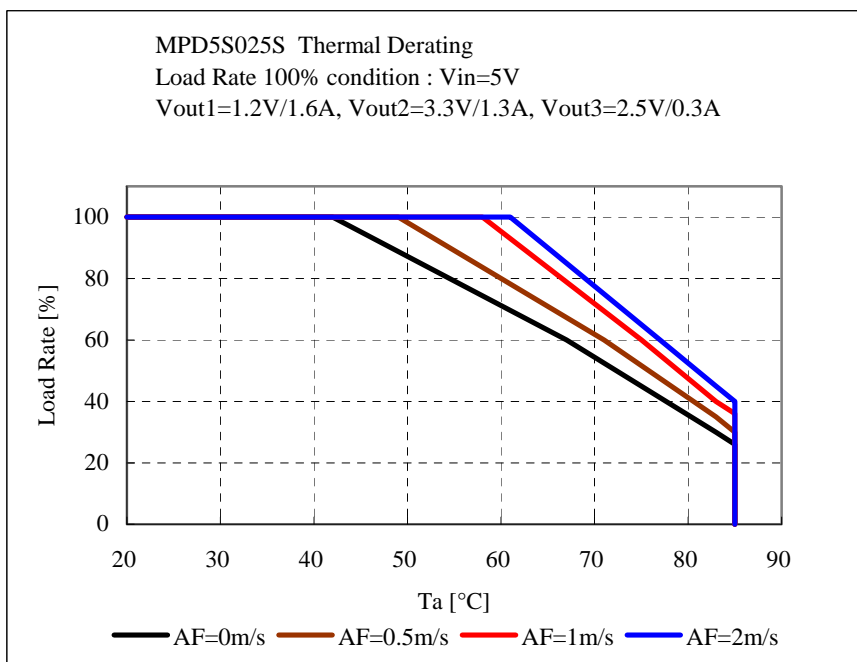
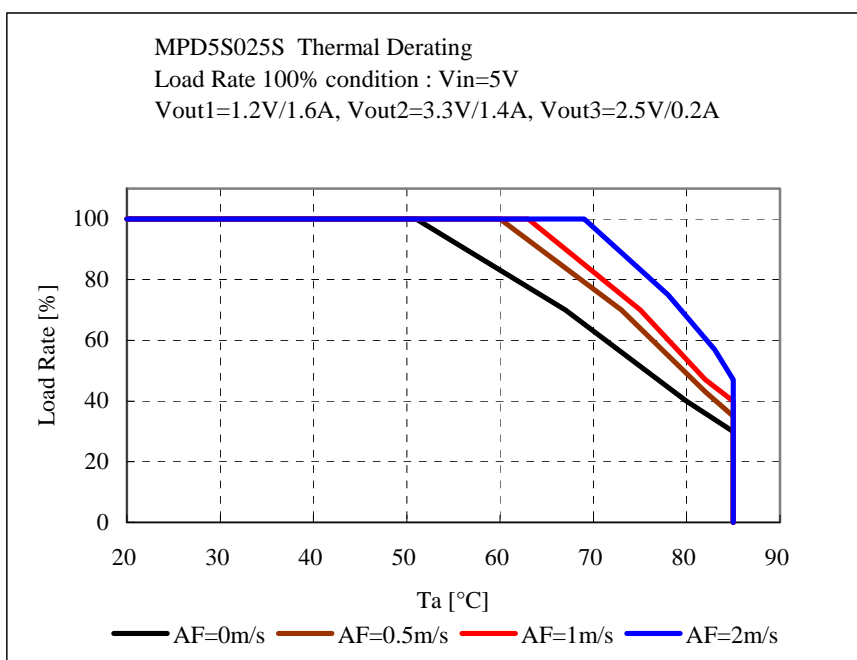

The above thermal derating should be considered a reference only due to dependencies on a variety of conditions such as PCB layout design, output voltage settings, current balance between each output, high temperature exposure from adjacent parts, etc.

For reliable operation, please ensure that the surface temperature of this product is maintained below 100°C.

⚠ Note:

1. This datasheet is downloaded from the website of Murata Manufacturing co., Ltd. Therefore, it's specifications are subject to change or our products in it may be discontinued without advance notice. Please check with our sales representatives or product engineers before ordering.
2. This datasheet has only typical specifications because there is no space for detailed specifications. Therefore, please approve our product specifications or transact the approval sheet for product specifications before ordering.

6. Pin Description

6-1. Output Voltage Trimming (Adjustment)

The output voltage of Vout1 and Vout2 can be adjusted by connecting a resistor between each VAR-pin (Pins 4 & 13) to a GND-pin (Pin 9 is recommended for the most accurate Vout setting). The following equation gives the required external-resistance value to adjust the output voltage to the required Vout.

< Output Voltage Calc.>

$$RVAR1 = \frac{24}{\frac{5.782}{Vout1} - 1.7273} - 5.479 \quad [k\Omega]$$

$$RVAR2 = \frac{15}{Vout2 - 1.8} - 8.197 \quad [k\Omega]$$

< RVAR Calculation Example >

Vout1[V]	Calculated RVAR1[Ω]	Applied RVAR1 (example) [Ω]
1.0	440	390+47
1.2	2285	2.2k+82
1.5	5803	5.6k+200
1.8	10683	10k+680
2.5	35512	33k+2.4k
3.0	114501	110k+4.7k
3.3	961436	1M

Vout2[V]	Calculated RVAR2[Ω]	Applied RVAR2 (example) [Ω]
1.8	∞	open
2.0	66803	62k+4.7k
2.5	13232	13k+240
3.0	4303	4.3k
3.3	1803	1.8k
3.6	136	130

Note:

1. This datasheet is downloaded from the website of Murata Manufacturing co., ltd. Therefore, it's specifications are subject to change or our products in it may be discontinued without advance notice. Please check with our sales representatives or product engineers before ordering.
2. This datasheet has only typical specifications because there is no space for detailed specifications. Therefore, please approve our product specifications or transact the approval sheet for product specifications before ordering.

6-2. Remote ON/OFF Control

ON/OFF Function

By using ON/OFF function, the operation of this product can be disabled without disconnecting the input voltage. Sequencing of a power supply system and power-saving control can be easily implemented using this function.

(* Please note that an ON/OFF function for Vout3 does not exist)

ON/OFF Control Usage

When ON/OFF-pins(pin3,pin14) are left open or connected to GND The Output Voltage = OFF

When ON/OFF-pins(pin3,pin14) are connected to $\geq 2.5V$ The Output Voltage = ON

example

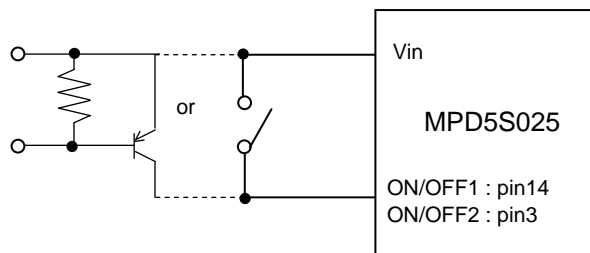

6-3. Input External Capacitor

External input capacitors are not necessary for the proper operation of this product.

But we recommend a capacitance of $\geq 20 \mu F$ be connected to the Vin terminal to minimize the possibility of any unstable operation that may be generated by input wiring impedance.

6-4. Output External Capacitors

External output capacitors are not necessary for the proper operation of this product.

However adding external capacitors may help to reduce output variations and ripple voltage.

In the event that output capacitance is implemented -

Output capacitance should be $\leq 47 \mu F$ when the ESR $\leq 50 m\Omega$.

Output capacitor should be $\leq 470 \mu F$ when the ESR $> 50 m\Omega$.

(Please note: Too much external capacitance may lead to the unstable operation of this product.)

⚠ Note:

1. This datasheet is downloaded from the website of Murata Manufacturing co., ltd. Therefore, it's specifications are subject to change or our products in it may be discontinued without advance notice. Please check with our sales representatives or product engineers before ordering.
2. This datasheet has only typical specifications because there is no space for detailed specifications. Therefore, please approve our product specifications or transact the approval sheet for product specifications before ordering.

7. Typical Electrical Characteristics Data

7-1. Static Load Regulation

($T_a=25^\circ\text{C}$, $V_{out1}=1.8\text{V}$, $V_{out2}=3.3\text{V}$, $V_{out3}=2.5\text{V}$, $I_{omax1}=1.6\text{A}$, $I_{omax2}=1.3\text{A}$, $I_{omax3}=0.3\text{A}$)

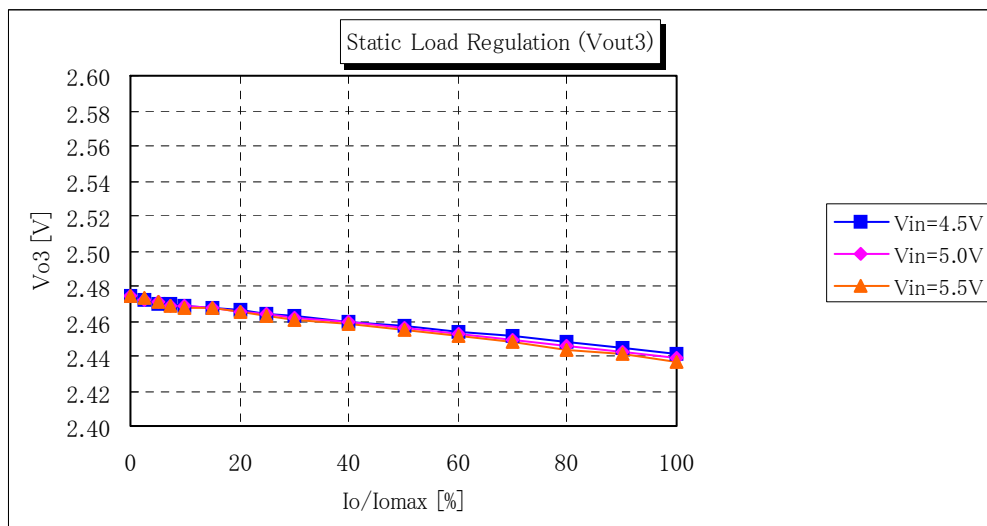
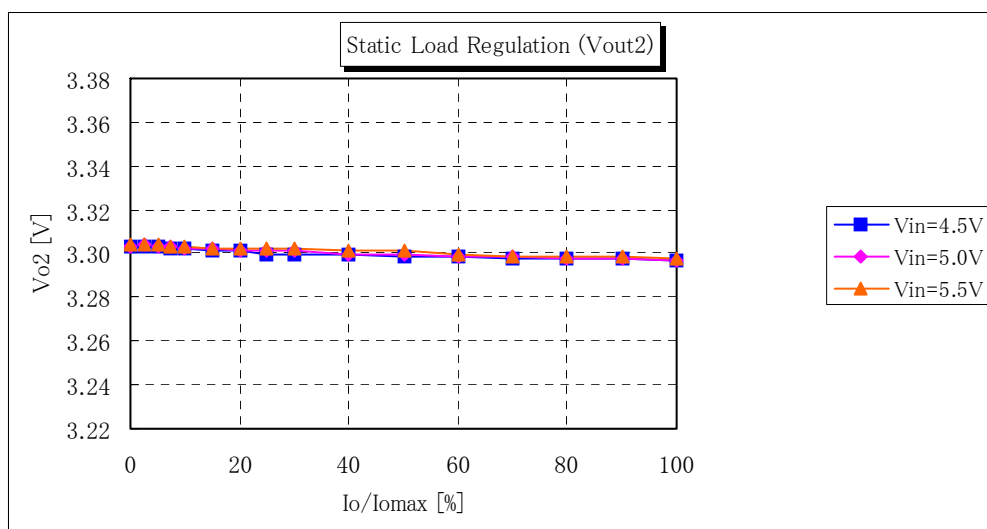
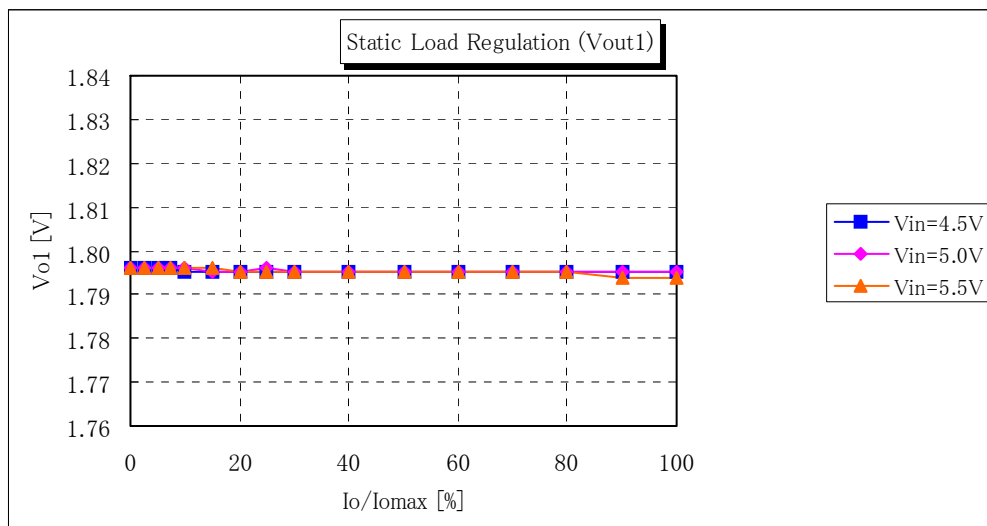

Note:

1. This datasheet is downloaded from the website of Murata Manufacturing co., Ltd. Therefore, it's specifications are subject to change or our products in it may be discontinued without advance notice. Please check with our sales representatives or product engineers before ordering.
2. This datasheet has only typical specifications because there is no space for detailed specifications. Therefore, please approve our product specifications or transact the approval sheet for product specifications before ordering.

7-2. Output Ripple Voltage

($T_a=25^\circ\text{C}$, $V_{out1}=1.8\text{V}$, $V_{out2}=3.3\text{V}$, $I_{omax1}=1.6\text{A}$, $I_{omax2}=1.3\text{A}$, $I_{omax3}=0.3\text{A}$, $C_{out}=1\mu\text{F}$, $\text{BW}=20\text{MHz}$)

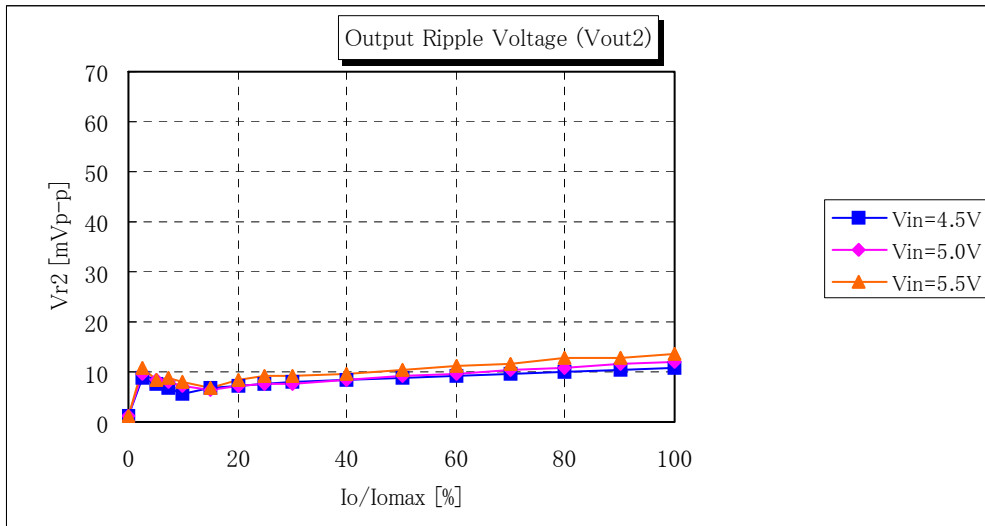
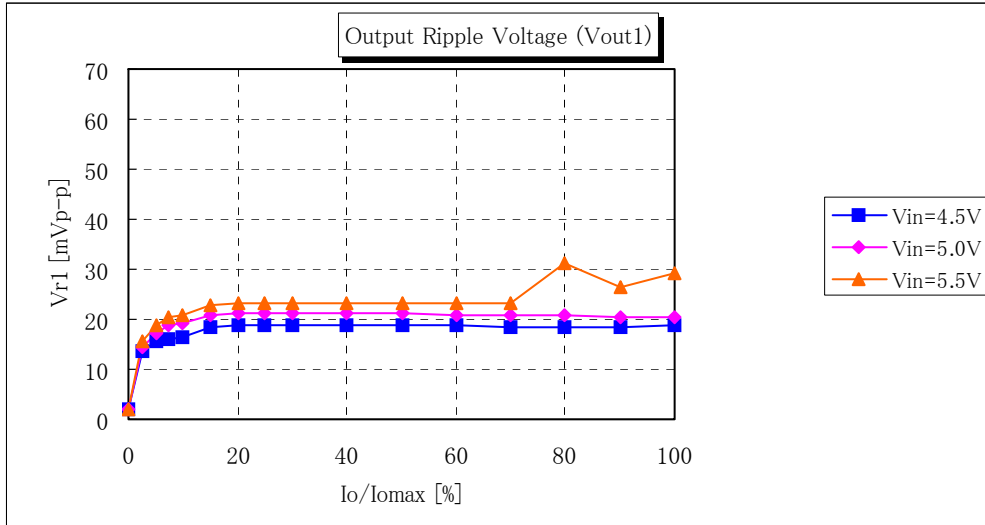

7-3. Efficiency

($T_a=25^\circ\text{C}$, $V_{out1}=1.8\text{V}$, $V_{out2}=3.3\text{V}$, $V_{out3}=2.5\text{V}$, $I_{omax1}=1.6\text{A}$, $I_{omax2}=1.3\text{A}$, $I_{omax3}=0.3\text{A}$)

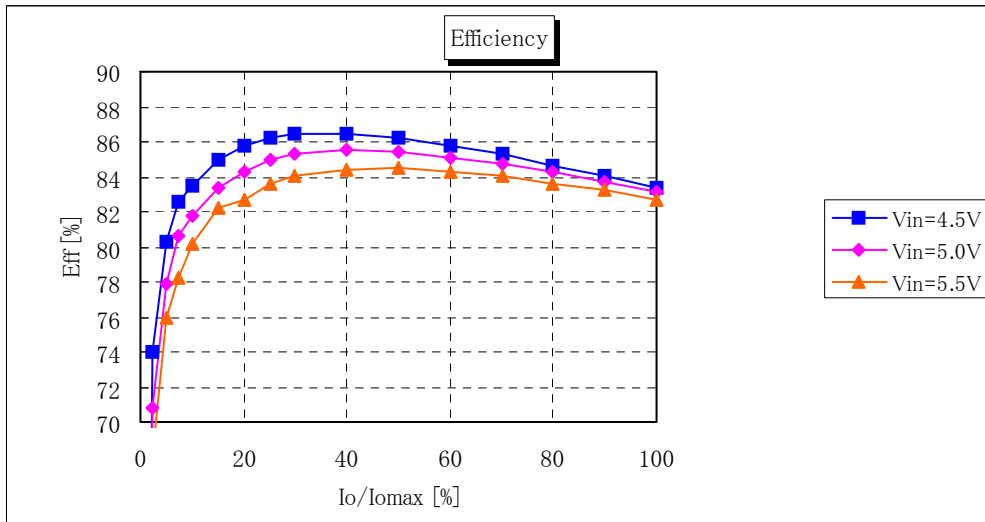

Note:

1. This datasheet is downloaded from the website of Murata Manufacturing co., ltd. Therefore, it's specifications are subject to change or our products in it may be discontinued without advance notice. Please check with our sales representatives or product engineers before ordering.
2. This datasheet has only typical specifications because there is no space for detailed specifications. Therefore, please approve our product specifications or transact the approval sheet for product specifications before ordering.

8. Mounting Conditions

8-1. Solder

8-1-1. Lead Free Solder

Please use the solder Sn-3Ag-0.5Cu.

8-1-2. Eutectic Solder

Please use the solder H60, H63 (in JIS Z 3282) or equivalent.

8-2. Recommended Soldering Conditions

8-2-1. Lead Free Solder

Please solder under the following conditions :

- Flow Soldering Preheating :120±10°C 60-120 seconds
 - Soldering : 260 °C±5 °C
 - Time :not more than 10seconds
 - Soldering Iron Condition :350°C MAX, 5 seconds at maximum
- (Soldering iron of less than 30W should be used.)

8-2-2. Eutectic Solder

Please solder under the following conditions :

- Flow Soldering Preheating :120±10°C 60~120 seconds
 - Soldering :230 °C +0°C /-5°C
 - Time :not more than 5 seconds
 - Soldering Iron Condition :300°C MAX, 3 seconds maximum
- Soldering iron of less than 30W should be used.

9. Notice

Input / Output Capacitance

- 1) Both on the input-side and the output-side please make the conductive loop between plus and minus terminals as small as possible. Doing this can minimize the influence of a leakage inductance.
- 2) Please make the power-line pattern as wide and short as possible.

This product should not be operated in parallel nor in series.

Using a connector or a socket to connect this product to your product is not recommended.

The electrical characteristics may be diminished by the influence of the contact resistance.

We recommend that appropriate fail-safe functions on your product be applied to prevent possible secondary damage that may be caused in the very unlikely event of malfunction or failure of this product.

In-rush current protection is not a feature of this product.

⚠ Note:

1. This datasheet is downloaded from the website of Murata Manufacturing co., ltd. Therefore, it's specifications are subject to change or our products in it may be discontinued without advance notice. Please check with our sales representatives or product engineers before ordering.
2. This datasheet has only typical specifications because there is no space for detailed specifications. Therefore, please approve our product specifications or transact the approval sheet for product specifications before ordering.

Please connect the input terminals with the correct polarity. If an error in connection polarity is made this product may be damaged. If this product is damaged internally, an elevated input current may flow, and so this product may exhibit an abnormal temperature rise, or your product may be damaged.

It is recommended that a diode and fuse (per the following diagram) be added for protection.

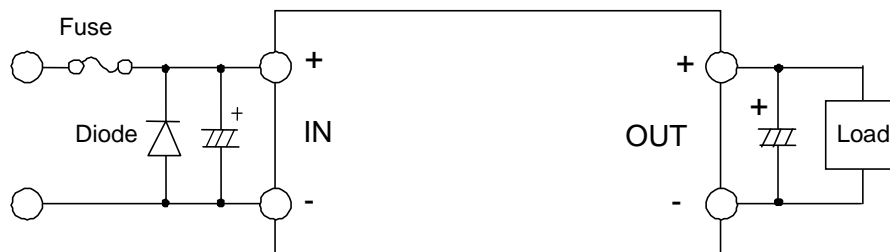

Fuse Current Rating Standard: 5A

Please select diode and fuse after confirming the operation of your product.

⚠ Note

1. Please contact our main sales office or nearby sales office before using our products for the applications listed below which require especially high reliability for the prevention of defects which might directly cause damage to the third party's life, body or property or this products for any other applications that described in the above.

- ① Aircraft equipment
- ② Aerospace equipment
- ③ Undersea equipment
- ④ Power plant control equipment
- ⑤ Medical equipment
- ⑥ Transportation equipment (vehicles, trains, ships, etc.)
- ⑦ Traffic signal equipment
- ⑧ Disaster prevention /crime prevention equipment
- ⑨ Application of similar complexity and/or reliability requirements to the applications listed in the above.

2. This application manual was issued Sep. 2006. The contents may be modified or obsoleted without prior notice.

To obtain the most updated documentation please contact our main sales office or nearby sales office.

⚠ Note:

1. This datasheet is downloaded from the website of Murata Manufacturing co., Ltd. Therefore, it's specifications are subject to change or our products in it may be discontinued without advance notice. Please check with our sales representatives or product engineers before ordering.
2. This datasheet has only typical specifications because there is no space for detailed specifications. Therefore, please approve our product specifications or transact the approval sheet for product specifications before ordering.