

## Excellent Integrated System Limited

Stocking Distributor

Click to view price, real time Inventory, Delivery & Lifecycle Information:

[Maxim Integrated](#)  
[MAX1298CEAE+](#)

For any questions, you can email us directly:

[sales@integrated-circuit.com](mailto:sales@integrated-circuit.com)

19-1726; Rev 1; 3/12



# 12-Bit Serial-Output Temperature Sensors with 5-Channel ADC

**MAX1298/MAX1299**

## General Description

The MAX1298/MAX1299 implement local and remote temperature sensing with 12-bit resolution, using +5V and +3V supply voltages, respectively. Accuracy is  $\pm 1^\circ\text{C}$  from 0 to  $+70^\circ\text{C}$ , with no calibration needed. The devices feature an algorithmic switched-capacitor analog-to-digital converter (ADC), an on-chip clock, and a 3-wire serial interface compatible with SPI, QSPI™, and MICROWIRE®.

The MAX1298/MAX1299 also perform fully differential voltage measurements with 12-bit resolution and separate track-and-hold (T/H) for positive and negative inputs. Both devices accept versatile input modes consisting of two 3-channel signal pairs, five 1-channel signals relative to an AIN5, or  $V_{DD}/4$  relative to ground. An external reference may be used for more accurate voltage measurements.

Typical power consumption is only 1.3mW (MAX1299). A shutdown mode and two standby modes provide multiple strategies for prolonging battery life in portable applications that require limited sampling throughput.

The MAX1298/MAX1299 are available in 16-pin SSOP packages.

## Applications

- Temperature/Voltage Supervision of Workstations and Communications Equipment
- Hand-Held Instruments
- Medical Equipment
- Industrial Process Control

Typical Operating Circuit appears at end of data sheet.

QSPI is a trademark of Motorola, Inc.  
 MICROWIRE is a registered trademark of National Semiconductor Corp.



Maxim Integrated Products 1

For pricing, delivery, and ordering information, please contact Maxim Direct at 1-888-629-4642, or visit Maxim's website at [www.maxim-ic.com](http://www.maxim-ic.com).

## Features

- ◆ Local and Remote Temperature Sensing
- ◆ 12-Bit Resolution for Temperature and Voltage Inputs
- ◆  $\pm 1^\circ\text{C}$  Accuracy from  $-40^\circ\text{C}$  to  $+85^\circ\text{C}$
- ◆ Fully Differential Inputs
- ◆ Single-Supply Operation
  - +4.75V to +5.25V (MAX1298)
  - +2.7V to +3.6V (MAX1299)
- ◆ 3-Wire SPI/QSPI/MICROWIRE-Compatible Interface
- ◆ Internal Precision Voltage Reference
  - 2.50V (MAX1298)
  - 1.20V (MAX1299)
- ◆ Space-Saving 16-Pin SSOP Package

## Ordering Information

PART	TEMP RANGE	PIN-PACKAGE
MAX1298CEAE+	$-40^\circ\text{C}$ to $+85^\circ\text{C}$	16 SSOP
MAX1299CEAE+	$-40^\circ\text{C}$ to $+85^\circ\text{C}$	16 SSOP

+Denotes a lead(Pb)-free/RoHS-compliant package.

## Pin Configuration

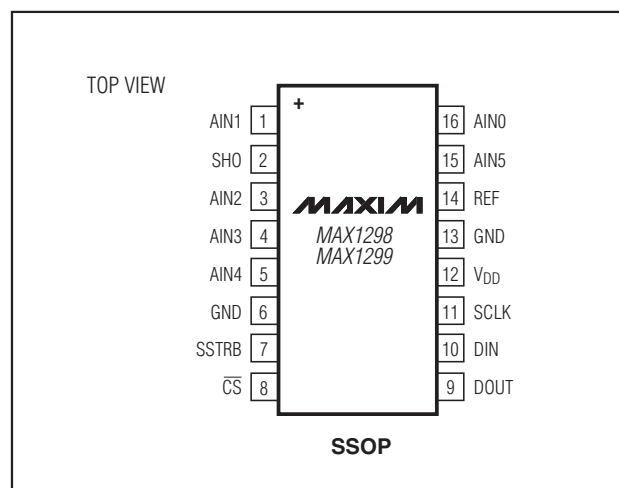

# 12-Bit Serial-Output Temperature Sensors with 5-Channel ADC

MAX1298/MAX1299

## ABSOLUTE MAXIMUM RATINGS

V <sub>DD</sub> to GND.....	-0.3V to +6V	Maximum Current into Any Pin.....	50mA
SHO to GND.....	-0.3V to (V <sub>DD</sub> + 0.3V)	Continuous Power Dissipation (T <sub>A</sub> = +70°C)	
Analog Inputs to GND		16-Pin SSOP (derate 7.1mW/°C above +70°C) .....	571.4mW
(AIN0, AIN1, AIN2, AIN3, AIN4,		Operating Temperature Range .....	-40°C to +85°C
AIN5, REF).....	-0.3V to (V <sub>DD</sub> + 0.3V)	Junction Temperature.....	+150°C
Digital Inputs to GND (DIN, SCLK, CS).....	-0.3V to (V <sub>DD</sub> + 0.3V)	Storage Temperature Range .....	-65°C to +150°C
Digital Outputs to GND (DOUT, SSTRB).....	-0.3V to (V <sub>DD</sub> + 0.3V)	Lead Temperature (soldering, 10s) .....	+300°C
Digital Output Sink Current .....	25mA	Soldering Temperature (reflow) .....	+260°C

Stresses beyond those listed under "Absolute Maximum Ratings" may cause permanent damage to the device. These are stress ratings only, and functional operation of the device at these or any other conditions beyond those indicated in the operational sections of the specifications is not implied. Exposure to absolute maximum rating conditions for extended periods may affect device reliability.

## ELECTRICAL CHARACTERISTICS

(V<sub>DD</sub> = 4.75V to 5.25V (MAX1298), V<sub>DD</sub> = +2.7V to 3.6V (MAX1299), external reference, V<sub>REF</sub> = +2.5V (MAX1298), V<sub>REF</sub> = +1.2V (MAX1299), f<sub>SCLK</sub> = 2.5MHz, T<sub>A</sub> = T<sub>MIN</sub> to T<sub>MAX</sub>, unless otherwise noted. Typical values are at T<sub>A</sub> = +25°C.)

PARAMETER	SYMBOL	CONDITIONS	MIN	TYP	MAX	UNITS
<b>DC ACCURACY</b> (Note 1)						
Resolution	RES		12			Bits
Relative Accuracy (Note 2)	INL				±1	LSB
Differential Nonlinearity	DNL				±1	LSB
Offset Error		Inputs AIN0–AIN5			±2	LSB
Offset Temperature Coefficient				±10		µV/°C
Gain Error		Inputs AIN0–AIN5, offset nulled			±4	LSB
V <sub>DD</sub> /4 Absolute Error					±2	LSB
Gain Temperature Coefficient				±2		ppm/°C
Channel-to-Channel Offset Matching				±0.5		LSB
<b>CONVERSION RATE</b>						
Conversion Time (Note 3)	t <sub>CONV</sub>	Voltage measurement			1.1	ms
		Temperature measurement			2.2	
Track/Hold Acquisition Time	t <sub>ACQ</sub>			16		µs
Aperture Delay	t <sub>APR</sub>			30		ns
Internal Clock Frequency	f <sub>CLK</sub>		57.6	62.3	65.5	kHz
<b>ANALOG INPUTS</b> (AIN0–AIN5)						
Input Voltage Range (Note 4)		Measurement with respect to IN-, Figure 1	-2V <sub>REF</sub>		+2V <sub>REF</sub>	V
Common-Mode Range			0		V <sub>DD</sub>	V
Input Current (Note 5)				0.1	5	µA
Input Capacitance				16		pF

# 12-Bit Serial-Output Temperature Sensors with 5-Channel ADC

MAX1298/MAX1299

## ELECTRICAL CHARACTERISTICS (continued)

(V<sub>DD</sub> = 4.75V to 5.25V (MAX1298), V<sub>DD</sub> = +2.7V to 3.6V (MAX1299), external reference, V<sub>REF</sub> = +2.5V (MAX1298), V<sub>REF</sub> = +1.2V (MAX1299), f<sub>SCLK</sub> = 2.5MHz, T<sub>A</sub> = T<sub>MIN</sub> to T<sub>MAX</sub>, unless otherwise noted. Typical values are at T<sub>A</sub> = +25°C.)

PARAMETER	SYMBOL	CONDITIONS	MIN	TYP	MAX	UNITS	
<b>DIGITAL INPUTS</b>							
Input Voltage Low	V <sub>IL</sub>				0.8	V	
Input Voltage High	V <sub>IH</sub>		V <sub>DD</sub> - 0.8			V	
Input Hysteresis	V <sub>HYST</sub>			0.2		V	
Input Leakage Current	I <sub>IN</sub>				1	μA	
Input Capacitance				16		pF	
<b>DIGITAL OUTPUTS</b>							
Output Low Voltage	V <sub>OL</sub>	I <sub>SINK</sub> = 5mA			0.6	V	
Output High Voltage	V <sub>OH</sub>	I <sub>SOURCE</sub> = 0.5mA	V <sub>DD</sub> - 0.6			V	
Three-State Output Leakage Current	I <sub>OUT</sub>				±10	μA	
Three-State Output Capacitance				15		pF	
<b>POWER REQUIREMENTS</b>							
Positive Supply Voltage	V <sub>DD</sub>	MAX1298	4.75		5.25	V	
		MAX1299	2.7		3.6		
Positive Supply Current (Note 6)	I <sub>DD</sub>	Full-on, voltage measurements, internal reference	MAX1298	390		μA	
			MAX1299	350			
		Full-on, voltage measurements, external reference	MAX1298	310			
			MAX1299	280			
		Full-on, temperature measurements, internal reference	MAX1298	440	500		
			MAX1299	400	500		
		Full-on, temperature measurements, external reference	MAX1298	360			
			MAX1299	330			
Standby, SCLK = GND		120					
Standby-plus, SCLK = GND		190					
Shutdown, SCLK = GND		2	10				
Power-Supply Rejection Ratio	PSRR	(Note 7)	50	65		dB	
<b>INTERNAL VOLTAGE REFERENCE CHARACTERISTICS</b>							
Reference Voltage	V <sub>REF</sub>	V <sub>DD</sub> = 5V	MAX1298	2.494	2.50	2.506	V
		V <sub>DD</sub> = 3V	MAX1299	1.197	1.20	1.203	
Reference Tempco	TC V <sub>REF</sub>			±20		ppm/°C	
Output Short-Circuit Current					1.25	mA	
Capacitive Bypass at REF			0.1			μF	
REF Output Noise		f <sub>N</sub> = 10Hz to 10kHz	MAX1298	130		μV <sub>RMS</sub>	
			MAX1299	65			

# 12-Bit Serial-Output Temperature Sensors with 5-Channel ADC

MAX1298/MAX1299

## ELECTRICAL CHARACTERISTICS (continued)

(V<sub>DD</sub> = 4.75V to 5.25V (MAX1298), V<sub>DD</sub> = +2.7V to 3.6V (MAX1299), external reference, V<sub>REF</sub> = +2.5V (MAX1298), V<sub>REF</sub> = +1.2V (MAX1299), f<sub>SCLK</sub> = 2.5MHz, T<sub>A</sub> = T<sub>MIN</sub> to T<sub>MAX</sub>, unless otherwise noted. Typical values are at T<sub>A</sub> = +25°C.)

PARAMETER	SYMBOL	CONDITIONS	MIN	TYP	MAX	UNITS
REF Line Regulation			MAX1298	+3.0		mV/V
			MAX1299	+0.2		
REF Load Regulation		0 to 100μA output current (Note 8)	MAX1298	4	10	μV/μA
			MAX1299	2	10	
<b>EXTERNAL VOLTAGE REFERENCE CHARACTERISTICS</b>						
Reference Voltage Range	V <sub>REF</sub>	MAX1298	0.8		2.5	V
		MAX1299	0.8		1.2	
REF Input Resistance		Converting		10		MΩ
		Shutdown		25		
REF Input Capacitance				24		pF
<b>INTERNAL TEMPERATURE MEASUREMENT CHARACTERISTICS</b>						
Resolution				0.13		°C
Output Error (Notes 1, 9)		T <sub>A</sub> = +85°C, P <sub>D</sub> = 1mW	MAX129_C		±1	°C
		T <sub>A</sub> = 0°C to +70°C	MAX129_C		±2	
		T <sub>A</sub> = -40°C to 0°C, T <sub>A</sub> = +70°C to +85°C	MAX129_C		±4	
Power-Supply Rejection Ratio	PSRR	(Note 7)		0.2		°C/V
Noise				0.18		°C <sub>RMS</sub>
<b>EXTERNAL TEMPERATURE MEASUREMENT CHARACTERISTICS</b>						
Output Error		2N3904 (Note 10)		±2	±4	°C
Remote Diode Excitation (1X)				10		μA
Remote Diode Excitation (10X)				100		μA

# 12-Bit Serial-Output Temperature Sensors with 5-Channel ADC

MAX1298/MAX1299

## TIMING CHARACTERISTICS

( $V_{DD} = +4.75V$  to  $5.25V$  (MAX1298),  $V_{DD} = +2.7V$  to  $+3.6V$  (MAX1299), external reference,  $V_{REF} = +2.5V$  (MAX1298),  $V_{REF} = +1.2V$  (MAX1299),  $f_{SCLK} = 2.5MHz$ ,  $T_A = T_{MIN}$  to  $T_{MAX}$ , unless otherwise noted. Typical values are at  $T_A = +25^{\circ}C$ .) (Figures 4, 6)

PARAMETER	SYMBOL	CONDITIONS	MIN	TYP	MAX	UNITS
SCLK Frequency	$f_{SCLK}$				2.5	MHz
SCLK Pulse Width Low	$t_{CL}$		200			ns
SCLK Pulse Width High	$t_{CH}$		200			ns
$\overline{CS}$ Low to SCLK High	$t_{CSS}$		100			ns
SCLK High to $\overline{CS}$ Setup	$t_{CSH}$		100			ns
$\overline{CS}$ Pulse Width	$t_{CS}$		100			ns
SCLK High to $\overline{CS}$ Low Setup	$t_{CS0}$		50			ns
SCLK High to $\overline{CS}$ High Setup	$t_{CS1}$		100			ns
DIN Setup to SCLK High Time	$t_{DS}$		100			ns
DIN Hold Time	$t_{DH}$		0			ns
SCLK Fall to Output Data Valid	$t_{DO}$	$R_L = 100k\Omega$ , $C_L = 50pF$			150	ns
$\overline{CS}$ Fall to Output Enable	$t_{DV}$	$R_L = 100k\Omega$ , $C_L = 50pF$			150	ns
$\overline{CS}$ Rise to Output Disable	$t_{TR}$	$R_L = 100k\Omega$ , $C_L = 50pF$			50	ns
SSTRB Rise to SCLK Rise	$t_{SCLK}$		0			ns
SCLK Fall to SSTRB Fall	$t_{SSTRB}$				200	ns

**Note 1:** Tested at  $V_{DD} = +5.0V$  (MAX1298) and  $V_{DD} = +3.0V$  (MAX1299).

**Note 2:** Relative accuracy is the deviation of the analog value at any code from its theoretical value after the full-scale range has been calibrated.

**Note 3:** Conversion time is defined as the number of clock cycles (64 for voltage measurements, 125 for temperature measurements) multiplied by the internal clock period.

**Note 4:** Individual analog input voltages cannot extend beyond the power-supply rails.

**Note 5:** Input resistance is typically  $250M\Omega$ ;  $5\mu A$  limit reflects limitations in production testing.

**Note 6:** Specifications for full-on status assume continuous conversions. Power modes are software selected (Table 4).

**Note 7:** Measured at  $V_{FS(+4.75V)} - V_{FS(+5.25V)}$  for the MAX1298 and at  $V_{FS(+2.7V)} - V_{FS(+3.6V)}$  for the MAX1299.

**Note 8:** External load should not change during conversions for specified accuracy.

**Note 9:** Excludes noise and self-heating effects. Output error for MAX129\_C guaranteed by design.

**Note 10:** External temperature sensing over  $-40^{\circ}C$  to  $+85^{\circ}C$  range, device at  $+25^{\circ}C$ . Guaranteed by design.

# 12-Bit Serial-Output Temperature Sensors with 5-Channel ADC

## Typical Operating Characteristics

( $T_A = +25^\circ\text{C}$ , unless otherwise noted.)

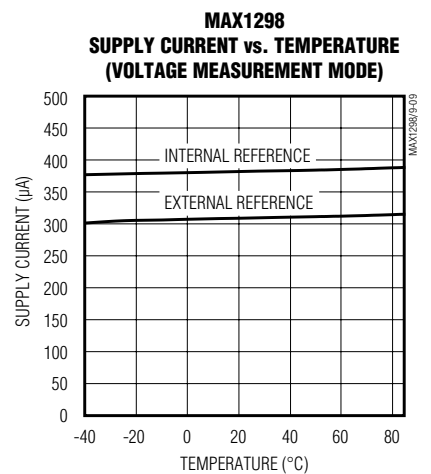
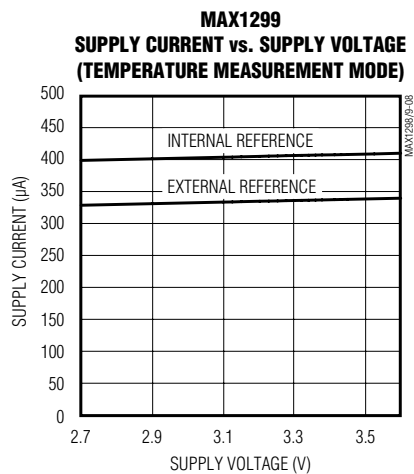
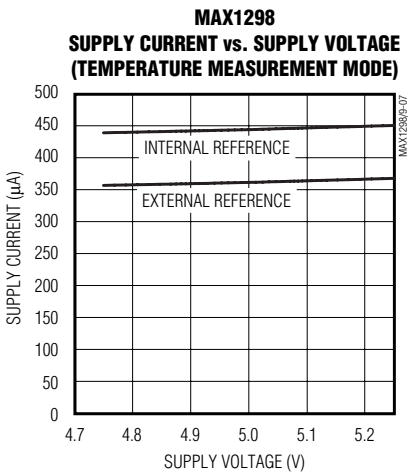
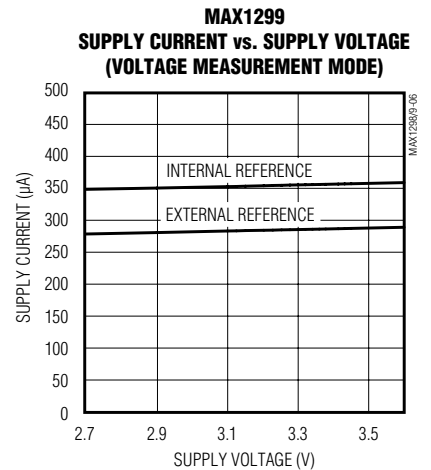
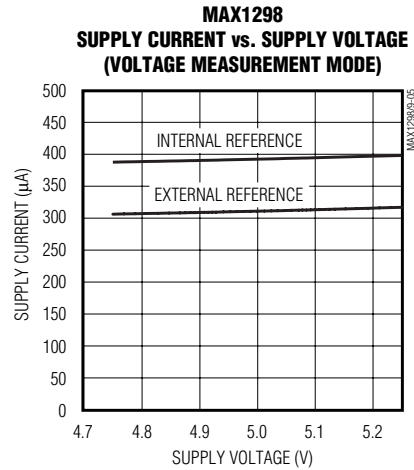
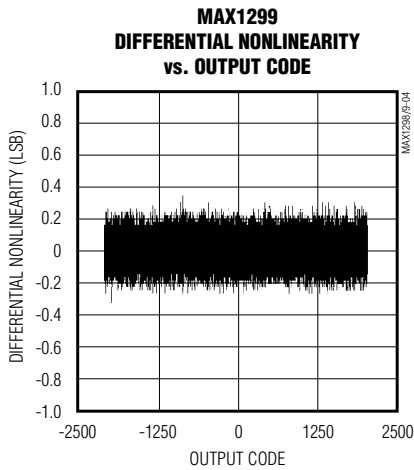
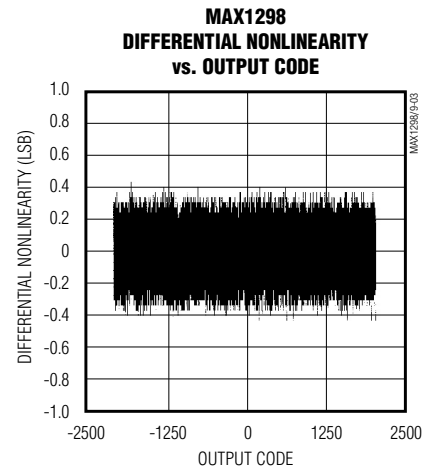
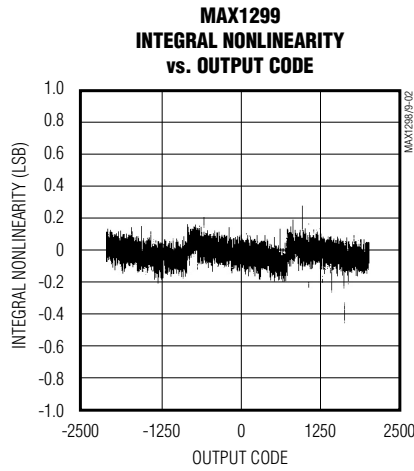
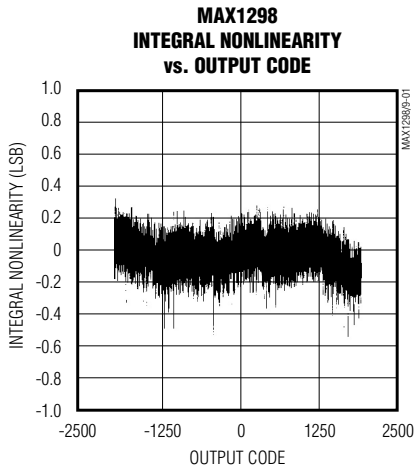

# 12-Bit Serial-Output Temperature Sensors with 5-Channel ADC

## Typical Operating Characteristics (continued)

(T<sub>A</sub> = +25°C, unless otherwise noted.)

**MAX1298/MAX1299**

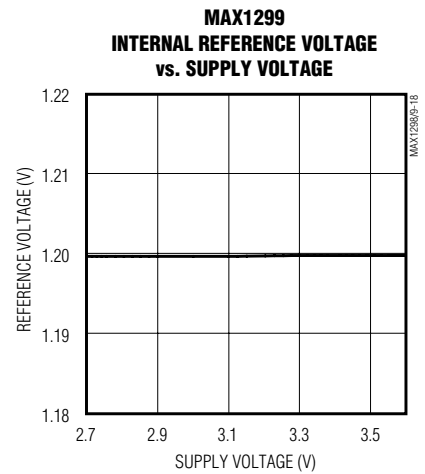
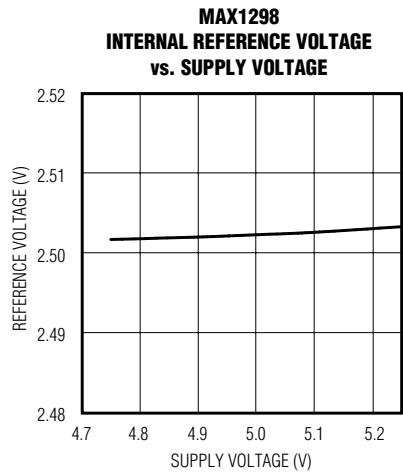
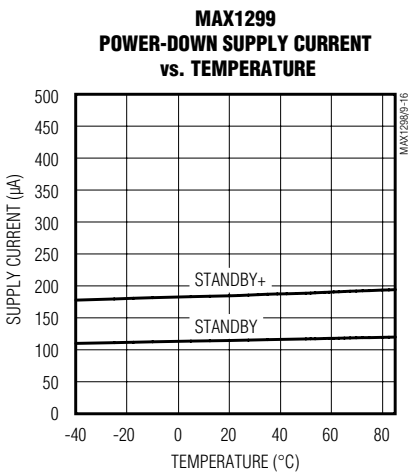
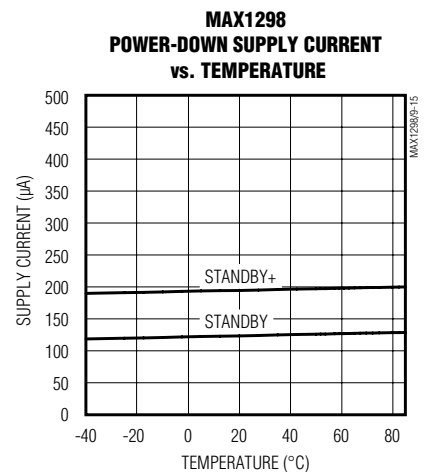
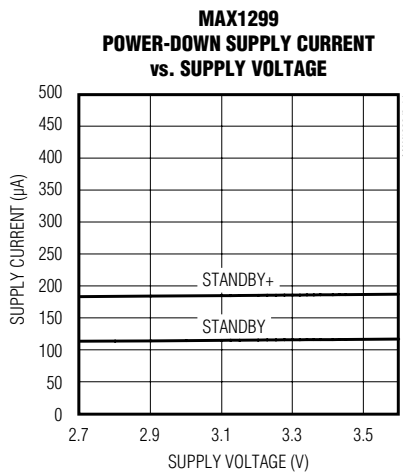
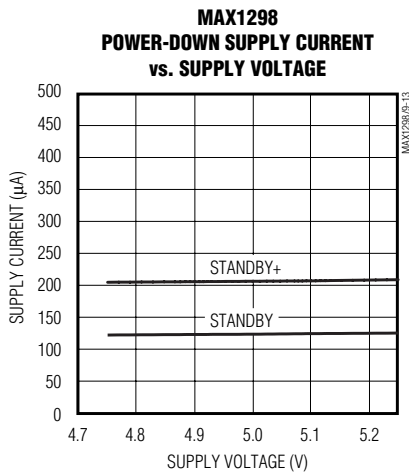
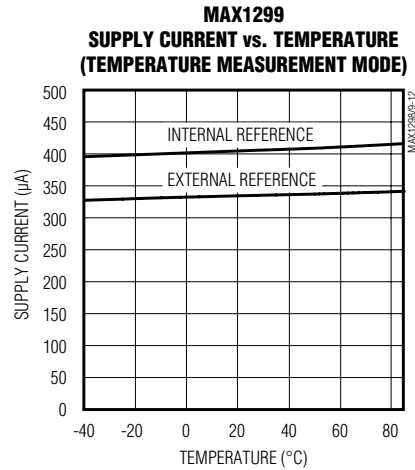
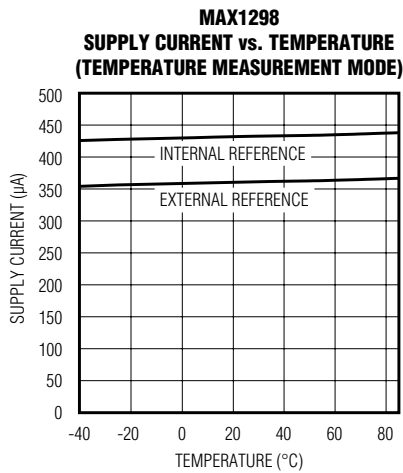
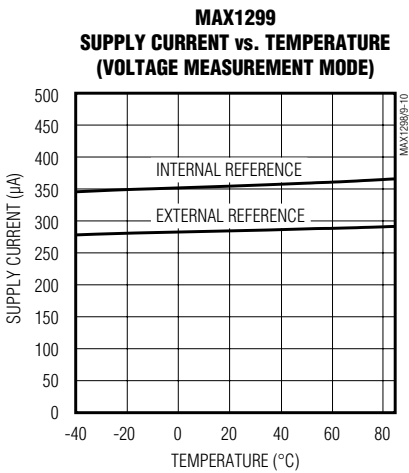



# 12-Bit Serial-Output Temperature Sensors with 5-Channel ADC

## Typical Operating Characteristics (continued)

(T<sub>A</sub> = +25°C, unless otherwise noted.)

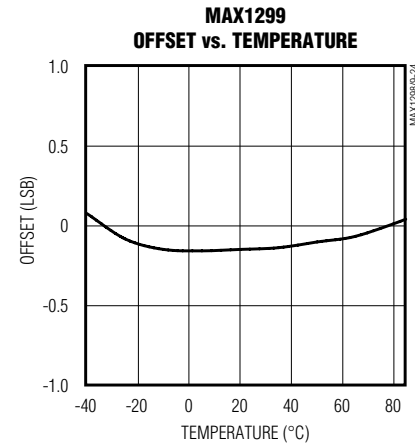
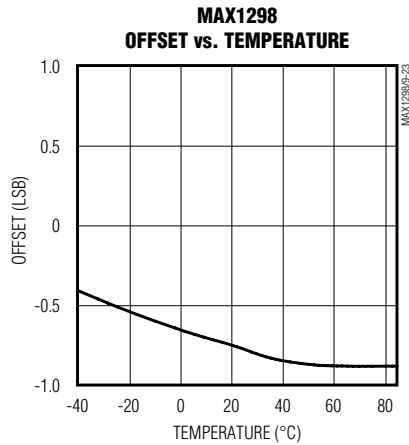
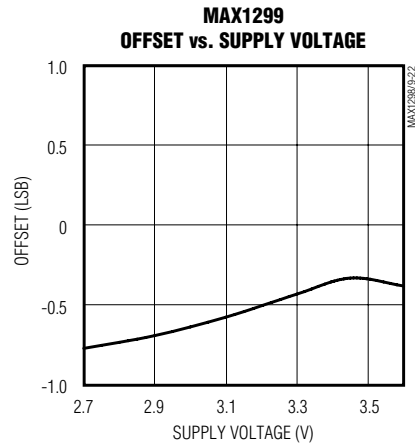
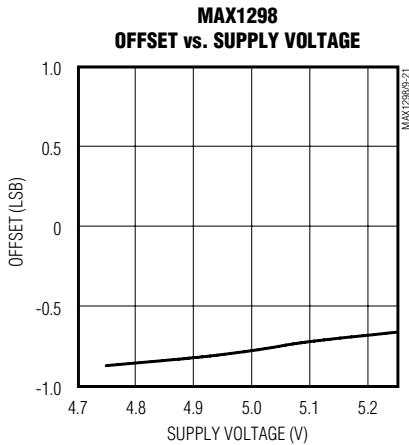
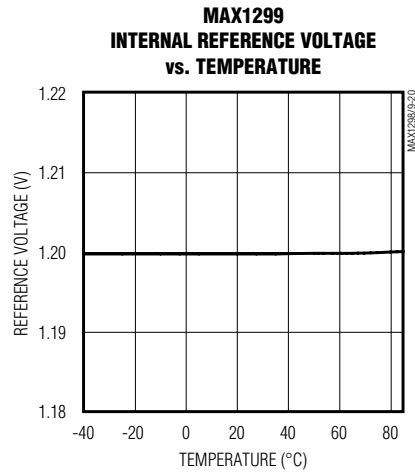
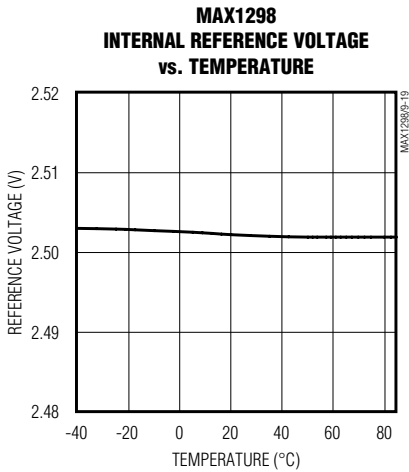

# 12-Bit Serial-Output Temperature Sensors with 5-Channel ADC

## Typical Operating Characteristics (continued)

(T<sub>A</sub> = +25°C, unless otherwise noted.)

**MAX1298/MAX1299**

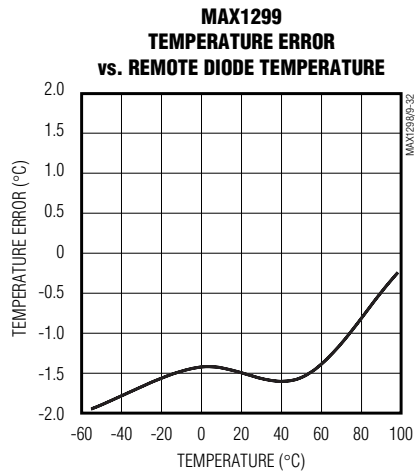
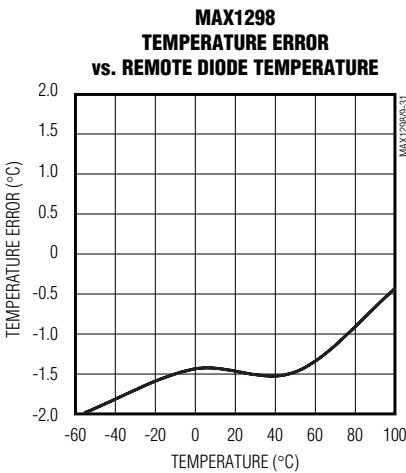
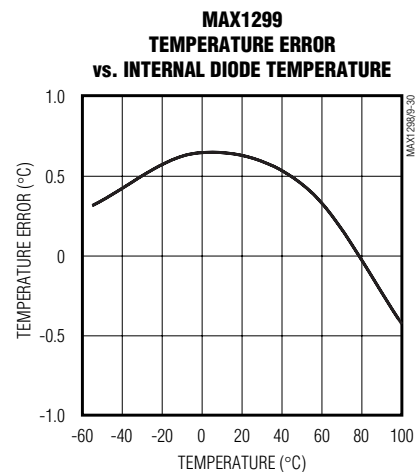
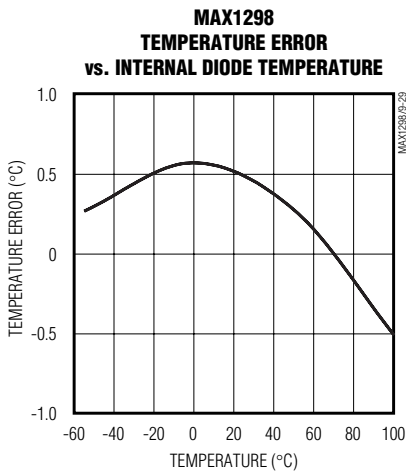
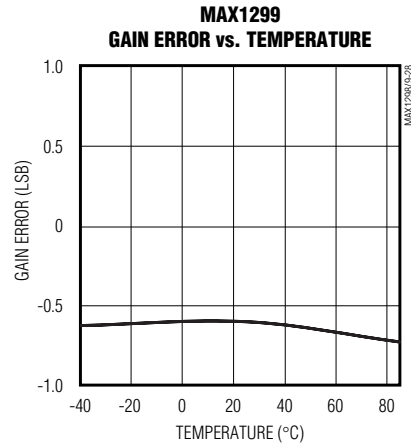
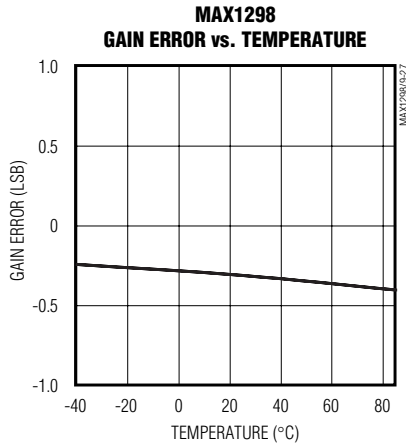

# 12-Bit Serial-Output Temperature Sensors with 5-Channel ADC

## Pin Description

MAX1298/MAX1299

PIN	NAME	FUNCTION
1	AIN1	Analog Input 1. Negative differential input relative to AIN0 or positive differential input relative to AIN5 (Table 5). Connect to the cathode of external diode 1 for remote temperature sensing.
2	SHO	Shield Output. Used to suppress leakage currents at the anodes of remote temperature sensors (see <i>Remote Diode Shielding</i> ). May also be connected to the shield of twisted-pair input cables used for remote temperature measurements. Leave unconnected for other applications.
3	AIN2	Analog Input 2. Positive differential input relative to AIN3 or positive differential input relative to AIN5 (Table 5). Connect to the anode of external diode 2 for remote temperature sensing.
4	AIN3	Analog Input 3. Negative differential input relative to AIN2 or positive differential input relative to AIN5 (Table 5). Connect to the cathode of external diode 2 for remote temperature sensing.
5	AIN4	Analog input 4. Positive differential input relative to AIN5 (Table 5).
6	GND	Ground. Connect to pin 13.
7	SSTRB	Serial Strobe Output. SSTRB goes low at the beginning of an A/D conversion, and it goes high when the conversion is finished.
8	$\overline{CS}$	Active-Low Chip Select. Data will not be clocked into DIN unless $\overline{CS}$ is low. When $\overline{CS}$ is high, DOUT is at high impedance.
9	DOUT	Serial Data Output. DOUT transitions on the falling edge of SCLK.
10	DIN	Serial Data Input. DIN latches data on the rising edge of SCLK.
11	SCLK	Serial Clock Input. Clocks data in and out of the serial interface.
12	V <sub>DD</sub>	Positive Supply Voltage. Bypass with a 0.1μF capacitor to GND (pin 13).
13	GND	Ground (star ground)
14	REF	Reference-Buffer Output/ADC Reference Input. Reference voltage for A/D conversion. Bypass to GND (pin 13) with a 0.1μF capacitor. Select reference mode by writing to configuration byte (Table 2).
15	AIN5	Analog Input 5. Negative differential input relative to AIN0–AIN4 (Table 5).
16	AIN0	Analog Input 0. Positive differential input relative to AIN1 or positive differential input relative to AIN5 (Table 5). Connect to the anode of external diode 1 for remote temperature sensing.

# 12-Bit Serial-Output Temperature Sensors with 5-Channel ADC

**MAX1298/MAX1299**

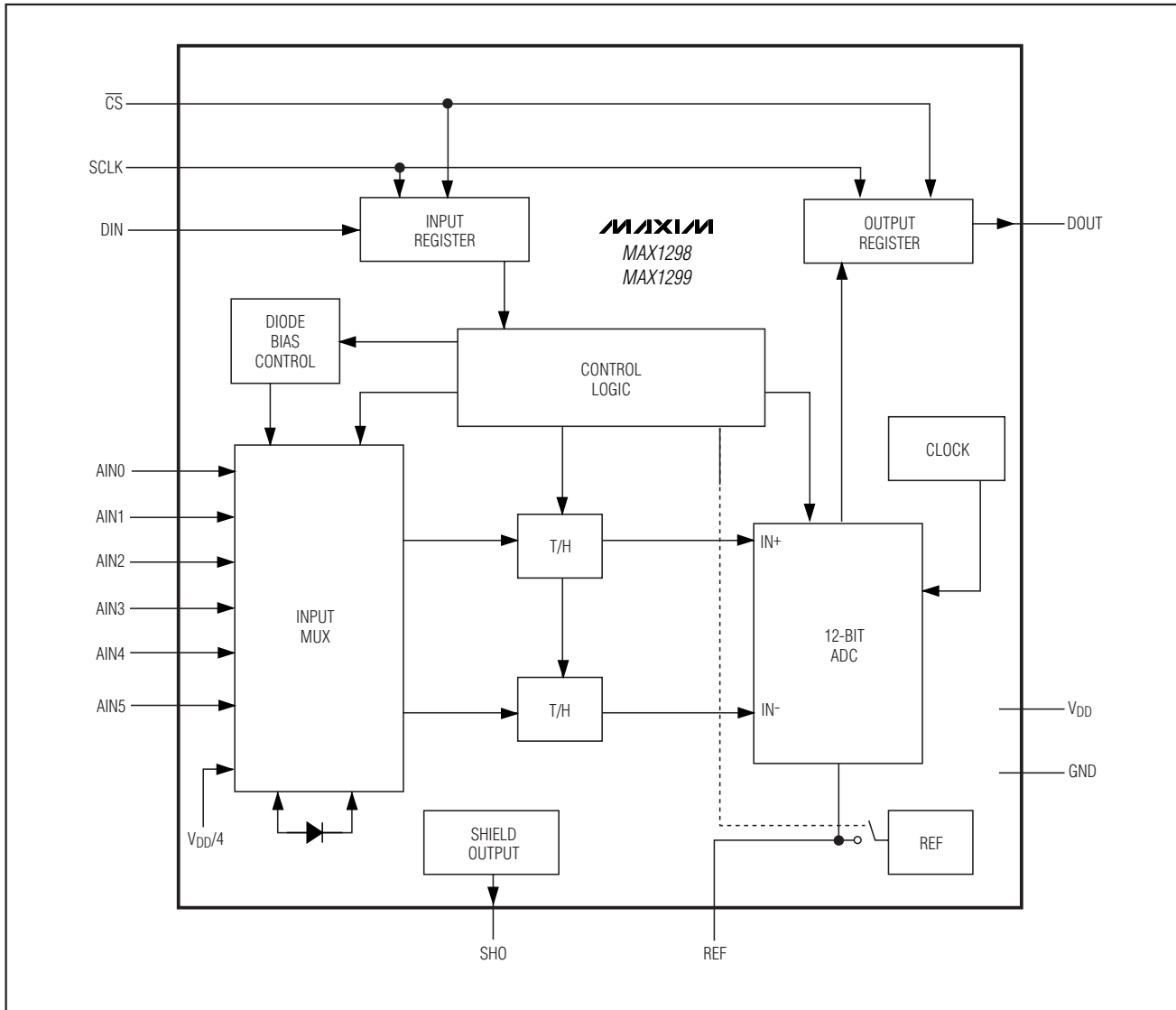

Figure 1. Functional Diagram

## Detailed Description

The MAX1298/MAX1299 are low-power, serial-output, multichannel ADCs with temperature-sensing capability for thermostatic, process-control, and monitoring applications. An algorithmic switched-capacitor converter with T/H circuitry for both positive and negative inputs supports fully differential 12-bit conversions from an internal temperature sensor, two external temperature sensors, or voltage sources in a variety of channel configurations.

Microprocessor ( $\mu$ P) control is made easy through a flexible 3-wire serial interface.

Figure 1 shows a simplified functional diagram of the internal architecture for the MAX1298/MAX1299. In temperature-sensing mode, the multiplexer (mux) steers bias currents through internal or external diodes while the ADC computes their temperature in relation to changes in forward voltage. Channels not used for temperature measurement can be configured to measure other system voltages.

## 12-Bit Serial-Output Temperature Sensors with 5-Channel ADC

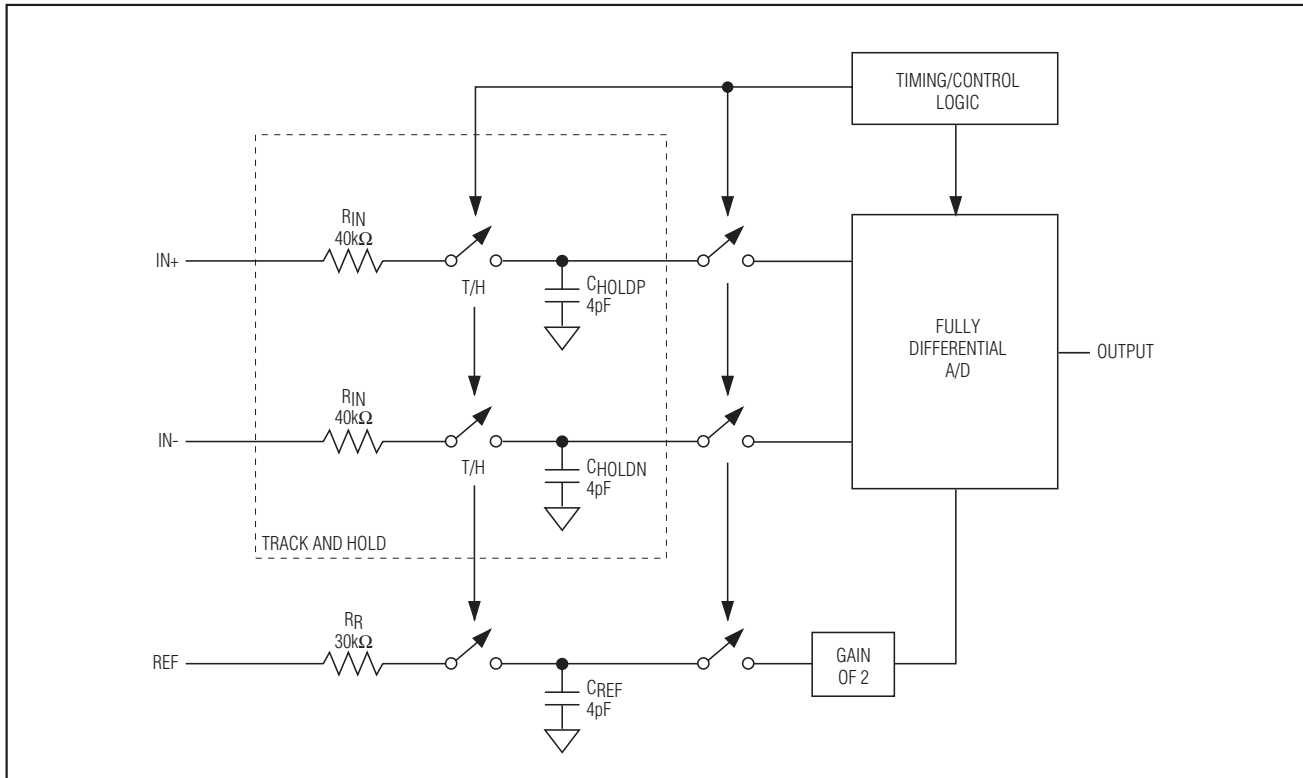

Figure 2. Converter Input Structure

### Converter Operation

Figure 2 shows a simplified model of the converter input structure. Once initiated, a voltage conversion requires 64  $f_{CLK}$  periods, where  $f_{CLK}$  is the internal master clock. Each conversion is preceded by 13  $f_{CLK}$  periods of warm-up time, performed in twelve 4  $f_{CLK}$  period cycles, and followed by 3  $f_{CLK}$  periods to load the output register.  $SSTRB$  falls at the beginning of a conversion and rises at the end of a conversion.

Inputs  $IN+$  and  $IN-$  charge capacitors  $CHOLDP$  and  $CHOLDN$ , respectively, during the acquisition interval that occurs during the first  $f_{CLK}$  period of the first conversion cycle. In the second  $f_{CLK}$  period, the T/H switches open so that charge is retained on  $CHOLDP$  and  $CHOLDN$  as a sample of the differential voltage between  $IN+$  and  $IN-$ . This charge is transferred to the ADC during the third and fourth  $f_{CLK}$  periods.

The reference sampling process begins in the second conversion cycle and continues until the conversion is complete. Sampling occurs during the second and

fourth  $f_{CLK}$  periods to yield an effective doubling of the reference voltage. The reference sampling requirement is signal dependent and may or may not occur in every subsequent conversion cycle.

Temperature conversion is essentially nothing more than subtracting the results of two sequential voltage conversions. The only difference is that output registers are not loaded at the end of the first conversion. Thus, temperature conversions require  $2 \times 64 - 3 = 125$   $f_{CLK}$  periods. Figures 3a and 3b show timing diagrams for voltage and temperature conversions, respectively.

### Track/Hold

The T/H stage for the MAX1298/MAX1299 is a simple switched-capacitor sampling operation. The time required for the T/H stage to acquire an input signal is a function of how fast its input capacitance is charged. If the signal source impedance is high, the acquisition time lengthens and more time must be allowed between conversions. The acquisition time ( $t_{ACQ}$ ) is the

## 12-Bit Serial-Output Temperature Sensors with 5-Channel ADC

**MAX1298/MAX1299**

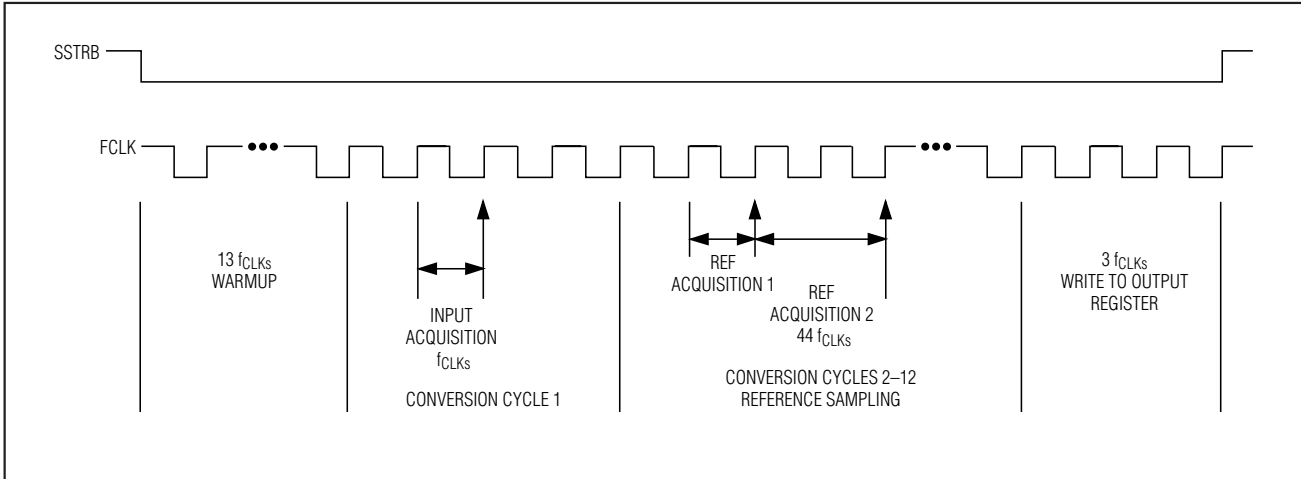

Figure 3a. Voltage Conversion Timing Diagram

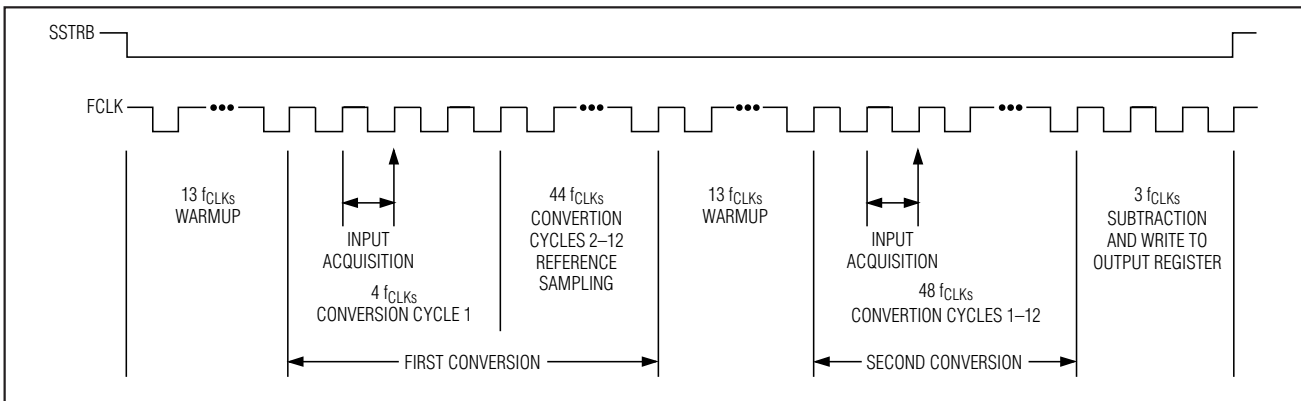

Figure 3b. Temperature Conversion Timing Diagram

maximum time the device takes to acquire the signal. Calculate this with the following equation:

$$t_{ACQ} = 7 (R_S + R_{IN}) C_{IN}$$

where  $R_S$  is the source impedance of the input signal,  $R_{IN}$  is the T/H input impedance (40k $\Omega$ ), and  $C_{IN}$  is the input sampling capacitance of the ADC (4pF). Source impedances below 100k $\Omega$  have no significant effect on MAX1298/MAX1299 AC performance.

### Analog Input Protection

Internal protection diodes clamp the analog inputs to  $V_{DD}$  and GND, so channels can swing within GND - 0.3V and  $V_{DD} + 0.3V$  without damage. However, for accurate conversions, the inputs should not extend beyond the supply rails.

**If an off-channel analog input extends beyond the supply rails, limit the input current to 2mA.**

### Serial Digital Interface

The MAX1298/MAX1299 feature a serial interface that is fully compatible with SPI, QSPI, and MICROWIRE devices. For SPI/QSPI, ensure that the CPU serial interface runs in master mode so it generates the serial clock signal. Select a 2.5MHz clock frequency or less, and set zero values for clock polarity (CPOL) and phase (CPHA) in the  $\mu P$  control registers. Figure 4 shows detailed serial interface timing information. See Tables 2-5 for programming information.

# 12-Bit Serial-Output Temperature Sensors with 5-Channel ADC

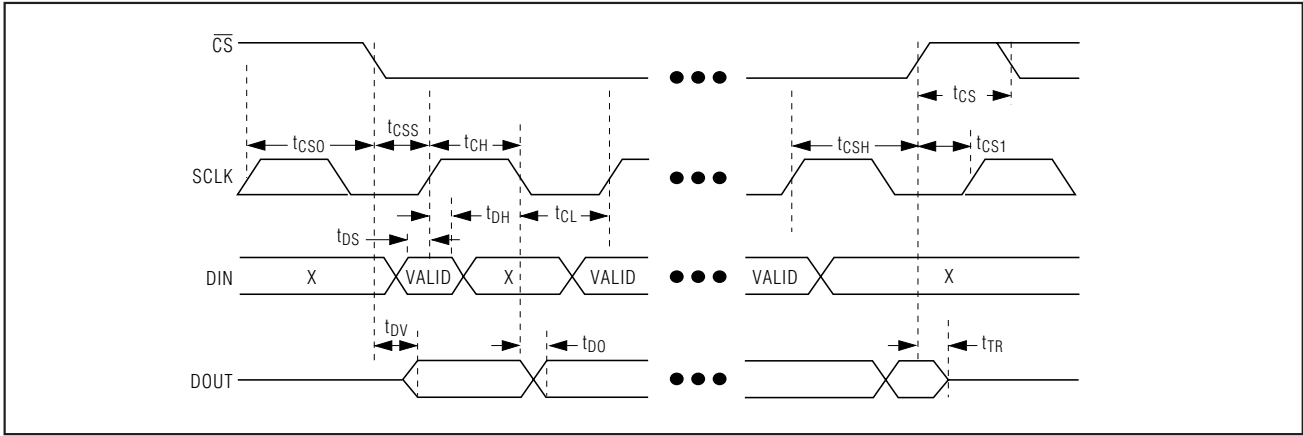

Figure 4. Detailed Serial Interface Timing

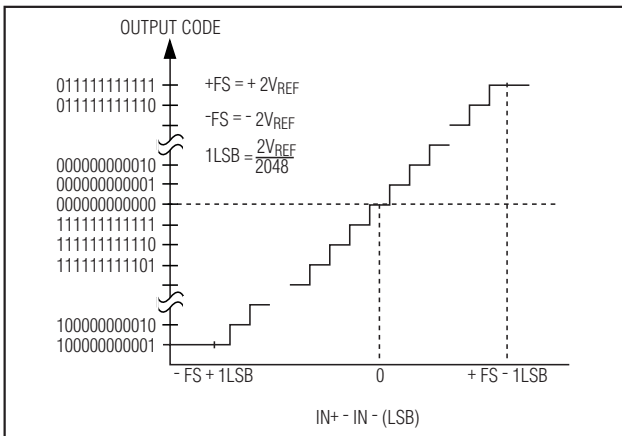

Figure 5. Bipolar Transfer Function

### Input Data Format

Input data (configuration and conversion bytes) are clocked into the MAX1298/MAX1299 at DIN on the rising edge of SCLK when  $\overline{CS}$  is low. The start bit (MSB) of an input data byte is the first logic 1 bit that arrives:

After  $\overline{CS}$  falls,

OR

after receipt of a complete configuration byte with no conversion in progress,

OR

after 16 bits have been clocked onto DOUT following a conversion.

### Output Data Format

Output data from the MAX1298/MAX1299 are clocked onto DOUT on the falling edge of SCLK in the form of two

8-bit words, MSB first (Table 1). For temperature conversions, the output is 12-bit binary (D10–S0) padded with 2 leading extraneous bits and two trailing zeros. For voltage conversions, the output is 12-bit two's-complement binary (D11–D0) with 1 sub-bit and two trailing zeros. Figure 5 shows the bipolar transfer function.

### Performing a Conversion

On power-up, the MAX1298/MAX1299 defaults to shut-down mode. Start a conversion by transferring a configuration byte and a conversion byte into DIN with the control formats shown in Tables 2 and 3, respectively. (See *Power Modes* for related discussion.)

SSTRB goes low on the falling edge of the last bit of the conversion byte, and it returns high when the conversion is complete. For best noise performance, SCLK should remain low while SSTRB is low. Typical conversion times are 2.2ms for temperature measurements and 1.1ms for voltage measurements. The MSB of the 2 output bytes is present at DOUT starting at the rising edge of SSTRB. Successive SCLK falling edges shift the two 8-bit data bytes out from an internal register. Additional (>16) SCLK edges will result in zeros on DOUT.

SSTRB does not go into a high-impedance state when  $\overline{CS}$  goes high. Pulling  $\overline{CS}$  high prevents data from being clocked in or out, but it does not adversely affect a conversion in progress. Figure 6 shows SSTRB timing details.

Subsequent conversions with the same reference mode do not require a configuration byte.

### Reference Selection

Select between internal and external voltage modes through bit REF of the configuration byte. Set REF = 1 for internal reference mode and REF = 0 for external reference mode.

# 12-Bit Serial-Output Temperature Sensors with 5-Channel ADC

**Table 1. Output Data Format**

D11	D11	D10	D9	D8	D7	D6	D5	D4	D3	D2	D1	D0	S0	0	0
-----	-----	-----	----	----	----	----	----	----	----	----	----	----	----	---	---

**Table 2. Configuration-Byte Format**

BIT 7 (MSB)	BIT 6	BIT 5	BIT 4	BIT 3	BIT 2	BIT 1	BIT 0 (LSB)
Start	0	0	0	0	PM1	PM0	REF
BIT	NAME	DESCRIPTION					
7 (MSB)	Start	First logic 1 after $\overline{CS}$ goes low. (See <i>Input Data Format</i> .)					
6, 5, 4, 3		Must be 0000 to load a configuration byte.					
2, 1	PM1, PM0	These 2 bits select the desired power mode (Table 4).					
0	REF	A logic high enables the internal reference. A logic low disables the internal reference and selects the external reference mode.					

**Table 3. Conversion-Byte Format**

BIT 7 (MSB)	BIT 6	BIT 5	BIT 4	BIT 3	BIT 2	BIT 1	BIT 0 (LSB)
Start	0	1	0	SEL3	SEL2	SEL1	SELO
BIT	NAME	DESCRIPTION					
7 (MSB)	Start	First logic 1 after $\overline{CS}$ goes low. (See <i>Input Data Format</i> .)					
6, 5, 4		Must be 010 to load a conversion byte.					
3, 2, 1, 0	SEL3, SEL2, SEL1, SELO	These 4 bits select the input configuration (Table 5).					

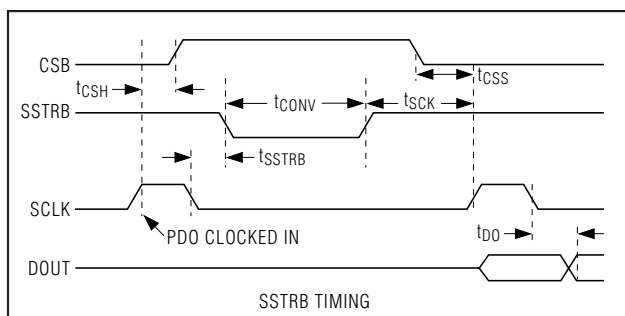

Figure 6. Detailed SSTRB Timing

### Internal Reference

The MAX1298 has a 2.50V internal reference, while the MAX1299 has a 1.20V internal reference. Both are factory trimmed for accuracy. When internal reference is selected, REF can be used to drive an external load with 100µA capability. Bypass REF to GND with a 0.1µF

(min) capacitance. Wake-up time is  $C \times 2.5 \times 10^4$ s for the MAX1298 and  $C \times 1.2 \times 10^4$ s for the MAX1299.

### External Reference

The MAX1298 can directly accept reference voltages at REF from 0.8V to 2.5V, while the MAX1299 can directly accept reference voltages from 0.8V to 1.2V. Bypass REF to GND with a 0.1µF capacitor. Temperature measurements always use internal reference.

### Power Modes

The MAX1298 (MAX1299) typically requires supply currents of 380µA (350µA) or 310µA (280µA) when performing voltage conversions at 100% duty cycle with internal or external references, respectively. The difference reflects the power requirement of an internal reference buffer amplifier that can accommodate external loads. Temperature conversions at 100% duty cycle increase supply currents to 440µA (400µA) through additional amplification, buffer, and bias circuitry that is otherwise inactive.



# 12-Bit Serial-Output Temperature Sensors with 5-Channel ADC

Place the MAX1298/MAX1299 in a low-current power-down state between conversions to conserve power. Select standby, standby-plus, or shutdown through bits PM1 and PM0 of the initialization byte (Table 4).

The MAX1298/MAX1299 assume the shutdown power mode when V<sub>DD</sub> is first applied.

### Standby Mode

Standby mode turns off the MAX1298/MAX1299 ADC, internal clock, and reference buffer amplifier. Special circuitry for temperature conversions is also deactivated. Wake-up time is limited by the reference buffer amplifier and the associated bypass capacitor (see *Internal Reference*). When an external reference is used, wake-up time is 0.1ms.

### Standby-Plus Mode

Standby-plus mode is similar to the standby mode, but the internal reference output buffer remains active to shorten the wake-up time to 0.1ms for internal reference mode. When using an external reference, standby-plus mode is equivalent to standby mode.

### Shutdown Mode

Shutdown mode turns off all functions other than start-up circuitry, thereby reducing typical supply current to 2μA. Data registers are cleared. Use this power mode when interconversion times are no less than 5ms.

### Monitoring V<sub>DD</sub>

This mode of operation samples and converts the supply voltage, V<sub>DD</sub>/4, which is internally generated. The reference voltage must be larger than V<sub>DD</sub>/8 for the operation to work properly. From the result of a conversion (CODE), CODE = 256 V<sub>DD</sub> / V<sub>REF</sub>.

### Temperature Measurements

The MAX1298/MAX1299 perform temperature measurements with internal or external diode-connected transistors through a three-step process. First, the diode bias current changes from 31.6μA to 10μA to produce a temperature-dependent bias voltage difference, which is amplified by a factor of 20 and converted to digital format. Second, the bias current changes from 31.6μA to 100μA, and the bias voltage difference is similarly amplified by a factor of 20 and converted to digital format. Third, the intermediate results are subtracted to achieve a digital output that is proportional to absolute temperature in degrees Kelvin.

The reference voltage used in conjunction with temperature measurements is derived from the internal reference source to ensure that 1LSB corresponds to 1/8 of a degree. To convert to degrees Celsius, subtract 273.15 from the temperature inferred from the ADC output.

Temperature measurements require a conversion time of 2.2ms.

### Shield Output Buffer

The MAX1298/MAX1299 provide a shield output buffer voltage at SHO that is approximately 0.6V (one diode drop) above V<sub>DD</sub>/2. When performing temperature measurements with an external diode, use this voltage to suppress error-producing leakage currents (see *Remote Diode Shielding*). Figure 7 shows the SHO output circuit.

## Applications Information

### Remote Diode Selection

Temperature accuracy depends on having a good-quality, diode-connected small-signal transistor. Accuracy has been experimentally verified for 2N3904 devices. CPUs and other ICs having on-board temperature-sensing diodes can also be monitored if the diode connections are uncommitted.

The transistor must be a small-signal type with a base resistance less than 100Ω. Tight specifications for forward current gain (+50 to +150, for example) indicate that the manufacturer has good process controls and that the devices have consistent V<sub>BE</sub> characteristics. (See Table 6 for recommended devices.)

For heatsink mounting, the 500-32BT02-000 thermal sensor from Fenwal Electronics is a good choice. This device consists of a diode-connected transistor, an aluminum plate with screw hole, and twisted-pair cable (Fenwal Inc., Milford MA, 508-478-6000).

**Table 4. Power-Mode Selection**

PM1	PM0	MODE
0	0	Shutdown
0	1	Standby-plus
1	0	Standby
1	1	Normal operation

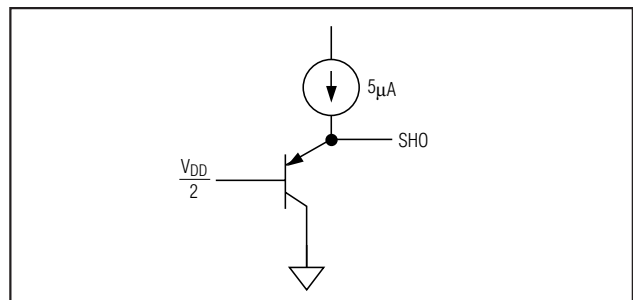

Figure 7. SHO Output Circuit

## 12-Bit Serial-Output Temperature Sensors with 5-Channel ADC

Table 5. Input Selection

SEL3	SEL2	SEL1	SEL0	POSITIVE INPUT (IN+)	NEGATIVE INPUT (IN-)
0	0	0	0	AIN0	AIN5
0	0	0	1	AIN1	AIN5
0	0	1	0	AIN2	AIN5
0	0	1	1	AIN3	AIN5
0	1	0	0	AIN4	AIN5
0	1	0	1	—	—
0	1	1	0	AIN5	AIN5
0	1	1	1	Internal diode anode*	Internal diode cathode
1	0	0	0	AIN0	AIN1
1	0	0	1	AIN2	AIN3
1	0	1	0	—	—
1	0	1	1	V <sub>DD</sub> /4	GND
1	1	0	0	External diode 1 anode* (AIN0)	External diode 1 cathode (AIN1)
1	1	0	1	External diode 2 anode* (AIN2)	External diode 2 cathode (AIN3)
1	1	1	0	—	—
1	1	1	1	—	—

\*Temperature-measurement mode

Table 6. Remote-Sensor Transistor Manufacturer

MANUFACTURER	MODEL NUMBER
Central Semiconductor (USA)	CMPT3904
Fairchild Semiconductor (USA)	MMBT3904
Motorola (USA)	MMBT3904
Rohm Semiconductor (Japan)	SST3904
Siemens (Germany)	SMB3904
Zetex (England)	FMMT3904CT-ND

### Twisted-Pair and Shielded Cables

For remote-sensor distances greater than 8 inches, or in particularly noisy environments, use a twisted pair. A

practical length is 6 to 12 feet. For longer distances, the best solution is a shielded twisted pair such as that used for audio microphones. For example, the Belden 8451 works well for distances up to 100 feet in a noisy environment. Connect the shield to SHO.

Cable resistances affect remote-sensor accuracy; 1Ω series resistance introduces +0.004°C error.

### Remote Diode Shielding

Temperature measurements will reflect significant error if a portion of the bias current supplied to the diode anode is allowed to flow through parallel paths to ground. If the diode-connected transistor is mounted on a PC board, suppress error-producing “leakage” current by surrounding the collector/base leads with a metal trace that is connected to the SHO shield output (Figure 8).

## 12-Bit Serial-Output Temperature Sensors with 5-Channel ADC

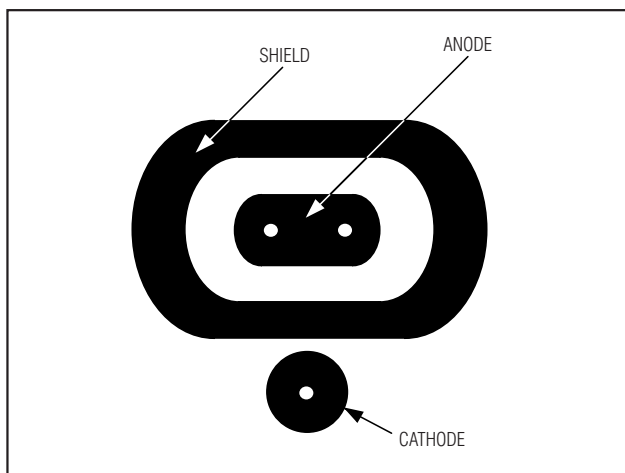

Figure 8. Remote Diode Shielding for PC Boards

### Layout, Grounding, and Bypassing

For best performance, use PC boards. Do not use wire-wrap boards. Board layout should ensure that digital and analog signal lines are separated from each other. Do not run analog and digital (especially clock) signals parallel to one another or run digital lines underneath the ADC package.

High-frequency noise in the  $V_{DD}$  power supply may affect ADC performance. Bypass the supply with a  $0.1\mu\text{F}$  capacitor close to pin  $V_{DD}$ . Minimize capacitor lead lengths for best supply-noise rejection. If the power supply is very noisy, connect a  $10\Omega$  resistor in series with the supply to provide lowpass filtering.

### Definitions

#### Relative Accuracy

Relative accuracy is the deviation of the values on an actual transfer function from a straight line. This straight line can be either a best-straight-line fit or a line drawn

between the endpoints of the transfer function, once offset and gain errors have been nullified. The static linearity parameters for the MAX1298/MAX1299 are measured using the best-straight-line-fit method.

#### Differential Nonlinearity (DNL)

Differential nonlinearity is the difference between an actual step width and the ideal value of 1LSB. A DNL error specification of less than 1LSB guarantees no missing codes and a monotonic transfer function.

#### Offset Error

The offset error is the difference between the ideal and the actual offset points. For an ADC, the offset point is the midstep value when the digital output is zero.

#### Gain Error

The gain or full-scale error is the difference between the ideal and actual gain points on the transfer function, after the offset error has been canceled out. For an ADC, the gain point is the midstep value when the digital output is full scale.

#### Aperture Delay

Aperture delay ( $t_{AD}$ ) is the time defined between the rising edge of the sampling clock and the instant when an actual sample is taken.

### Chip Information

PROCESS: BiCMOS

# 12-Bit Serial-Output Temperature Sensors with 5-Channel ADC

## Typical Operating Circuit

**MAX1298/MAX1299**

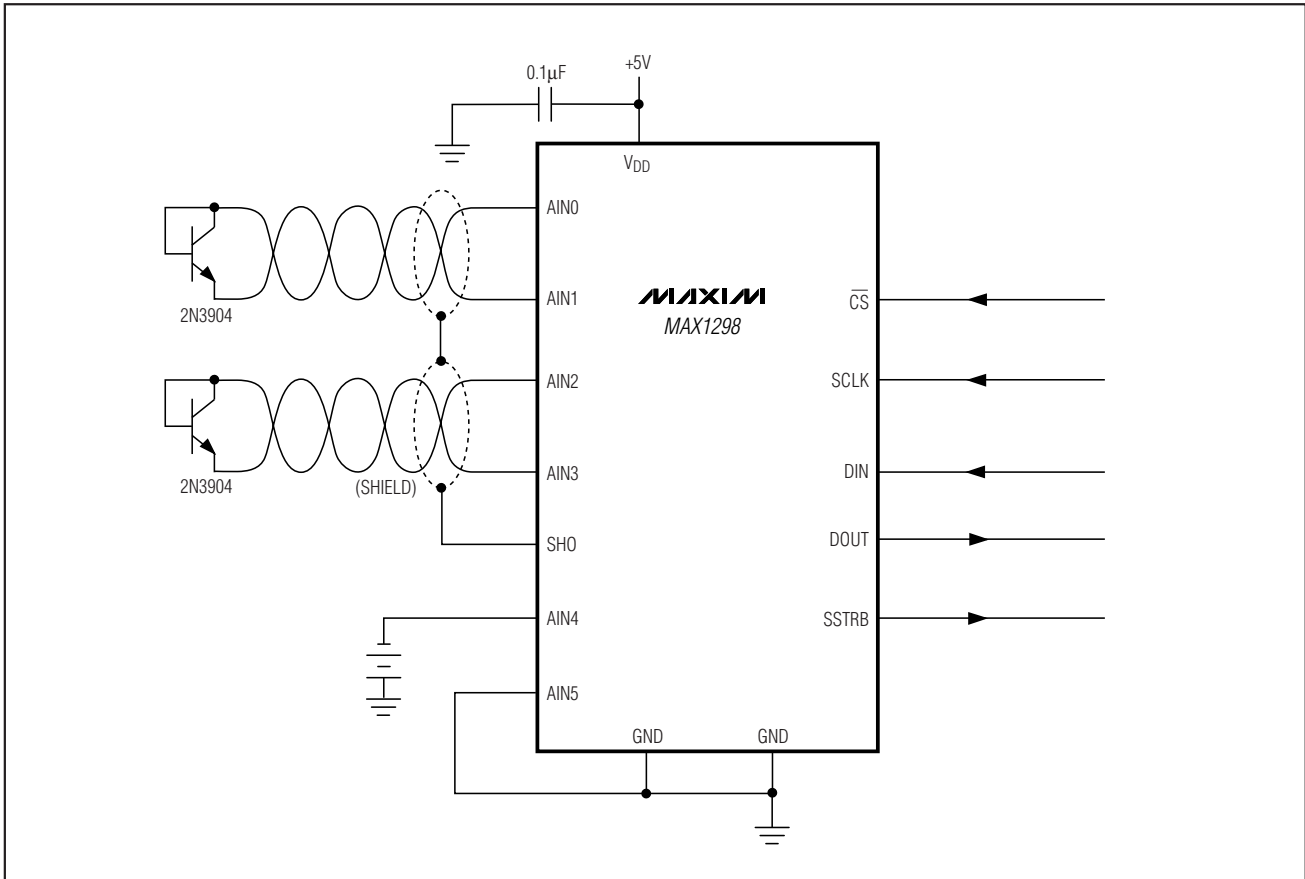

### Package Information

For the latest package outline information and land patterns (footprints), go to [www.maxim-ic.com/packages](http://www.maxim-ic.com/packages). Note that a "+", "#", or "-" in the package code indicates RoHS status only. Package drawings may show a different suffix character, but the drawing pertains to the package regardless of RoHS status.

PACKAGE TYPE	PACKAGE CODE	OUTLINE NO.	LAND PATTERN NO.
16 SSOP	A16+3	<a href="#">21-0056</a>	<a href="#">90-0106</a>

# 12-Bit Serial-Output Temperature Sensors with 5-Channel ADC

**MAX1298/MAX1299**

## Revision History

REVISION NUMBER	REVISION DATE	DESCRIPTION	PAGES CHANGED
0	5/00	Initial release	—
1	3/12	Revised <i>Ordering Information, Absolute Maximum Ratings, Electrical Characteristics.</i>	1, 2, 4

Maxim cannot assume responsibility for use of any circuitry other than circuitry entirely embodied in a Maxim product. No circuit patent licenses are implied. Maxim reserves the right to change the circuitry and specifications without notice at any time. The parametric values (min and max limits) shown in the Electrical Characteristics table are guaranteed. Other parametric values quoted in this data sheet are provided for guidance.

20 \_\_\_\_\_ **Maxim Integrated Products, 120 San Gabriel Drive, Sunnyvale, CA 94086 408-737-7600**