

## Excellent Integrated System Limited

Stocking Distributor

Click to view price, real time Inventory, Delivery & Lifecycle Information:

[ON Semiconductor](#)  
[2N6027RL1](#)

For any questions, you can email us directly:

[sales@integrated-circuit.com](mailto:sales@integrated-circuit.com)

# 2N6027, 2N6028

Preferred Device

## Programmable Unijunction Transistor

### Programmable Unijunction Transistor Triggers

Designed to enable the engineer to “program” unijunction characteristics such as  $R_{BB}$ ,  $\eta$ ,  $I_V$ , and  $I_P$  by merely selecting two resistor values. Application includes thyristor-trigger, oscillator, pulse and timing circuits. These devices may also be used in special thyristor applications due to the availability of an anode gate. Supplied in an inexpensive TO-92 plastic package for high-volume requirements, this package is readily adaptable for use in automatic insertion equipment.

- Programmable —  $R_{BB}$ ,  $\eta$ ,  $I_V$  and  $I_P$
- Low On-State Voltage — 1.5 Volts Maximum @  $I_F = 50$  mA
- Low Gate to Anode Leakage Current — 10 nA Maximum
- High Peak Output Voltage — 11 Volts Typical
- Low Offset Voltage — 0.35 Volt Typical ( $R_G = 10$  k ohms)
- Device Marking: Logo, Device Type, e.g., 2N6027, Date Code

#### MAXIMUM RATINGS ( $T_J = 25^\circ\text{C}$ unless otherwise noted)

Rating	Symbol	Value	Unit
*Power Dissipation Derate Above $25^\circ\text{C}$	$P_F$ $1/\theta_{JA}$	300 4.0	mW mW/ $^\circ\text{C}$
*DC Forward Anode Current Derate Above $25^\circ\text{C}$	$I_T$	150 2.67	mA mA/ $^\circ\text{C}$
*DC Gate Current	$I_G$	$\pm 50$	mA
Repetitive Peak Forward Current 100 $\mu\text{s}$ Pulse Width, 1% Duty Cycle *20 $\mu\text{s}$ Pulse Width, 1% Duty Cycle	$I_{TRM}$	1.0 2.0	Amps
Non-Repetitive Peak Forward Current 10 $\mu\text{s}$ Pulse Width	$I_{TSM}$	5.0	Amps
*Gate to Cathode Forward Voltage	$V_{GKF}$	40	Volts
*Gate to Cathode Reverse Voltage	$V_{GKR}$	-5.0	Volts
*Gate to Anode Reverse Voltage	$V_{GAR}$	40	Volts
*Anode to Cathode Voltage <sup>(1)</sup>	$V_{AK}$	$\pm 40$	Volts
Operating Junction Temperature Range	$T_J$	-50 to +100	$^\circ\text{C}$
*Storage Temperature Range	$T_{stg}$	-55 to +150	$^\circ\text{C}$

\*Indicates JEDEC Registered Data

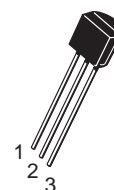
(1) Anode positive,  $R_{GA} = 1000$  ohms  
 Anode negative,  $R_{GA} = \text{open}$



ON Semiconductor

<http://onsemi.com>

PUTs  
 40 VOLTS  
 300 mW



TO-92 (TO-226AA)  
 CASE 029  
 STYLE 16

#### PIN ASSIGNMENT

Pin	Assignment
1	Anode
2	Gate
3	Cathode

#### ORDERING INFORMATION

See detailed ordering and shipping information in the package dimensions section on page 7 of this data sheet.

Preferred devices are recommended choices for future use and best overall value.

**2N6027, 2N6028**
**THERMAL CHARACTERISTICS**

Characteristic	Symbol	Max	Unit
Thermal Resistance, Junction to Case	$R_{\theta JC}$	75	$^{\circ}C/W$
Thermal Resistance, Junction to Ambient	$R_{\theta JA}$	200	$^{\circ}C/W$
Maximum Lead Temperature for Soldering Purposes ( $< 1/16''$ from case, 10 secs max)	$T_L$	260	$^{\circ}C$

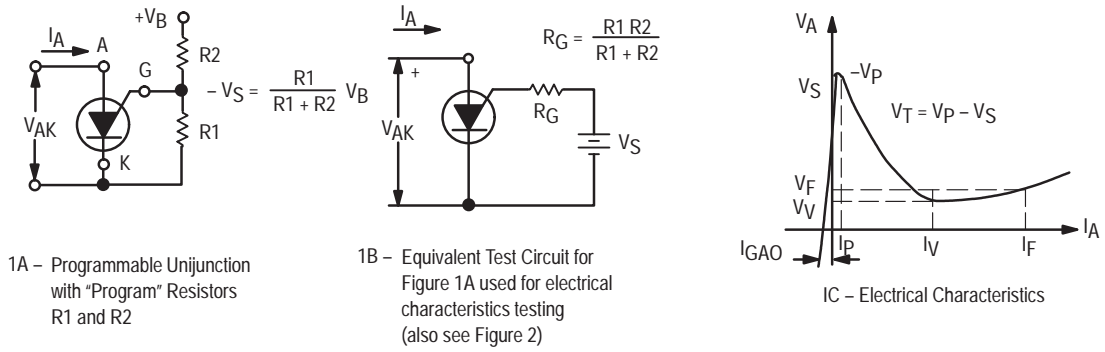
**ELECTRICAL CHARACTERISTICS** ( $T_C = 25^{\circ}C$  unless otherwise noted.)

Characteristic	Fig. No.	Symbol	Min	Typ	Max	Unit	
*Peak Current ( $V_S = 10$ Vdc, $R_G = 1$ M $\Omega$ )	2,9,11	$I_P$	—	1.25	2.0	$\mu A$	
2N6027			—	0.08	0.15		
( $V_S = 10$ Vdc, $R_G = 10$ k ohms)	2N6027 2N6028		—	4.0	5.0		
2N6028			—	0.70	1.0		
*Offset Voltage ( $V_S = 10$ Vdc, $R_G = 1$ M $\Omega$ )	1	$V_T$	0.2	0.70	1.6	Volts	
2N6027			0.2	0.50	0.6		
( $V_S = 10$ Vdc, $R_G = 10$ k ohms) (Both Types)			0.2	0.35	0.6		
*Valley Current ( $V_S = 10$ Vdc, $R_G = 1$ M $\Omega$ )	1,4,5	$I_V$	—	18	50	$\mu A$	
2N6027			—	18	25		
( $V_S = 10$ Vdc, $R_G = 10$ k ohms)			2N6027	70	150	—	mA
2N6028			25	150	—		
( $V_S = 10$ Vdc, $R_G = 200$ ohms)	2N6027	1.5	—	—			
2N6028	1.0	—	—				
*Gate to Anode Leakage Current ( $V_S = 40$ Vdc, $T_A = 25^{\circ}C$ , Cathode Open) ( $V_S = 40$ Vdc, $T_A = 75^{\circ}C$ , Cathode Open)	—	$I_{GAO}$	—	1.0	10	nAdc	
( $V_S = 40$ Vdc, $T_A = 75^{\circ}C$ , Cathode Open)			—	3.0	—		
Gate to Cathode Leakage Current ( $V_S = 40$ Vdc, Anode to Cathode Shorted)	—	$I_{GKS}$	—	5.0	50	nAdc	
*Forward Voltage ( $I_F = 50$ mA Peak) <sup>(1)</sup>	1,6	$V_F$	—	0.8	1.5	Volts	
*Peak Output Voltage ( $V_G = 20$ Vdc, $C_C = 0.2$ $\mu F$ )	3,7	$V_O$	6.0	11	—	Volt	
Pulse Voltage Rise Time ( $V_B = 20$ Vdc, $C_C = 0.2$ $\mu F$ )	3	$t_r$	—	40	80	ns	

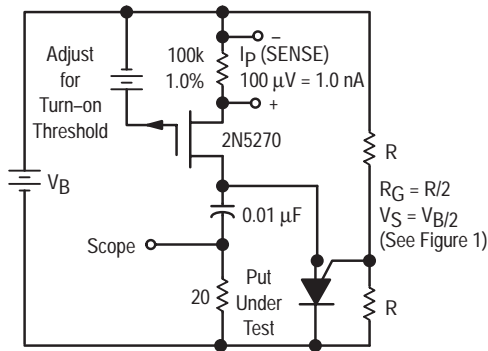
\*Indicates JEDEC Registered Data

 (1) Pulse Test: Pulse Width  $\leq 300$   $\mu$ sec, Duty Cycle  $\leq 2\%$ .

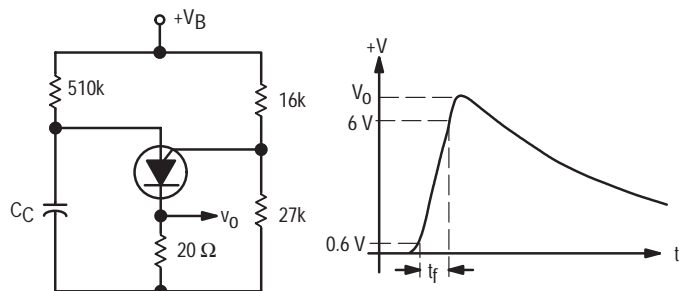
**2N6027, 2N6028**



**Figure 1. Electrical Characterization**



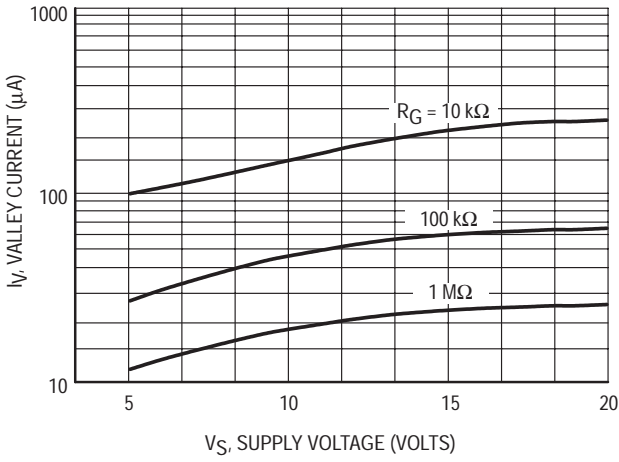
**Figure 2. Peak Current (Ip) Test Circuit**



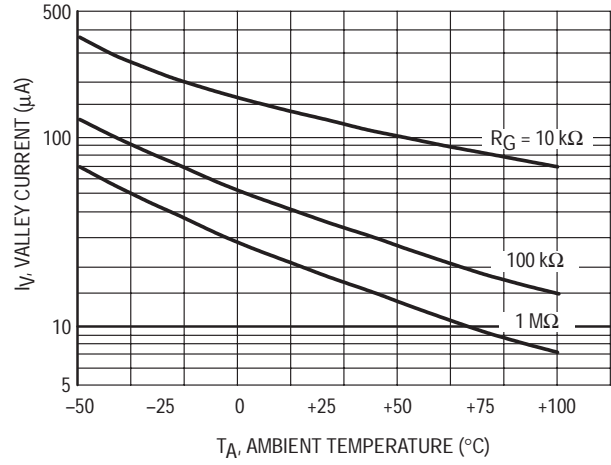
**Figure 3. V<sub>0</sub> and t<sub>r</sub> Test Circuit**

**2N6027, 2N6028**

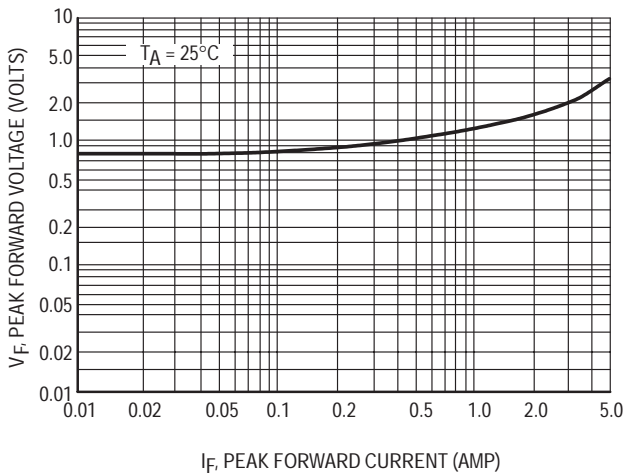
**TYPICAL VALLEY CURRENT BEHAVIOR**



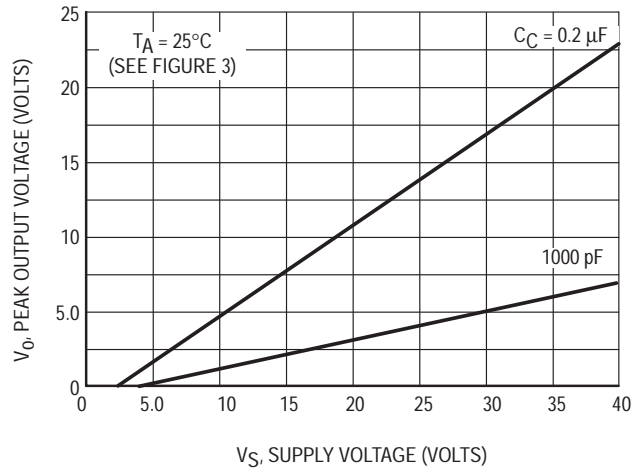
**Figure 4. Effect of Supply Voltage**



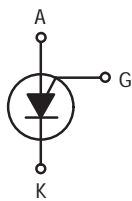
**Figure 5. Effect of Temperature**



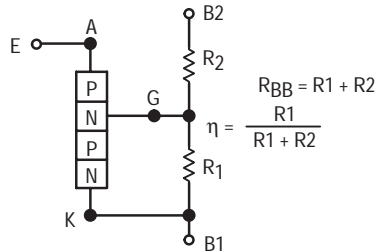
**Figure 6. Forward Voltage**



**Figure 7. Peak Output Voltage**



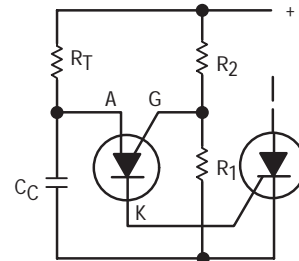
Circuit Symbol



Equivalent Circuit  
with External "Program"  
Resistors R1 and R2

$$R_{BB} = R_1 + R_2$$

$$\eta = \frac{R_1}{R_1 + R_2}$$



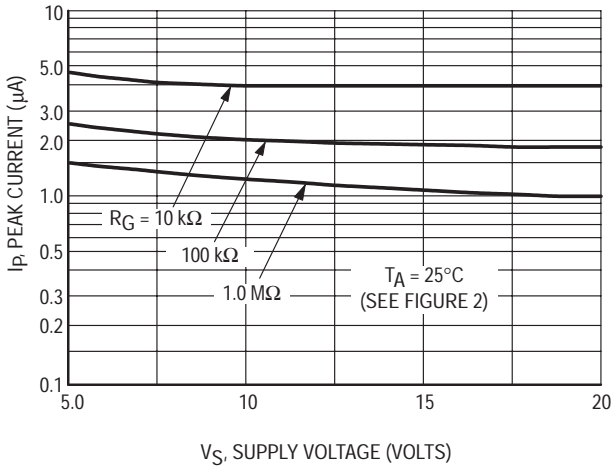
Typical Application

**Figure 8. Programmable Unijunction**

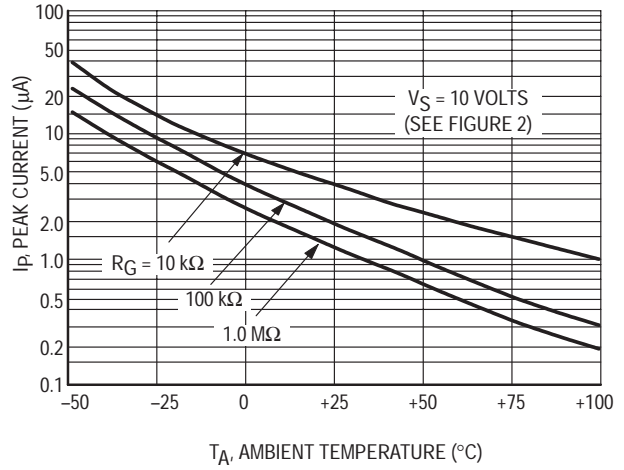
**2N6027, 2N6028**

**TYPICAL PEAK CURRENT BEHAVIOR**

**2N6027**

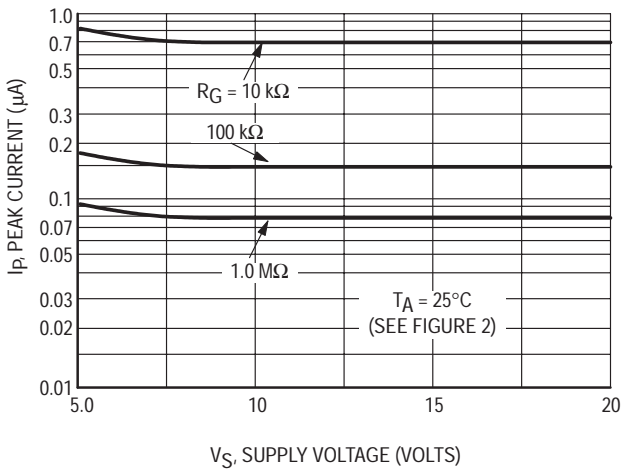


**Figure 9. Effect of Supply Voltage and  $R_G$**

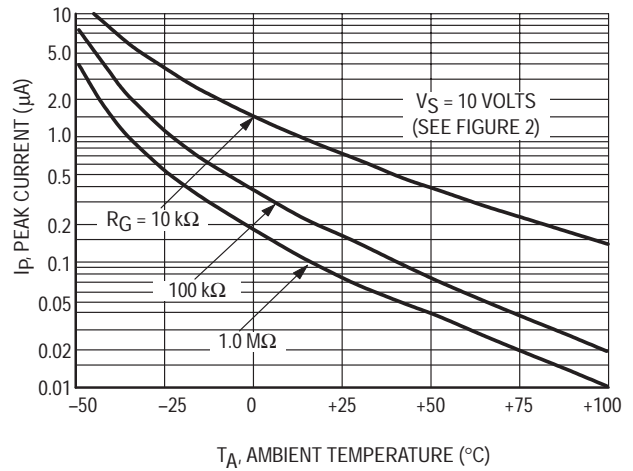


**Figure 10. Effect of Temperature and  $R_G$**

**2N6028**



**Figure 11. Effect of Supply Voltage and  $R_G$**



**Figure 12. Effect of Temperature and  $R_G$**

## 2N6027, 2N6028

### TO-92 EIA RADIAL TAPE IN FAN FOLD BOX OR ON REEL

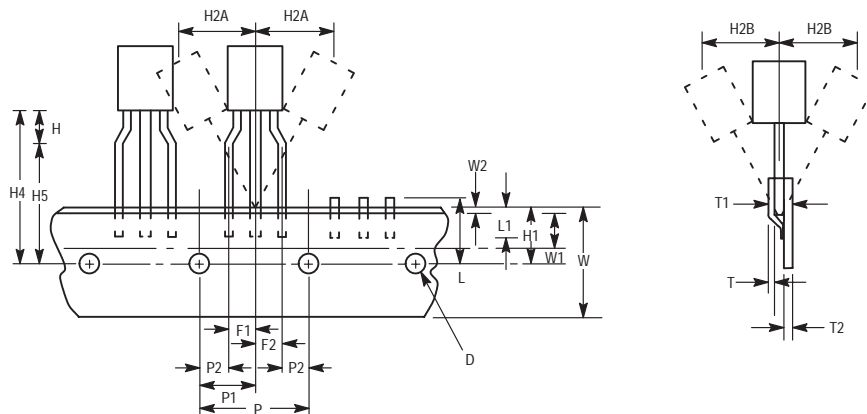


Figure 13. Device Positioning on Tape

Symbol	Item	Specification			
		Inches		Millimeter	
		Min	Max	Min	Max
D	Tape Feedhole Diameter	0.1496	0.1653	3.8	4.2
D2	Component Lead Thickness Dimension	0.015	0.020	0.38	0.51
F1, F2	Component Lead Pitch	0.0945	0.110	2.4	2.8
H	Bottom of Component to Seating Plane	.059	.156	1.5	4.0
H1	Feedhole Location	0.3346	0.3741	8.5	9.5
H2A	Deflection Left or Right	0	0.039	0	1.0
H2B	Deflection Front or Rear	0	0.051	0	1.0
H4	Feedhole to Bottom of Component	0.7086	0.768	18	19.5
H5	Feedhole to Seating Plane	0.610	0.649	15.5	16.5
L	Defective Unit Clipped Dimension	0.3346	0.433	8.5	11
L1	Lead Wire Enclosure	0.09842	—	2.5	—
P	Feedhole Pitch	0.4921	0.5079	12.5	12.9
P1	Feedhole Center to Center Lead	0.2342	0.2658	5.95	6.75
P2	First Lead Spacing Dimension	0.1397	0.1556	3.55	3.95
T	Adhesive Tape Thickness	0.06	0.08	0.15	0.20
T1	Overall Taped Package Thickness	—	0.0567	—	1.44
T2	Carrier Strip Thickness	0.014	0.027	0.35	0.65
W	Carrier Strip Width	0.6889	0.7481	17.5	19
W1	Adhesive Tape Width	0.2165	0.2841	5.5	6.3
W2	Adhesive Tape Position	.0059	0.01968	.15	0.5

NOTES:

1. Maximum alignment deviation between leads not to be greater than 0.2 mm.
2. Defective components shall be clipped from the carrier tape such that the remaining protrusion (L) does not exceed a maximum of 11 mm.
3. Component lead to tape adhesion must meet the pull test requirements.
4. Maximum non-cumulative variation between tape feed holes shall not exceed 1 mm in 20 pitches.
5. Holddown tape not to extend beyond the edge(s) of carrier tape and there shall be no exposure of adhesive.
6. No more than 1 consecutive missing component is permitted.
7. A tape trailer and leader, having at least three feed holes is required before the first and after the last component.
8. Splices will not interfere with the sprocket feed holes.

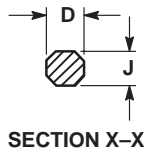
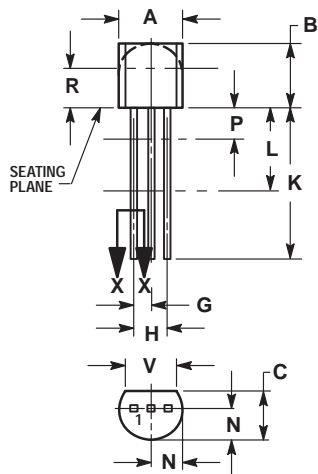
## 2N6027, 2N6028

### ORDERING & SHIPPING INFORMATION: 2N6027 and 2N6028 packaging options, Device Suffix

U.S.	Europe Equivalent	Shipping	Description of TO92 Tape Orientation
2N6027, 2N6028 2N6027, 2N6028RLRA	2N6027RL1	Bulk in Box (5K/Box)	N/A, Bulk
		Radial Tape and Reel (2K/Reel)	Round side of TO92 and adhesive tape visible
2N6028RLRM		Radial Tape and Reel (2K/Reel)	Flat side of TO92 and adhesive tape visible
2N6028RLRP		Radial Tape and Fan Fold Box (2K/Box)	Flat side of TO92 and adhesive tape visible
		Radial Tape and Fan Fold Box (2K/Box)	Round side of TO92 and adhesive tape visible

### PACKAGE DIMENSIONS

#### TO-92 (TO-226AA) CASE 029-11 ISSUE AJ



#### NOTES:

1. DIMENSIONING AND TOLERANCING PER ANSI Y14.5M, 1982.
2. CONTROLLING DIMENSION: INCH.
3. CONTOUR OF PACKAGE BEYOND DIMENSION R IS UNCONTROLLED.
4. LEAD DIMENSION IS UNCONTROLLED IN P AND BEYOND DIMENSION K MINIMUM.


DIM	INCHES		MILLIMETERS	
	MIN	MAX	MIN	MAX
A	0.175	0.205	4.45	5.20
B	0.170	0.210	4.32	5.33
C	0.125	0.165	3.18	4.19
D	0.016	0.021	0.407	0.533
G	0.045	0.055	1.15	1.39
H	0.095	0.105	2.42	2.66
J	0.015	0.020	0.39	0.50
K	0.500	---	12.70	---
L	0.250	---	6.35	---
N	0.080	0.105	2.04	2.66
P	---	0.100	---	2.54
R	0.115	---	2.93	---
V	0.135	---	3.43	---

#### STYLE 16:

- PIN 1: ANODE
- GATE
- CATHODE



## 2N6027, 2N6028

ON Semiconductor and  are trademarks of Semiconductor Components Industries, LLC (SCILLC). SCILLC reserves the right to make changes without further notice to any products herein. SCILLC makes no warranty, representation or guarantee regarding the suitability of its products for any particular purpose, nor does SCILLC assume any liability arising out of the application or use of any product or circuit, and specifically disclaims any and all liability, including without limitation special, consequential or incidental damages. "Typical" parameters which may be provided in SCILLC data sheets and/or specifications can and do vary in different applications and actual performance may vary over time. All operating parameters, including "Typicals" must be validated for each customer application by customer's technical experts. SCILLC does not convey any license under its patent rights nor the rights of others. SCILLC products are not designed, intended, or authorized for use as components in systems intended for surgical implant into the body, or other applications intended to support or sustain life, or for any other application in which the failure of the SCILLC product could create a situation where personal injury or death may occur. Should Buyer purchase or use SCILLC products for any such unintended or unauthorized application, Buyer shall indemnify and hold SCILLC and its officers, employees, subsidiaries, affiliates, and distributors harmless against all claims, costs, damages, and expenses, and reasonable attorney fees arising out of, directly or indirectly, any claim of personal injury or death associated with such unintended or unauthorized use, even if such claim alleges that SCILLC was negligent regarding the design or manufacture of the part. SCILLC is an Equal Opportunity/Affirmative Action Employer.

### PUBLICATION ORDERING INFORMATION

#### NORTH AMERICA Literature Fulfillment:

Literature Distribution Center for ON Semiconductor  
P.O. Box 5163, Denver, Colorado 80217 USA  
**Phone:** 303-675-2175 or 800-344-3860 Toll Free USA/Canada  
**Fax:** 303-675-2176 or 800-344-3867 Toll Free USA/Canada  
**Email:** ONlit@hibbertco.com  
Fax Response Line: 303-675-2167 or 800-344-3810 Toll Free USA/Canada

**N. American Technical Support:** 800-282-9855 Toll Free USA/Canada

**EUROPE:** LDC for ON Semiconductor – European Support

**German Phone:** (+1) 303-308-7140 (M-F 1:00pm to 5:00pm Munich Time)  
**Email:** ONlit\_german@hibbertco.com  
**French Phone:** (+1) 303-308-7141 (M-F 1:00pm to 5:00pm Toulouse Time)  
**Email:** ONlit\_french@hibbertco.com  
**English Phone:** (+1) 303-308-7142 (M-F 12:00pm to 5:00pm UK Time)  
**Email:** ONlit@hibbertco.com

**EUROPEAN TOLL-FREE ACCESS\*: 00-800-4422-3781**

\*Available from Germany, France, Italy, England, Ireland

#### CENTRAL/SOUTH AMERICA:

**Spanish Phone:** 303-308-7143 (Mon-Fri 8:00am to 5:00pm MST)  
**Email:** ONlit-spanish@hibbertco.com

**ASIA/PACIFIC:** LDC for ON Semiconductor – Asia Support

**Phone:** 303-675-2121 (Tue-Fri 9:00am to 1:00pm, Hong Kong Time)  
Toll Free from Hong Kong & Singapore:  
**001-800-4422-3781**  
**Email:** ONlit-asia@hibbertco.com

**JAPAN:** ON Semiconductor, Japan Customer Focus Center  
4-32-1 Nishi-Gotanda, Shinagawa-ku, Tokyo, Japan 141-8549

**Phone:** 81-3-5740-2745  
**Email:** r14525@onsemi.com

**ON Semiconductor Website:** <http://onsemi.com>

For additional information, please contact your local Sales Representative.