

Excellent Integrated System Limited

Stocking Distributor

Click to view price, real time Inventory, Delivery & Lifecycle Information:

[Maxim Integrated](#)
[MAX8532EBTJ+T](#)

For any questions, you can email us directly:

sales@integrated-circuit.com

19-2733; Rev 1; 2/12



Low-Noise, Low-Dropout, 200mA Linear Regulator in UCSP

MAX8532

General Description

The MAX8532 offers the benefits of low-dropout voltage and ultra-low power regulation in a subminiaturized UCSP, making it ideal for space-restricted portable equipment. The device operates from a 2.5V to 6.5V input and delivers up to 200mA, with low dropout of 100mV (typ) at 100mA. Designed with an internal P-channel MOSFET pass transistor, the supply current is kept at a low 80µA, independent of the load current and dropout voltage. Other features include short-circuit protection and thermal-shutdown protection.

The MAX8532 includes a reference bypass pin for low output noise (40µV_{RMS}) and a logic-controlled shutdown input. The device is available in a tiny 6-pin UCSP.

Applications

- Cellular and Cordless Phones
- PDA's and Palmtop Computers
- Notebook Computers
- Digital Cameras
- PCMCIA Cards
- Wireless LAN Cards
- Hand-Held Instruments

Features

- ◆ Guaranteed 200mA Output Current
- ◆ Low 100mV (typ) Dropout at 100mA
- ◆ Low 40µV_{RMS} Output Noise
- ◆ Low 80µA Operating Supply Current
- ◆ 62dB PSRR
- ◆ < 1µA Shutdown Current
- ◆ Thermal-Overload and Short-Circuit Protection
- ◆ Output Current Limit
- ◆ Tiny 1.16mm x 1.57mm x 0.66mm UCSP (3 x 2 Grid)

Ordering Information

PART	TEMP RANGE	OUT VOLTAGE	PIN-PACKAGE
MAX8532EBT_*	-40°C to +85°C	1.5V to 3.3V	6 UCSP

*"_" = Output voltage code (see the Output Voltage Selector Guide).

Note: Devices are also available in a lead(Pb)-free/RoHS-compliant package. Specify lead-free by adding "+" to the part number when ordering.

Output Voltage Selector Guide

PART	V _{OUT} (V)	TOP MARK
MAX8532EBTJ	2.85	ACP
MAX8532EBTG	3	ACU
MAX8532EBT2	1.8	ACV

Note: Contact the factory for other output voltages between 1.5V and 3.3V. The minimum order quantity is 25,000 units.

Typical Operating Circuit

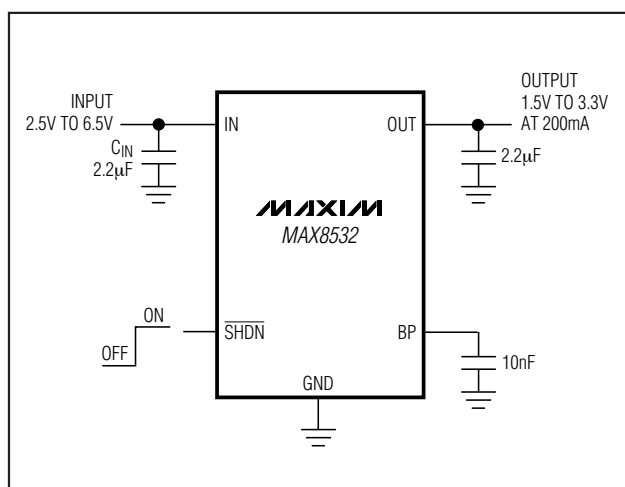

Bump Configuration

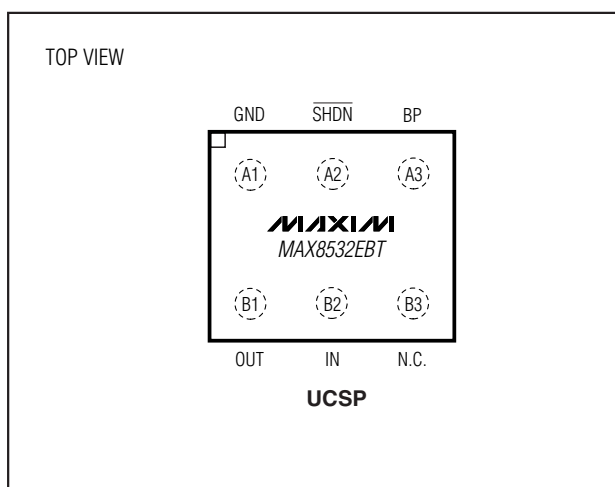

Low-Noise, Low-Dropout, 200mA Linear Regulator in UCSP

ABSOLUTE MAXIMUM RATINGS

IN, $\overline{\text{SHDN}}$, BP to GND	-0.3V to +7V	Junction Temperature	+150°C
OUT to GND	-0.3V to (VIN + 0.3V)	Storage Temperature Range	-65°C to +150°C
Output Short-Circuit Duration	Indefinite	6-Pin UCSP Solder Profile	(Note 1)
Continuous Power Dissipation (TA = +70°C)		Soldering Temperature (reflow)	
6-Pin UCSP (derate 3.9mW/°C above +70°C)	308mW	Lead(Pb)-Free Packages	+260°C
Operating Temperature Range	-40°C to +85°C	Packages Containing Lead(Pb)	+240°C

Note 1: For UCSP solder profile information, visit www.maxim-ic.com/1st_pages/UCSP.html.

Stresses beyond those listed under "Absolute Maximum Ratings" may cause permanent damage to the device. These are stress ratings only, and functional operation of the device at these or any other conditions beyond those indicated in the operational sections of the specifications is not implied. Exposure to absolute maximum rating conditions for extended periods may affect device reliability.

ELECTRICAL CHARACTERISTICS

(IN = 3.8V, $\overline{\text{SHDN}}$ = IN, C_{BP} = 10nF, TA = -40°C to +85°C, unless otherwise noted. Typical values are at TA = +25°C.) (Note 2)

PARAMETER	SYMBOL	CONDITIONS	MIN	TYP	MAX	UNITS
Input Voltage	V _{IN}		2.5		6.5	V
Undervoltage Lockout Threshold	V _{UVLO}	IN rising, hysteresis is 40mV (typ)	2.15	2.25	2.42	V
Output Voltage Accuracy		TA = +25°C, I _{OUT} = 1mA	-1		+1	%
		TA = -40°C to +85°C, I _{OUT} = 1mA	-2		+2	
		TA = -40°C to +85°C, I _{OUT} = 0.1mA to 200mA	-3		+3	
Maximum Output Current	I _{OUT}		200			mA
Current Limit	I _{LIM}		210	330	550	mA
Ground Current	I _Q	No load		80	150	µA
		I _{OUT} = 100mA		100		
Dropout Voltage	V _{OUT} - V _{IN}	I _{OUT} = 100mA (Note 3)		100	200	mV
Line Regulation	ΔV _{LNR}	IN = (V _{OUT} + 0.1V) to 3.8V	-0.2		+0.2	%/V
Output Voltage Noise		10Hz to 100kHz, C _{OUT} = 10µF, I _{OUT} = 10mA		40		µVRMS
Ripple Rejection	PSRR	100Hz, I _{OUT} = 30mA		62		dB
SHUTDOWN						
$\overline{\text{SHDN}}$ Supply Current	I _{OFF}	$\overline{\text{SHDN}}$ = 0, TA = +25°C		0.01	1	µA
		$\overline{\text{SHDN}}$ = 0, TA = +85°C		0.1		
$\overline{\text{SHDN}}$ Input Threshold	V _{IH}	Input high voltage	1.6			V
	V _{IL}	Input low voltage			0.4	
$\overline{\text{SHDN}}$ Input Bias Current	I _{SHDN}	$\overline{\text{SHDN}}$ = IN or GND	TA = +25°C	0.7	100	nA
			TA = +85°C	0.8		
THERMAL PROTECTION						
Thermal-Shutdown Temperature	T _{SHDN}	T _J rising		160		°C
Thermal-Shutdown Hysteresis	ΔT _{SHDN}			10		°C

Note 2: All units are 100% production tested at TA = +25°C. Limits over the operating temperature range are guaranteed by design.

Note 3: The dropout voltage is defined as V_{IN} - V_{OUT}, when V_{OUT} is 100mV below the value of V_{OUT} for V_{IN} = V_{OUT} + 0.5V. Specification applies only when V_{OUT} >= 2.5V.

Low-Noise, Low-Dropout, 200mA Linear Regulator in UCSP

Typical Operating Characteristics

MAX8532

($V_{OUT} = 2.85V$, load = 80mA, $V_{IN} = 3.8V$, $C_{OUT} = 2.2\mu F$, $C_{BP} = 0.01\mu F$, and $C_{IN} = 2.2\mu F$. $T_A = +25^\circ C$, unless otherwise noted.)

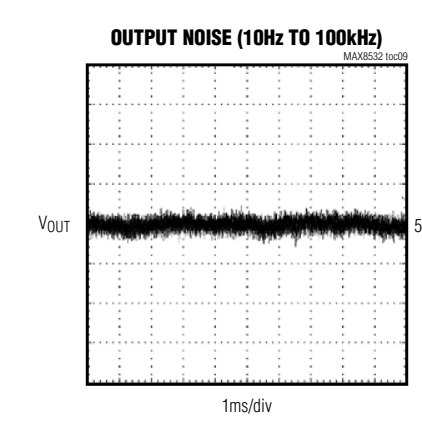
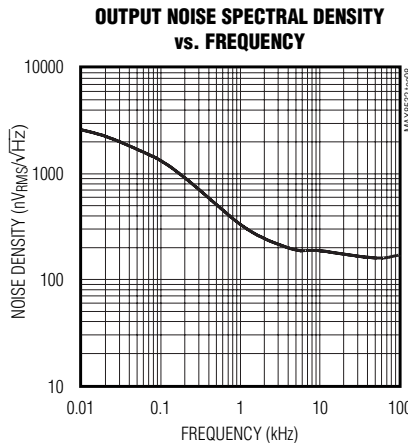
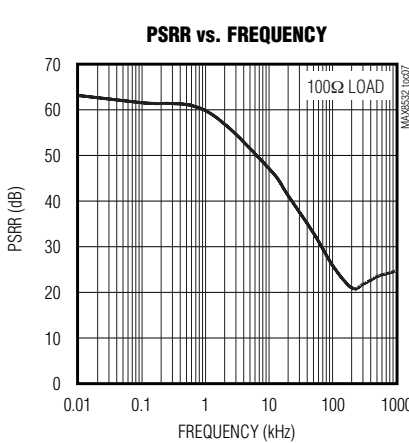
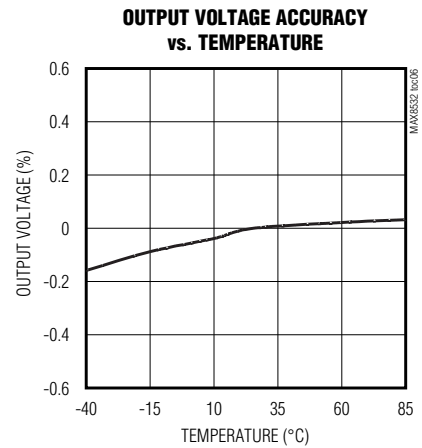
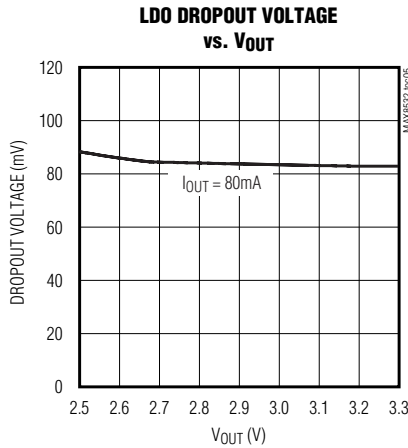
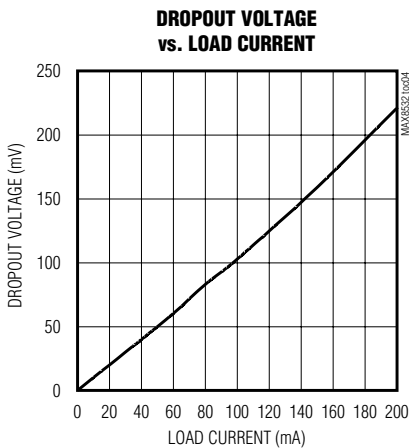
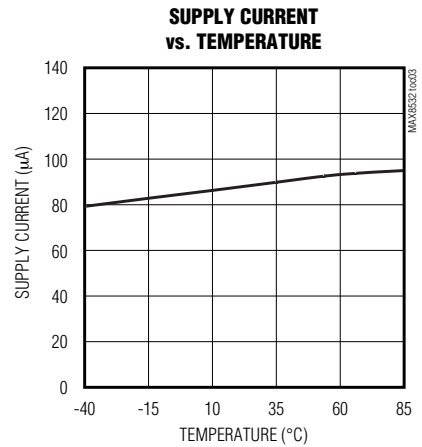
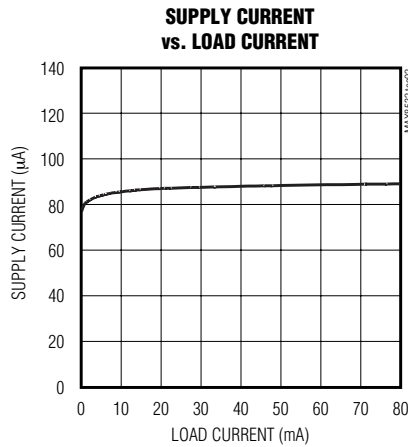
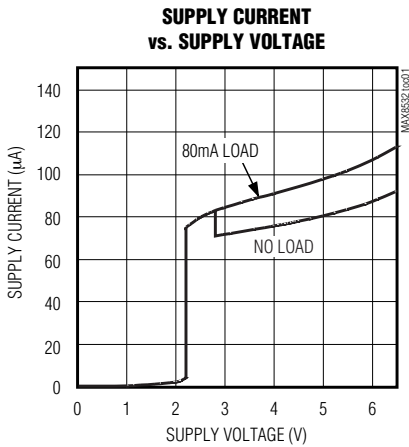

Low-Noise, Low-Dropout, 200mA Linear Regulator in UCSP

Typical Operating Characteristics (continued)

($V_{OUT} = 2.85V$, load = 80mA, $V_{IN} = 3.8V$, $C_{OUT} = 2.2\mu F$, $C_{BP} = 0.01\mu F$, and $C_{IN} = 2.2\mu F$. $T_A = +25^\circ C$, unless otherwise noted.)

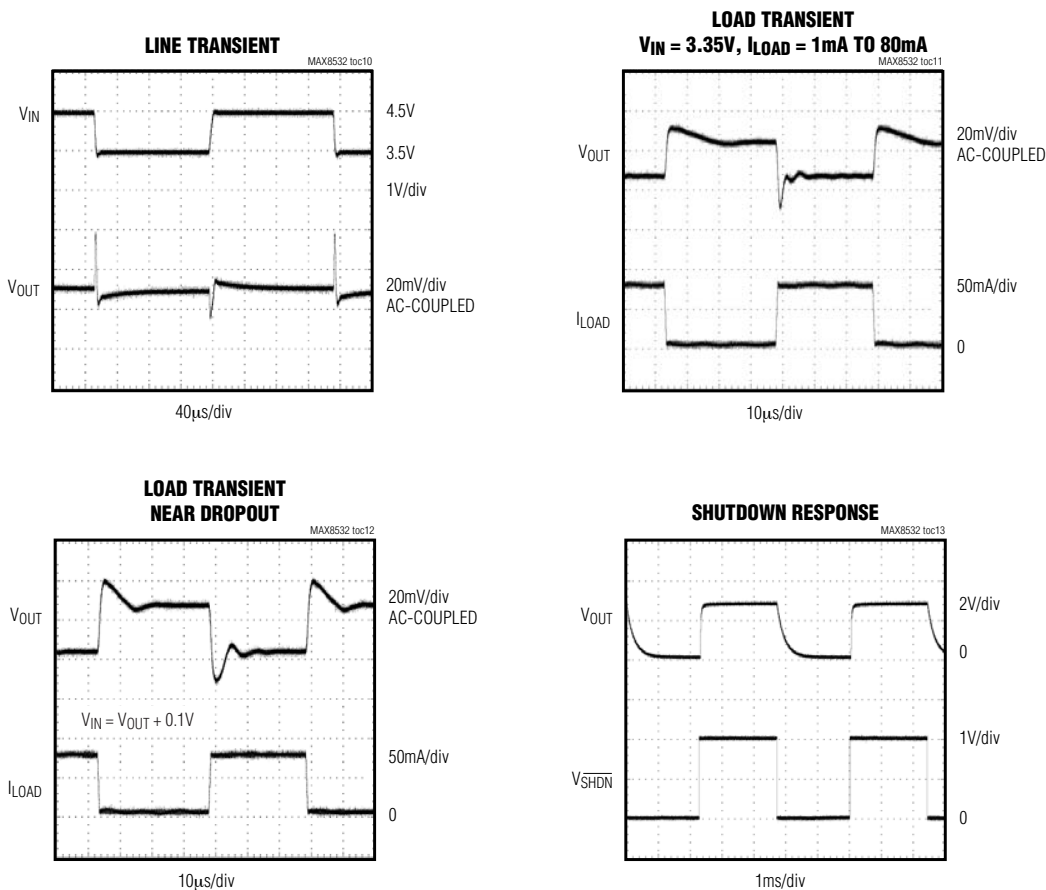

Bump Description

PIN	NAME	FUNCTION
B3	N.C.	Not Connected
B2	IN	Regulator Input
B1	OUT	Regulator Output. Guaranteed 200mA output current.
A1	GND	Ground
A2	\overline{SHDN}	Shutdown Input. A logic low shuts down the regulator. Connect to IN for normal operation.
A3	BP	Reference Noise Bypass. Bypass with a 0.01μF ceramic capacitor for reduced noise.

Low-Noise, Low-Dropout, 200mA Linear Regulator in UCSP

Functional Diagram

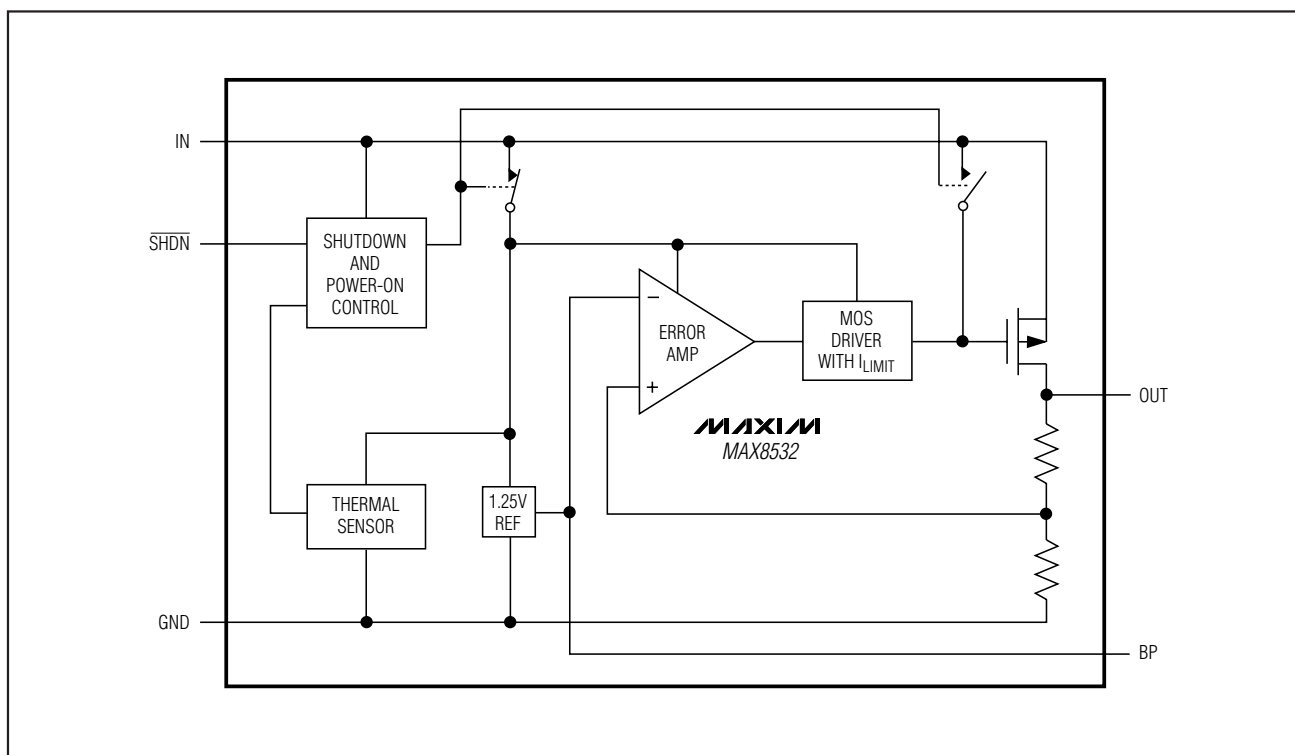

MAX8532

Detailed Description

The MAX8532 is a low-power, low-dropout, low-quiescent current linear regulator designed primarily for battery-powered applications. For preset output voltages, see the *Output Voltage Selector Guide*. The device supplies up to 200mA for OUT. The MAX8532 consists of a 1.25V reference, error amplifier, P-channel pass transistor, reference bypass block, and internal feedback voltage divider.

The 1.25V bandgap reference is connected to the error amplifier's inverting input. The error amplifier compares this reference with the feedback voltage and amplifies the difference. If the feedback voltage is lower than the reference voltage, allowing more current to pass to the output and increasing the output voltage. If the feedback voltage is high, the pass-transistor gate is pulled up, allowing less current to pass to the output. The output voltage is fed back through an internal resistor voltage-divider connected to the OUT pin.

Shutdown

The MAX8532 has a single shutdown control input (SHDN). Drive SHDN low to shut down the output, reducing supply current to 10nA. Connect SHDN to a logic-high, or IN, for normal operation.

Internal P-Channel Pass Transistor

The MAX8532 features a 1Ω P-channel MOSFET pass transistor. A P-channel MOSFET provides several advantages over similar designs using PNP pass transistors, including longer battery life. It requires no base drive, reducing quiescent current. PNP-based regulators waste considerable current in dropout when the pass transistor saturates and also use high base-drive currents under heavy loads. The MAX8532 does not suffer these problems and consumes only 90μA quiescent current whether in dropout, light-load, or heavy-load applications (see the *Typical Operating Characteristics*). Whereas a PNP-based regulator has dropout voltage independent of the load, a P-channel MOSFET's dropout voltage is proportional to load current, providing for low dropout voltage at heavy loads and extremely low dropout voltage at lighter loads.

Low-Noise, Low-Dropout, 200mA Linear Regulator in UCSP

Current Limit

The MAX8532 contains an independent current limiter, which monitors and controls the pass transistor's gate voltage, limiting the output current to 210mA (min). The output can be shorted to ground indefinitely without damaging the part.

Thermal-Overload Protection

Thermal-overload protection limits total power dissipation in the MAX8532. When the junction temperature exceeds $T_J = +160^\circ\text{C}$, the thermal sensor signals the shutdown logic, turning off the pass transistor and allowing the IC to cool. The thermal sensor turns the pass transistor on again after the IC's junction temperature cools by 10°C , resulting in a pulsed output during continuous thermal-overload conditions.

Thermal-overload protection is designed to protect the MAX8532 in the event of fault conditions. For continual operation, do not exceed the absolute maximum junction temperature rating of $T_J = +150^\circ\text{C}$.

Operating Region and Power Dissipation

The MAX8532's maximum power dissipation depends on the thermal resistance of the case and circuit board, the temperature difference between the die junction and ambient air, and the airflow rate. The power dissipation across the device is $P = I_{OUT}(V_{IN} - V_{OUT})$. Maximum power dissipation:

$$P_{MAX} = (T_J - T_A)/(\theta_{JB} + \theta_{BA})$$

where $T_J - T_A$ is the temperature difference between the MAX8532 die junction and the surrounding air, θ_{JB} (or θ_{JC}) is the thermal resistance of the package, and θ_{BA} is the thermal resistance through the printed circuit board, copper traces, and other materials, to the surrounding air.

Low-Noise Operation

An external $0.01\mu\text{F}$ bypass capacitor at BP, in conjunction with an internal resistor, creates a lowpass filter. The MAX8532 exhibits $40\mu\text{V}_{RMS}$ output voltage noise with $C_{BP} = 0.01\mu\text{F}$ and $C_{OUT} = 2.2\mu\text{F}$ (see the Output Noise Spectral Density vs. Frequency graph in the *Typical Operating Characteristics*).

Applications Information

Capacitor Selection and Regulator Stability

Use a $2.2\mu\text{F}$ capacitor on the MAX8532's input. Larger input capacitor values with lower ESR provide better supply-noise rejection and line-transient response. To reduce noise and improve load transients, use large output capacitors up to $10\mu\text{F}$. For stable operation over the full temperature range and with rated maximum load currents, use a minimum of $2.2\mu\text{F}$ (or $1\mu\text{F}$ for $<150\text{mA}$ loading) for OUT.

Note that some ceramic dielectrics exhibit large capacitance and ESR variation with temperature. With dielectrics such as Z5U and Y5V, use $4.7\mu\text{F}$ or more to ensure stability at temperatures below -10°C . With X7R or X5R dielectrics, $2.2\mu\text{F}$ is sufficient at all operating temperatures. These regulators are optimized for ceramic capacitors. Tantalum capacitors are not recommended.

PSRR and Operation from Sources Other than Batteries

The MAX8532 is designed to deliver low dropout voltages and low quiescent currents in battery-powered systems. Power-supply rejection is 62dB at low frequencies (see the Power-Supply Rejection Ratio vs. Frequency graph in the *Typical Operating Characteristics*).

When operating from sources other than batteries, improve supply-noise rejection and transient response by increasing the values of the input and output bypass capacitors and through passive filtering techniques.

Low-Noise, Low-Dropout, 200mA Linear Regulator in UCSP

Load-Transient Considerations

The MAX8532 load-transient response graphs (see the *Typical Operating Characteristics*) show two components of the output response: a DC shift in the output voltage due to the different load currents, and the transient response. Increase the output capacitor's value and decrease its ESR to attenuate transient spikes.

Input/Output (Dropout Voltage)

A regulator's minimum input/output voltage differential (or dropout voltage) determines the lowest usable supply voltage. In battery-powered systems, this determines the useful end-of-life battery voltage. Because the MAX8532 uses a P-channel MOSFET pass transistor, its dropout voltage is a function of drain-to-source on-resistance ($R_{DS(ON)}$) multiplied by the load current (see the *Typical Operating Characteristics*).

Calculating the Maximum Output Power in UCSP

The maximum output power of the MAX8532 can be limited by the maximum power dissipation of the package. Ascertain the maximum power dissipation by calculating the power dissipation of the package as a function of the input voltage, output voltage, and output current. The maximum power dissipation should not exceed the package's maximum power rating:

$$P = (V_{IN(MAX)} - V_{OUT}) \times I_{OUT}$$

where:

$V_{IN(MAX)}$ = Maximum input voltage

P_{MAX} = Maximum power dissipation of the package (308mW for UCSP)

V_{OUT} = Output voltage of OUT

I_{OUT} = Maximum output current of OUT

P should be less than P_{MAX} .

Chip Information

PROCESS: BiCMOS

Package Information

For the latest package outline information and land patterns (footprints), go to www.maxim-ic.com/packages. Note that a "+", "#", or "-" in the package code indicates RoHS status only. Package drawings may show a different suffix character, but the drawing pertains to the package regardless of RoHS status.

PACKAGE TYPE	PACKAGE CODE	OUTLINE NO.	LAND PATTERN NO.
6 UCSP	B6-6	21-0097	—

Low-Noise, Low-Dropout, 200mA Linear Regulator in UCSP

Revision History

REVISION NUMBER	REVISION DATE	DESCRIPTION	PAGES CHANGED
0	3/07	Initial release	—
1	2/12	Added MAX8532EBT2 to <i>Ordering Information</i> , updated lead-free and soldering information	1, 2

Maxim cannot assume responsibility for use of any circuitry other than circuitry entirely embodied in a Maxim product. No circuit patent licenses are implied. Maxim reserves the right to change the circuitry and specifications without notice at any time. The parametric values (min and max limits) shown in the Electrical Characteristics table are guaranteed. Other parametric values quoted in this data sheet are provided for guidance.

8 **Maxim Integrated Products, 120 San Gabriel Drive, Sunnyvale, CA 94086 408-737-7600**