

Excellent Integrated System Limited

Stocking Distributor

Click to view price, real time Inventory, Delivery & Lifecycle Information:

[Intersil](#)
[ISL28274FAZ](#)

For any questions, you can email us directly:
sales@integrated-circuit.com

Micropower, Single Supply, Rail-to-Rail Input-Output Instrumentation Amplifier and Precision Operational Amplifier

The ISL28274 is a combination of a micropower instrumentation amplifier (Amp A) with a low power precision amplifier (Amp B) in a single package. The ISL28474 consists of two micropower instrumentation amplifiers (Amp A) and two low power precision amplifiers (Amp B) in a single package. The amplifiers are optimized for operation at 2.4V to 5V single supplies. Inputs and outputs can operate rail-to-rail. As with all instrumentation amplifiers, a pair of inputs provide a high common-mode rejection and are completely independent from a pair of feedback terminals. The feedback terminals allow zero input to be translated to any output offset, including ground. A feedback divider controls the overall gain of the amplifier. The additional precision amplifier can be used to generate higher gain, with smaller feedback resistors or used to generate a reference voltage.

The instrumentation amp (Amp A) is compensated for a gain of 100 or more and the precision amp (Amp B) is unity gain stable. Both amplifiers have PMOS inputs that provide less than 30pA input bias currents.

The amplifiers can be operated from one lithium cell or two Ni-Cd batteries. The amplifiers input range goes from below ground to slightly above positive rail. The output stage swings completely to ground or positive supply; no pull-up or pull-down resistors are needed.

Ordering Information

PART NUMBER (Note)	PART MARKING	PACKAGE (Pb-Free)	PKG. DWG. #
ISL28274FAZ*	28274 FAZ	16 Ld QSOP	MDP0040
ISL28474FAZ*	ISL28474 FAZ	24 Ld QSOP	MDP0040

*Add "-T7" suffix for tape and reel. Please refer to TB347 for details on reel specifications

NOTE: These Intersil Pb-free plastic packaged products employ special Pb-free material sets, molding compounds/die attach materials, and 100% matte tin plate plus anneal (e3 termination finish, which is RoHS compliant and compatible with both SnPb and Pb-free soldering operations). Intersil Pb-free products are MSL classified at Pb-free peak reflow temperatures that meet or exceed the Pb-free requirements of IPC/JEDEC J STD-020.

Features

- Combination of IN-AMP and OP-AMP in a Single Package
- 120µA Supply Current for ISL28274
- Input Offset Voltage IN-AMP 500µV Max
- Input Offset Voltage OP-AMP 225µV Max
- 30pA Max Input Bias Current
- 100dB CMRR and PSRR
- Single Supply Operation of 2.4V to 5.0V
- Ground Sensing
- Input Voltage Range is Rail-to-Rail and Output Swings Rail-to-Rail
- Pb-Free available (RoHS Compliant)

Applications

- 4mA to 20mA Loops
- Industrial Process Control
- Medical Instrumentation

ISL28274, ISL28474

Pinout

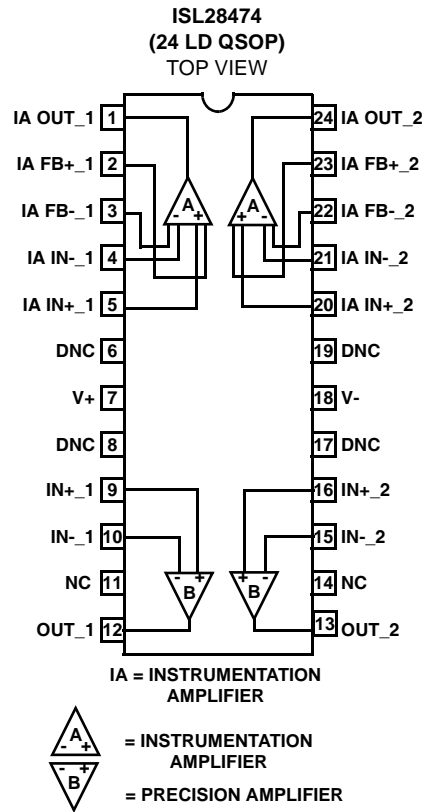
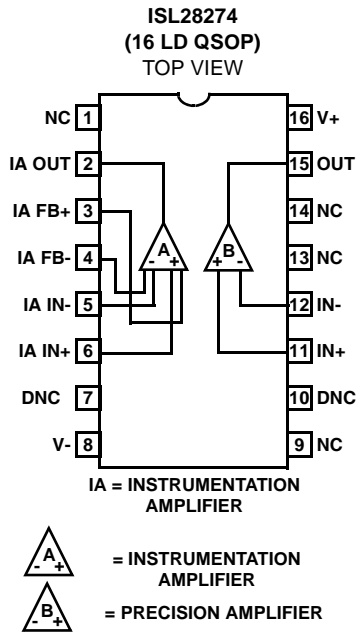

ISL28274, ISL28474

Absolute Maximum Ratings (T_A = +25°C)

Supply Voltage	5.5V
Supply Turn-On Voltage Slew Rate	1V/μs
Input Current (IN, FB)	5mA
Differential Input Voltage (IN, FB)	0.5V
Input Voltage	V ₋ - 0.5V to V ₊ + 0.5V
ESD Rating	
Human Body Model	3kV
Machine Model	300V

Thermal Information

Thermal Resistance (Typical Note 1)	θ _{JA} (°C/W)
16 Ld QSOP Package	112
24 Ld QSOP Package	88
Output Short-Circuit Duration	Indefinite
Ambient Operating Temperature Range	-40°C to +125°C
Storage Temperature Range	-65°C to +150°C
Operating Junction Temperature	+125°C
Pb-Free Reflow Profile	see link below
	http://www.intersil.com/pbfree/Pb-FreeReflow.asp

CAUTION: Do not operate at or near the maximum ratings listed for extended periods of time. Exposure to such conditions may adversely impact product reliability and result in failures not covered by warranty.

NOTES:

1. θ_{JA} is measured with the component mounted on a high effective thermal conductivity test board in free air. See Tech Brief TB379 for details.

IMPORTANT NOTE: All parameters having Min/Max specifications are guaranteed. Typical values are for information purposes only. Unless otherwise noted, all tests are at the specified temperature and are pulsed tests, therefore: T_J = T_C = T_A

Electrical Specifications **INSTRUMENTATION AMPLIFIER "A"** V₊ = +5V, V₋ = GND, V_{CM} = 1/2V₊, T_A = +25°C, unless otherwise specified. For ISL28274 ONLY. Boldface limits apply over the operating temperature range, -40°C to +125°C, temperature data established by characterization.

PARAMETER	DESCRIPTION	CONDITIONS	MIN (Note 2)	TYP	MAX (Note 2)	UNIT	
V _{OS}	Input Offset Voltage	ISL28274	-400 -750	35	400 750	μV	
		ISL28474	-500 -750	35	500 750	μV	
TCV _{OS}	Input Offset Voltage Temperature Coefficient	Temperature = -40°C to +125°C		3		μV/°C	
I _{OS}	Input Offset Current between IN+ and IN-, and between FB+ and FB-	(see Figure 43 for extended temperature range) -40°C to +85°C	-30 -80	±5	30 80	pA	
I _B	Input Bias Current (IN+, IN-, FB+, and FB- terminals)	(see Figures 35 and 36 for extended temperature range) -40°C to +85°C	-30 -80	±10	30 80	pA	
e _N	Input Noise Voltage	f = 0.1Hz to 10Hz		6		μV _{P-P}	
	Input Noise Voltage Density	f ₀ = 1kHz		78		nV/√Hz	
i _N	Input Noise Current Density	f ₀ = 1kHz		0.19		pA/√Hz	
R _{IN}	Input Resistance			1		GΩ	
V _{IN}	Input Voltage Range	V ₊ = 2.4V to 5.0V	0		V ₊	V	
CMRR	Common Mode Rejection Ratio	V _{CM} = 0V to 5V	80 75	100		dB	
PSRR	Power Supply Rejection Ratio	V ₊ = 2.4V to 5V	80 75	100		dB	
E _G	Gain Error	R _L = 100kΩ to 2.5V		-0.2		%	
SR	Slew Rate	R _L = 1kΩ to V _{CM}	ISL28274	0.40 0.35	0.5	0.65 0.70	V/μs
			ISL28474	0.40 0.35	0.5	0.7 0.75	V/μs
GBWP	Gain Bandwidth Product	V _{OUT} = 10mV _{P-P} ; R _L = 10kΩ		6		MHz	

ISL28274, ISL28474

Electrical Specifications OPERATIONAL AMPLIFIER "B" $V_+ = +5V$, $V_- = GND$, $V_{CM} = 1/2V_+$, $T_A = +25^\circ C$, unless otherwise specified. For ISL28274 ONLY. Boldface limits apply over the operating temperature range, $-40^\circ C$ to $+125^\circ C$.

PARAMETER	DESCRIPTION	CONDITIONS	MIN (Note 2)	TYP	MAX (Note 2)	UNIT
V_{OS}	Input Offset Voltage		-225 -450	± 20	225 450	μV
$\frac{\Delta V_{OS}}{\Delta Time}$	Long Term Input Offset Voltage Stability			1.2		$\mu V/Mo$
$\frac{\Delta V_{OS}}{\Delta T}$	Input Offset Drift vs Temperature			2.2		$\mu V/^\circ C$
I_{OS}	Input Offset Current	(see Figure 45 for extended temperature range) $-40^\circ C$ to $+85^\circ C$	-30 -80	± 5	30 80	pA
I_B	Input Bias Current	(see Figures 39 and 40 for extended temperature range) $-40^\circ C$ to $+85^\circ C$	-30 -80	± 10	30 80	pA
e_N	Input Noise Voltage Peak-to-Peak	$f = 0.1Hz$ to $10Hz$		5.4		μV_{P-P}
	Input Noise Voltage Density	$f_0 = 1kHz$		50		nV/\sqrt{Hz}
i_N	Input Noise Current Density	$f_0 = 1kHz$		0.14		pA/\sqrt{Hz}
CMIR	Input Voltage Range	Guaranteed by CMRR test	0		5	V
CMRR	Common-Mode Rejection Ratio	$V_{CM} = 0V$ to $5V$	80 75	100		dB
PSRR	Power Supply Rejection Ratio	$V_+ = 2.4V$ to $5V$	85 80	105		dB
A_{VOL}	Large Signal Voltage Gain	$V_O = 0.5V$ to $4.5V$, $R_L = 100k\Omega$	200 190	300		V/mV
SR	Slew Rate	$R_L = 1k\Omega$ to V_{CM}	0.12 0.09	± 0.14	0.16 0.21	V/ μs
GBW	Gain Bandwidth Product	$V_{OUT} = 10mV_{P-P}$; $R_L = 10k\Omega$		300		kHz

Electrical Specifications COMMON ELECTRICAL SPECIFICATIONS $V_+ = 5V$, $V_- = GND$, $V_{CM} = 1/2V_+$, $T_A = +25^\circ C$, unless otherwise specified. For ISL28274 ONLY. Boldface limits apply over the operating temperature range, $-40^\circ C$ to $+125^\circ C$.

PARAMETER	DESCRIPTION	CONDITIONS	MIN (Note 2)	TYP	MAX (Note 2)	UNIT
V_{OUT}	Maximum Output Voltage Swing	Output low, $R_L = 100k\Omega$ to V_{CM}		3	6 30	mV
		Output low, $R_L = 1k\Omega$ to V_{CM}		130	175 225	mV
		Output high, $R_L = 100k\Omega$ to V_{CM}	4.990 4.97	4.996		V
		Output high, $R_L = 1k\Omega$ to V_{CM}	4.800 4.750	4.880		V
$I_{S,ON}$	Supply Current	ISL28274 All channels		120	156 175	μA
		ISL28474 All channels		240	315 350	μA
I_{SC+}	Short Circuit Sourcing Capability	$R_L = 10\Omega$ to V_{CM}	28 24	31		mA
I_{SC-}	Short Circuit Sinking Capability	$R_L = 10\Omega$ to V_{CM}	24 20	26		mA
V_+	Minimum Supply Voltage		2.4			V

NOTE:

- Parts are 100% tested at $+25^\circ C$. Over temperature limits established by characterization and are not production tested.

ISL28274, ISL28474

Typical Performance Curves $V_+ = +5V$, $V_- = GND$, $V_{CM} = 1/2V_+$, $T_A = +25^\circ C$, unless otherwise specified.

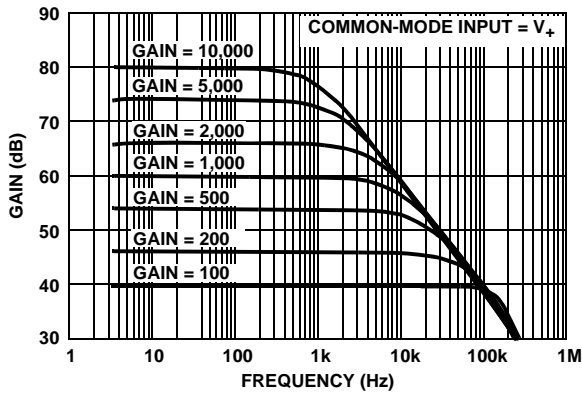

FIGURE 1. AMPLIFIER "A" (IN-AMP) FREQUENCY RESPONSE vs CLOSED LOOP GAIN

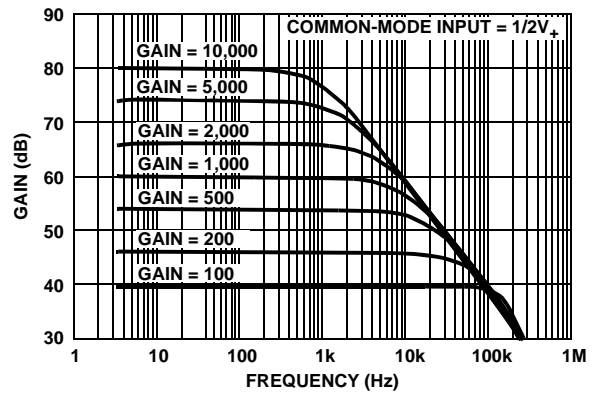

FIGURE 2. AMPLIFIER "A" (IN-AMP) FREQUENCY RESPONSE vs CLOSED LOOP GAIN, $V_{CM} = 1/2V_+$

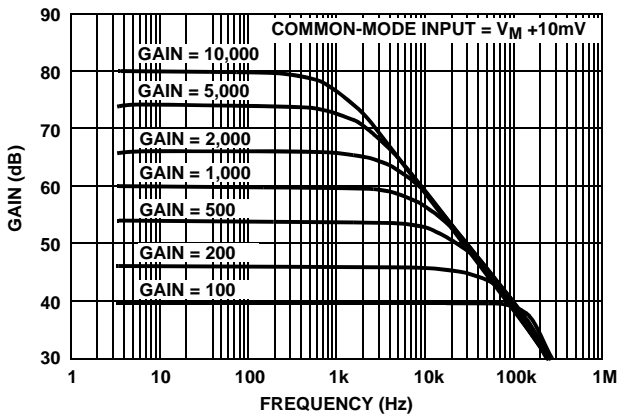

FIGURE 3. AMPLIFIER "A" (IN-AMP) FREQUENCY RESPONSE vs CLOSED LOOP GAIN

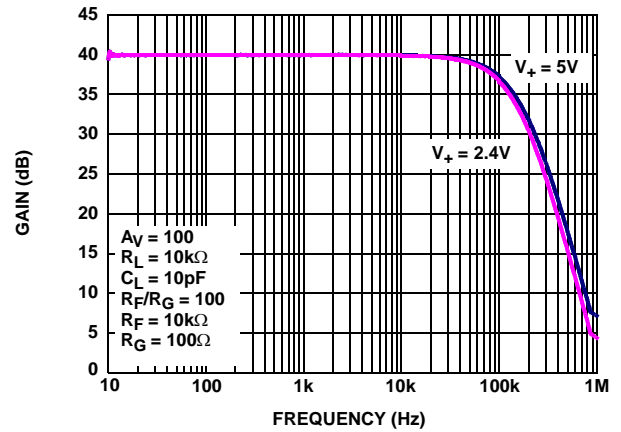

FIGURE 4. AMPLIFIER "A" (IN-AMP) FREQUENCY RESPONSE vs SUPPLY VOLTAGE

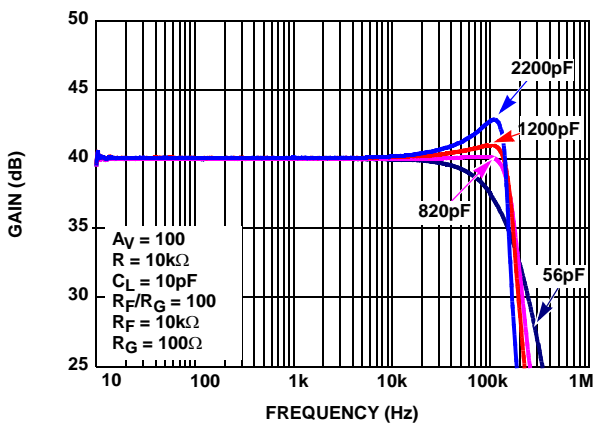

FIGURE 5. AMPLIFIER "A" (IN-AMP) FREQUENCY RESPONSE vs C_{LOAD}

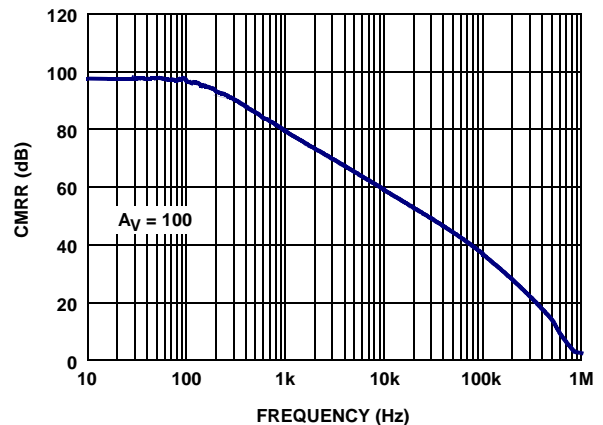

FIGURE 6. AMPLIFIER "A" (IN-AMP) CMRR vs FREQUENCY

ISL28274, ISL28474

Typical Performance Curves $V_+ = +5V, V_- = GND, V_{CM} = 1/2V_+, T_A = +25^\circ C$, unless otherwise specified. (Continued)

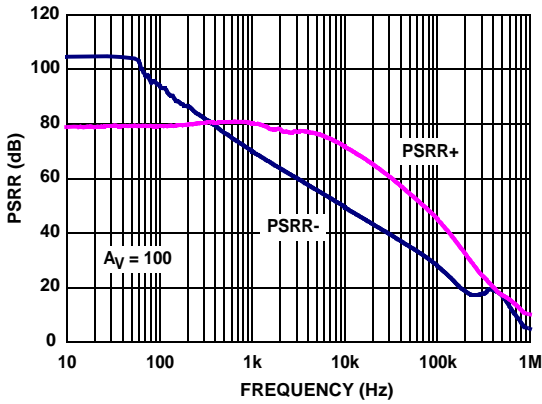

FIGURE 7. AMPLIFIER "A" (IN-AMP) PSRR vs FREQUENCY

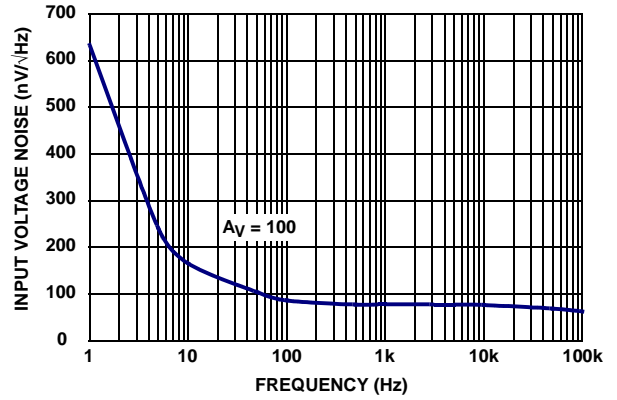

FIGURE 8. AMPLIFIER "A" (IN-AMP) INPUT VOLTAGE NOISE SPECTRAL DENSITY

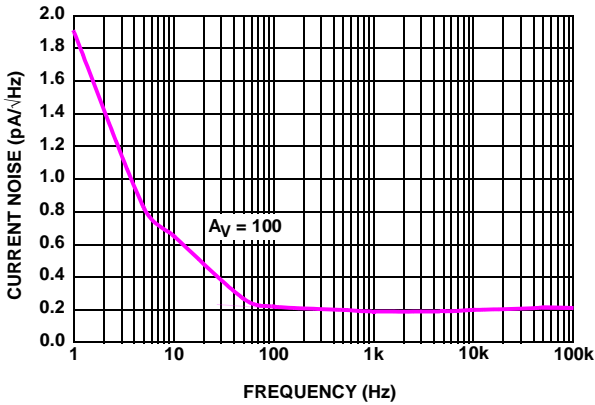

FIGURE 9. AMPLIFIER "A" (IN-AMP) INPUT CURRENT NOISE SPECTRAL DENSITY

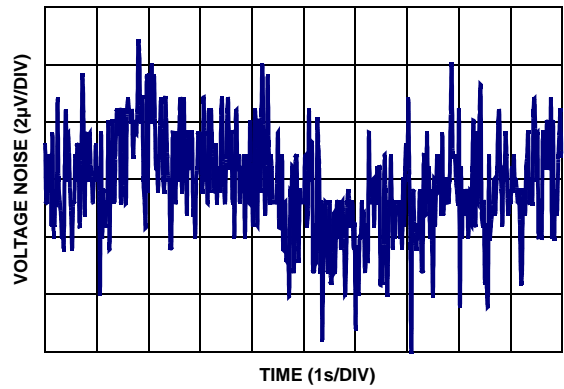

FIGURE 10. AMPLIFIER "A" (IN-AMP) 0.1Hz TO 10Hz INPUT VOLTAGE NOISE

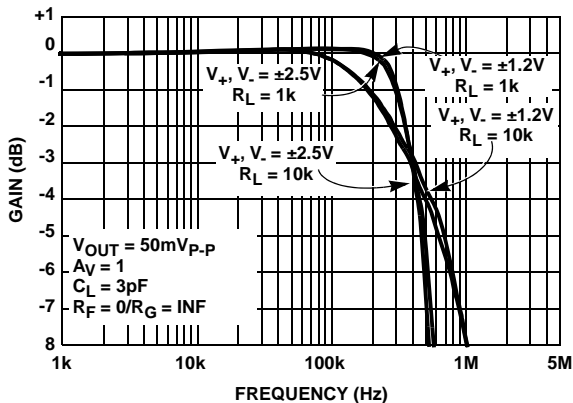

FIGURE 11. AMPLIFIER "B" (OP-AMP) FREQUENCY RESPONSE vs SUPPLY VOLTAGE

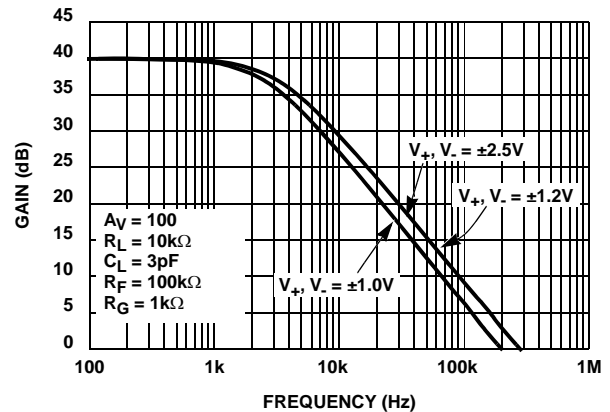

FIGURE 12. AMPLIFIER "B" (OP-AMP) FREQUENCY RESPONSE vs SUPPLY VOLTAGE

ISL28274, ISL28474

Typical Performance Curves $V_+ = +5V, V_- = GND, V_{CM} = 1/2V_+, T_A = +25^\circ C$, unless otherwise specified. (Continued)

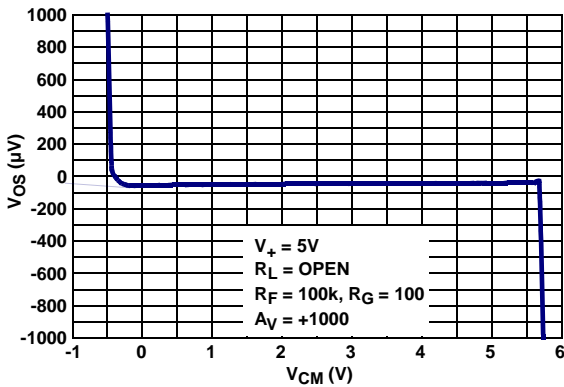

FIGURE 13. INPUT OFFSET VOLTAGE vs COMMON MODE INPUT VOLTAGE

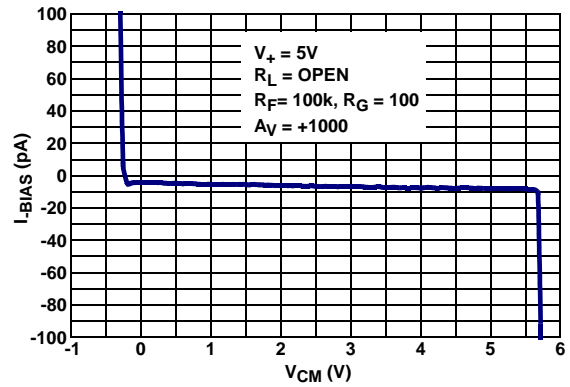

FIGURE 14. INPUT BIAS CURRENT vs COMMON-MODE INPUT VOLTAGE

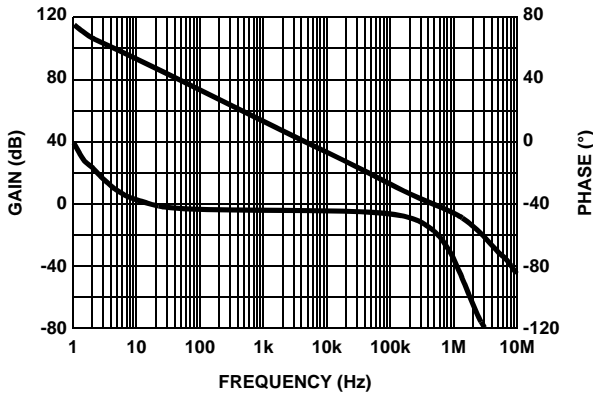

FIGURE 15. AMPLIFIER "B" (OP AMP) A_{VOL} vs FREQUENCY @ 100k Ω LOAD

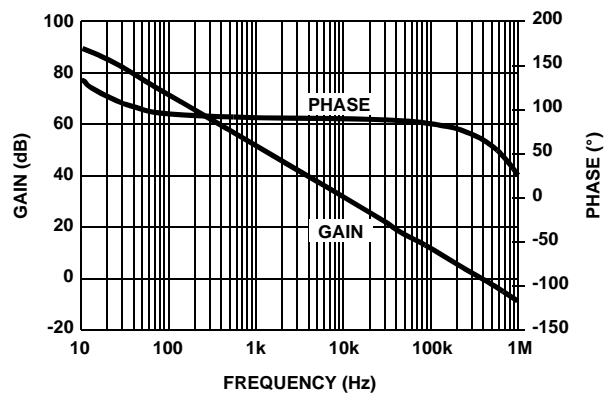

FIGURE 16. AMPLIFIER "B" (OP AMP) A_{VOL} vs FREQUENCY @ 1k Ω LOAD

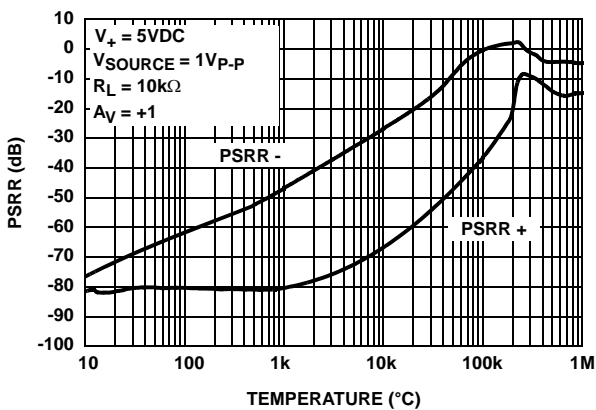

FIGURE 17. AMPLIFIER "B" (OP AMP) PSRR vs FREQUENCY

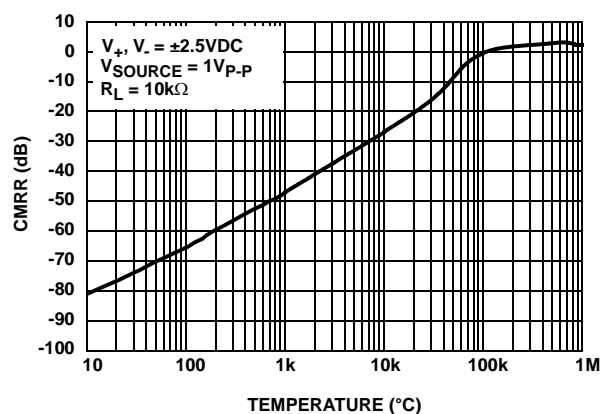

FIGURE 18. AMPLIFIER "B" (OP AMP) CMRR vs FREQUENCY

ISL28274, ISL28474

Typical Performance Curves $V_+ = +5V$, $V_- = GND$, $V_{CM} = 1/2V_+$, $T_A = +25^\circ C$, unless otherwise specified. (Continued)

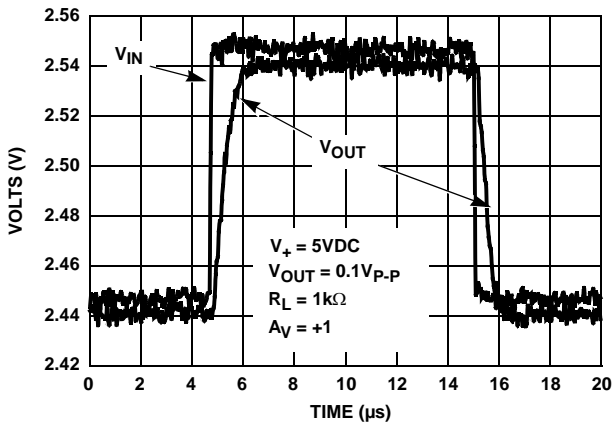

FIGURE 19. AMPLIFIER "B" (OP AMP) SMALL SIGNAL TRANSIENT RESPONSE

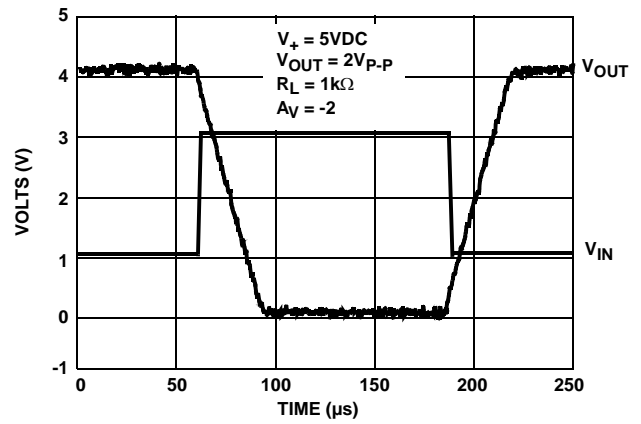

FIGURE 20. AMPLIFIER "B" (OP AMP) LARGE SIGNAL TRANSIENT RESPONSE

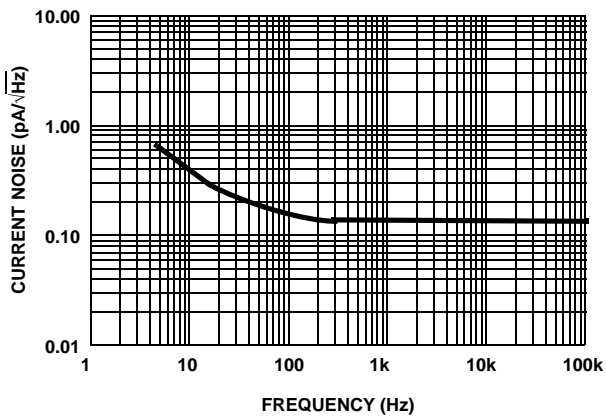

FIGURE 21. AMPLIFIER "B" (OP AMP) CURRENT NOISE vs FREQUENCY

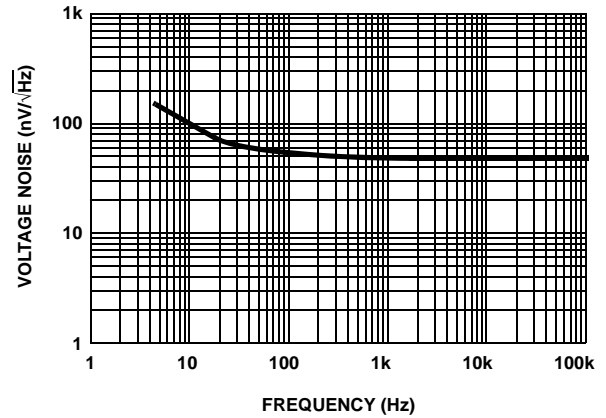

FIGURE 22. AMPLIFIER "B" (OP AMP) VOLTAGE NOISE vs FREQUENCY

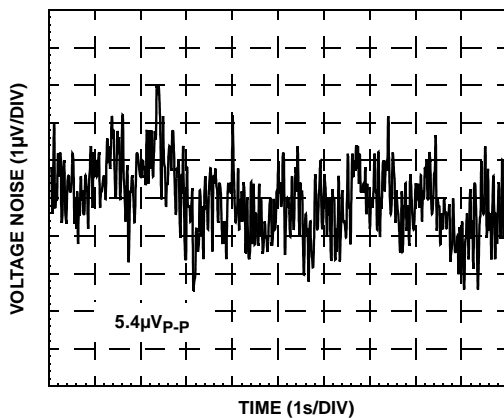

FIGURE 23. AMPLIFIER "B" (OP AMP) 0.1Hz TO 10Hz INPUT VOLTAGE NOISE

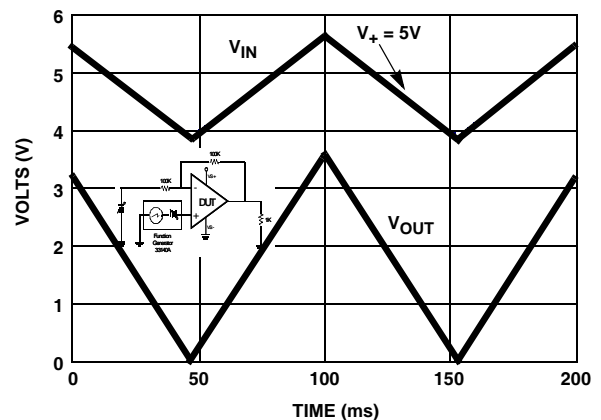

FIGURE 24. AMPLIFIER "B" (OP AMP) INPUT VOLTAGE SWING ABOVE THE V_+ SUPPLY

ISL28274, ISL28474

Typical Performance Curves $V_+ = +5V, V_- = GND, V_{CM} = 1/2V_+, T_A = +25^\circ C$, unless otherwise specified. (Continued)

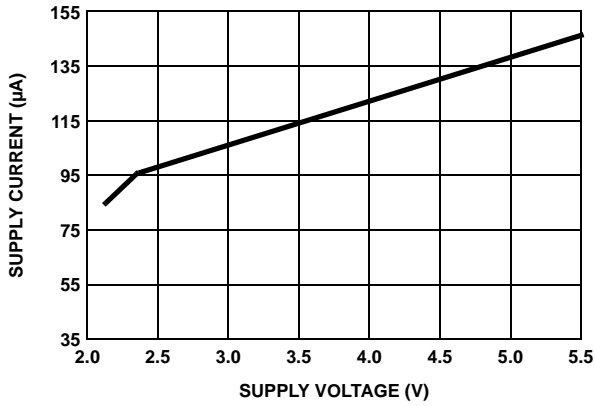

FIGURE 25. SUPPLY CURRENT vs SUPPLY VOLTAGE

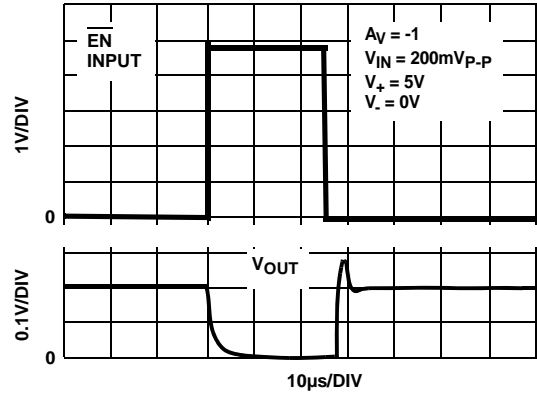

FIGURE 26. AMPLIFIER "B" (OP AMP) TO OUTPUT DELAY TIME

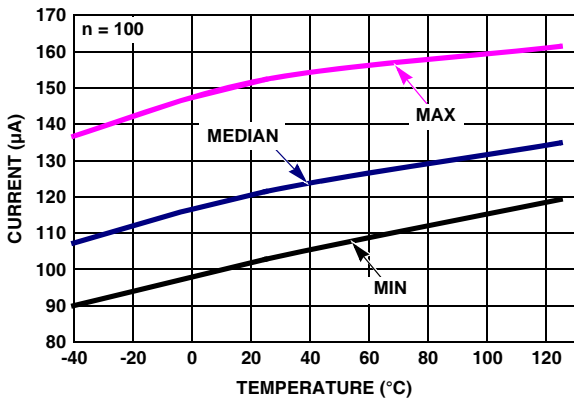

FIGURE 27. TOTAL SUPPLY CURRENT vs TEMPERATURE, $V_+, V_- = \pm 2.5V, R_L = INF$

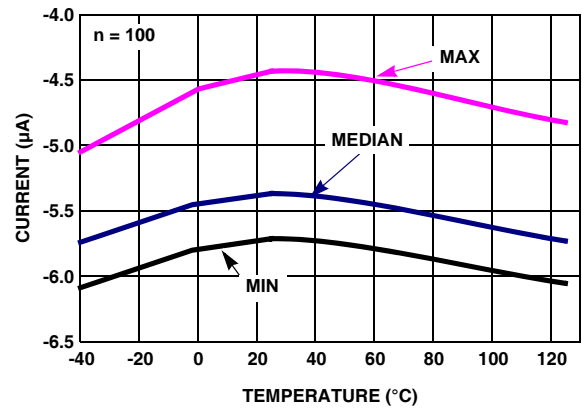

FIGURE 28. DISABLED NEGATIVE SUPPLY CURRENT vs TEMPERATURE, $V_+, V_- = \pm 2.5V, R_L = INF$

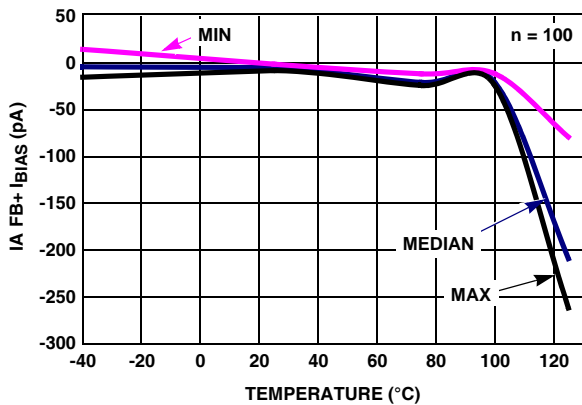

FIGURE 29. I_{BIAS} (IA FB+) vs TEMPERATURE, $V_+, V_- = \pm 2.5V$

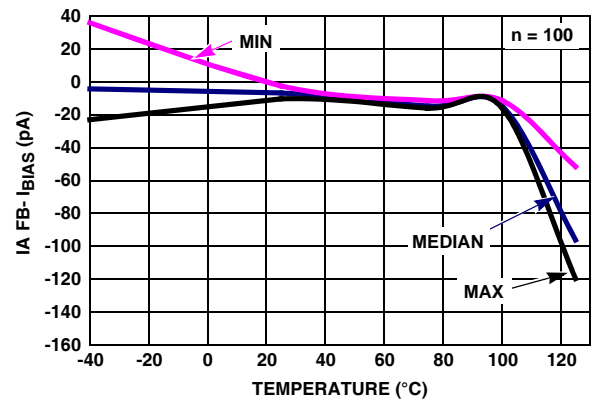

FIGURE 30. I_{BIAS} (IA FB-) vs TEMPERATURE, $V_+, V_- = \pm 2.5V$.

ISL28274, ISL28474

Typical Performance Curves $V_+ = +5V, V_- = GND, V_{CM} = 1/2V_+, T_A = +25^\circ C$, unless otherwise specified. (Continued)

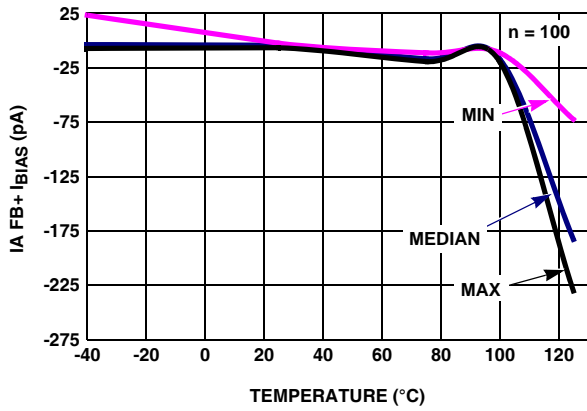

FIGURE 31. I_{BIAS} (IA FB+) vs TEMPERATURE, $V_+, V_- = \pm 1.2V$

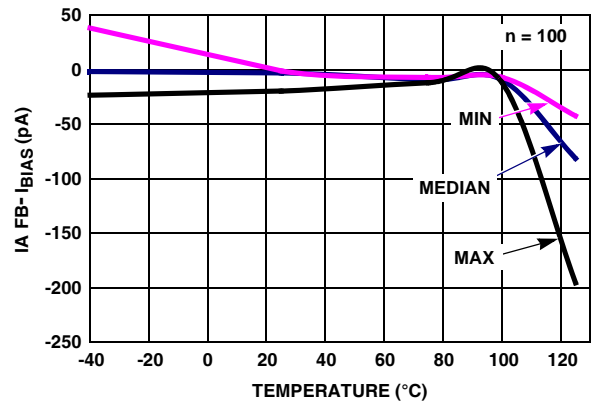

FIGURE 32. I_{BIAS} (IA FB-) vs TEMPERATURE, $V_+, V_- = \pm 1.2V$

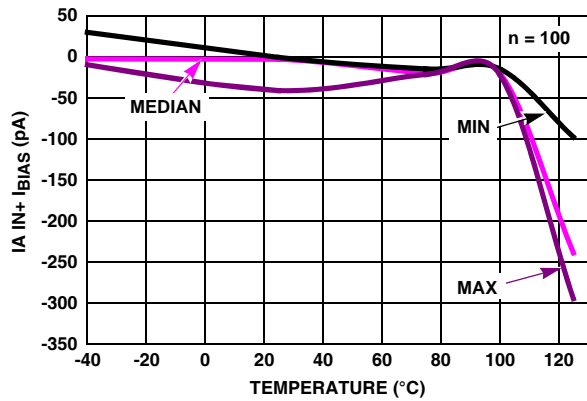

FIGURE 33. I_{BIAS} (IA IN+) vs TEMPERATURE, $V_+, V_- = \pm 2.5V$

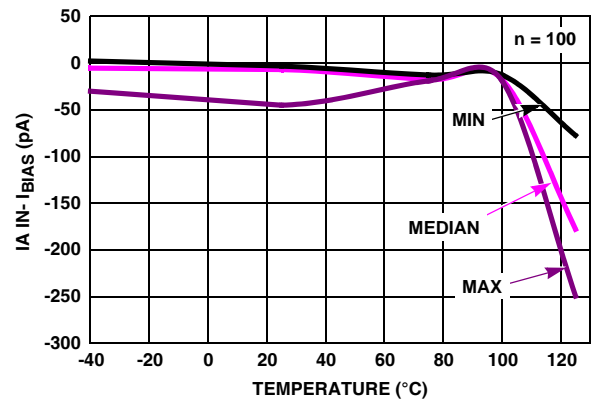

FIGURE 34. I_{BIAS} (IA IN-) vs TEMPERATURE, $V_+, V_- = \pm 2.5V$

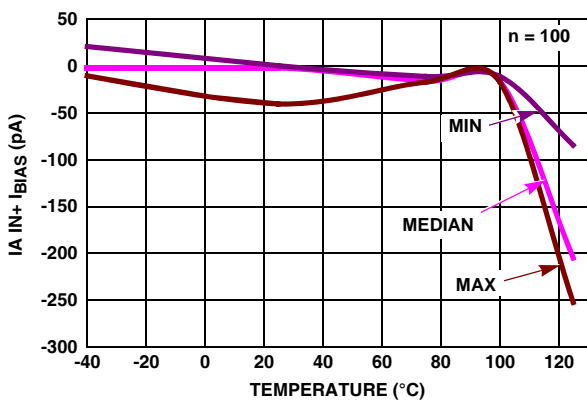

FIGURE 35. I_{BIAS} (IA IN+) vs TEMPERATURE, $V_+, V_- = \pm 1.2V$

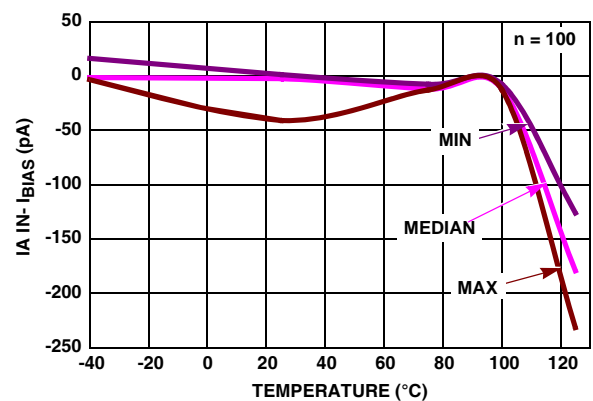

FIGURE 36. I_{BIAS} (IA IN-) vs TEMPERATURE, $V_+, V_- = \pm 1.2V$

ISL28274, ISL28474

Typical Performance Curves $V_+ = +5V, V_- = GND, V_{CM} = 1/2V_+, T_A = +25^\circ C$, unless otherwise specified. (Continued)

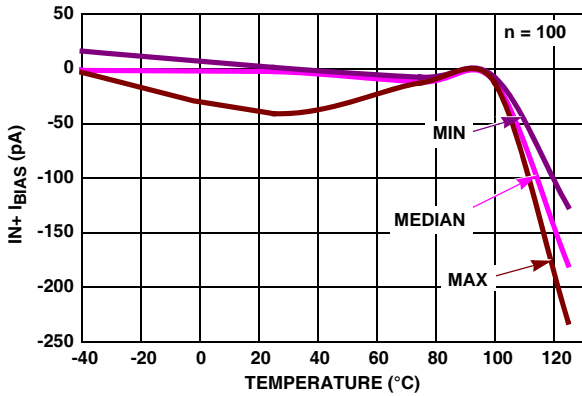

FIGURE 37. I_{BIAS} (IN+) vs TEMPERATURE, $V_+, V_- = \pm 2.5V$

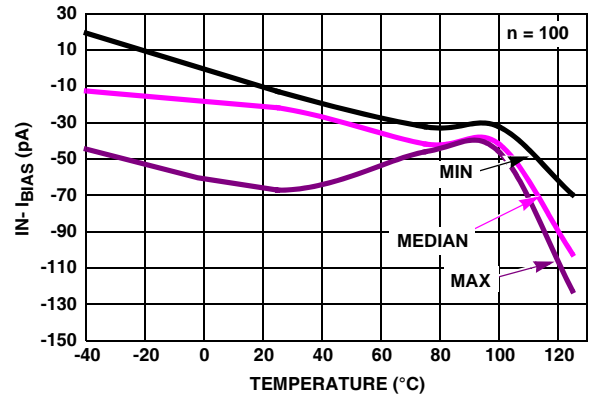

FIGURE 38. I_{BIAS} (IN-) vs TEMPERATURE, $V_+, V_- = \pm 2.5V$

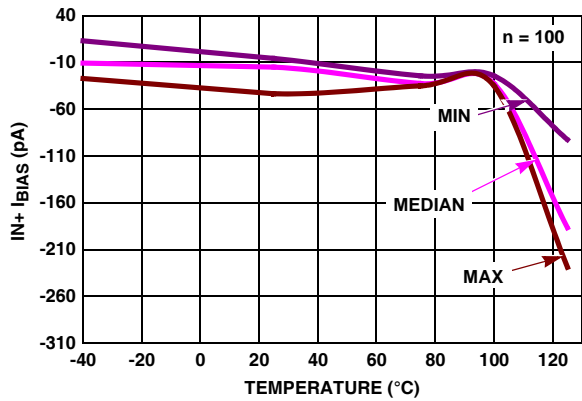

FIGURE 39. I_{BIAS} (IN+) vs TEMPERATURE, $V_+, V_- = \pm 1.2V$

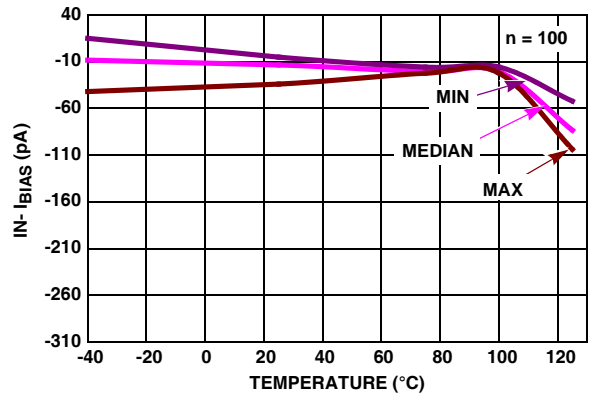

FIGURE 40. I_{BIAS} (IN-) vs TEMPERATURE, $V_+, V_- = \pm 1.2V$

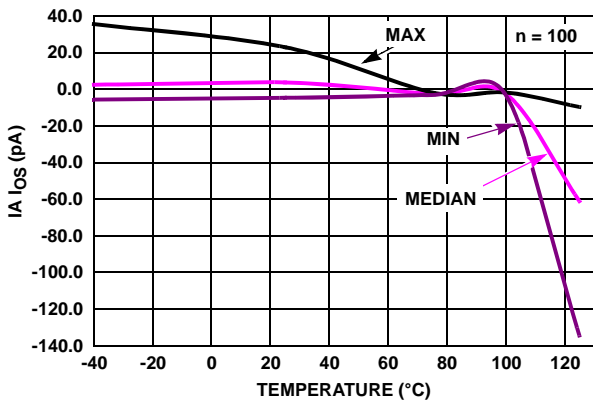

FIGURE 41. I_A INPUT OFFSET CURRENT vs TEMPERATURE, $V_+, V_- = \pm 2.5V$

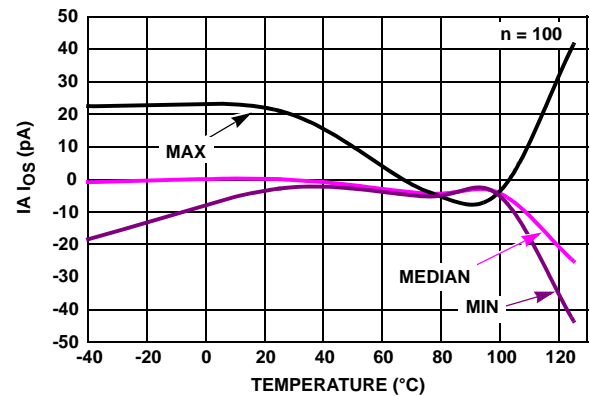

FIGURE 42. I_A INPUT OFFSET CURRENT vs TEMPERATURE, $V_+, V_- = \pm 1.2V$

ISL28274, ISL28474

Typical Performance Curves $V_+ = +5V, V_- = GND, V_{CM} = 1/2V_+, T_A = +25^\circ C$, unless otherwise specified. (Continued)

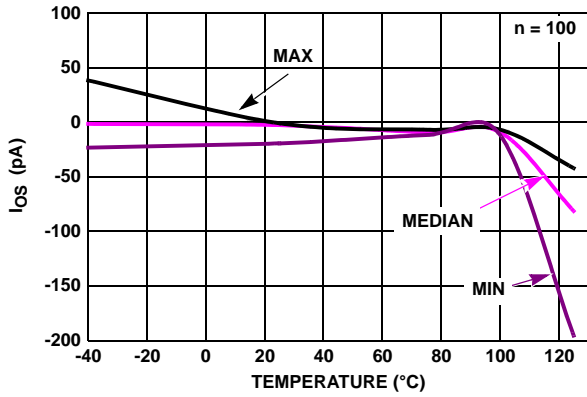

FIGURE 43. INPUT OFFSET CURRENT vs TEMPERATURE, $V_+, V_- = \pm 2.5V$

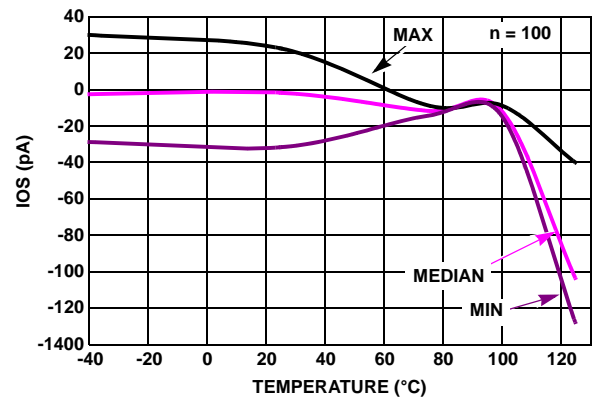

FIGURE 44. INPUT OFFSET CURRENT vs TEMPERATURE, $V_+, V_- = \pm 1.2V$

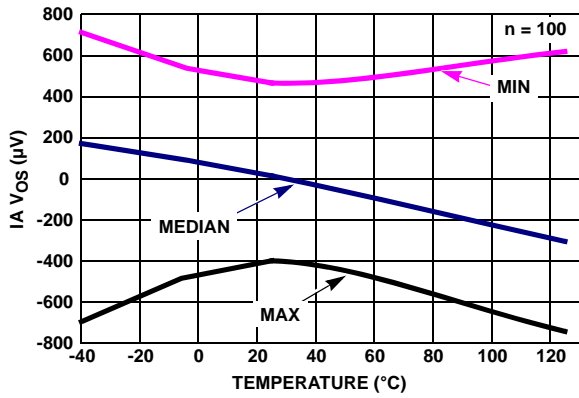

FIGURE 45. IA INPUT OFFSET VOLTAGE vs TEMPERATURE, $V_+, V_- = \pm 2.5V$

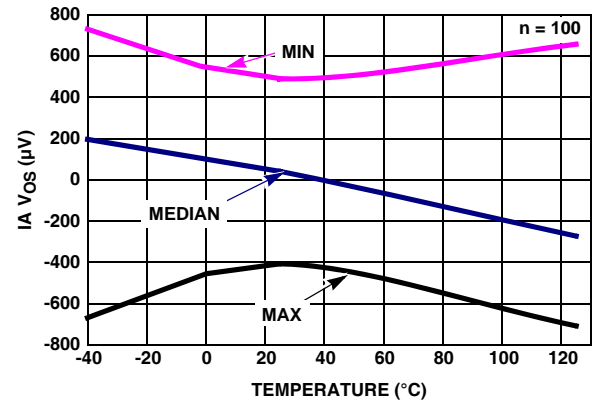

FIGURE 46. IA INPUT OFFSET VOLTAGE vs TEMPERATURE $V_+, V_- = \pm 1.2V$

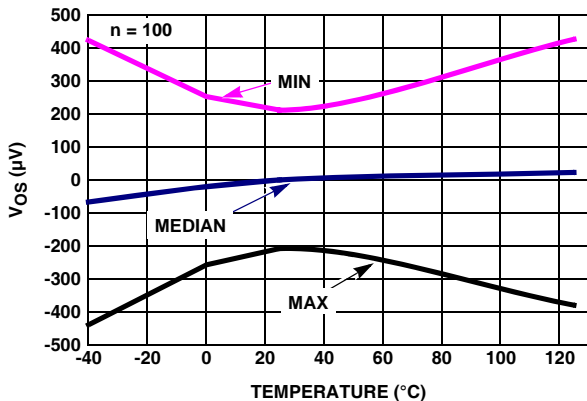

FIGURE 47. INPUT OFFSET VOLTAGE vs TEMPERATURE, $V_+, V_- = \pm 2.5V$

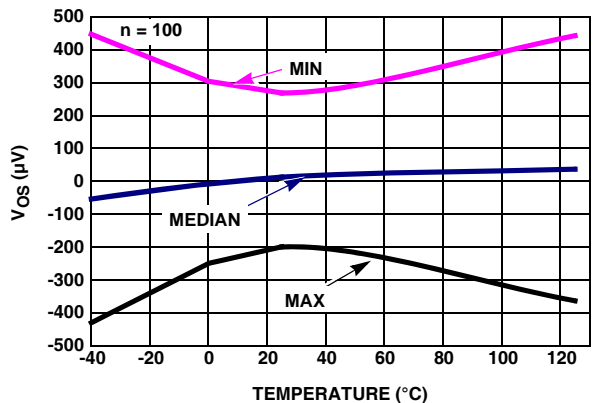

FIGURE 48. INPUT OFFSET VOLTAGE vs TEMPERATURE, $V_+, V_- = \pm 1.2V$

ISL28274, ISL28474

Typical Performance Curves $V_+ = +5V, V_- = GND, V_{CM} = 1/2V_+, T_A = +25^\circ C$, unless otherwise specified. (Continued)

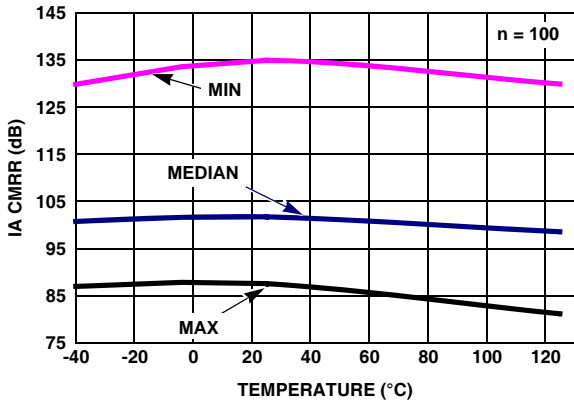

FIGURE 49. IA CMRR vs TEMPERATURE, $V_{CM} = +2.5V$ TO $-2.5V$

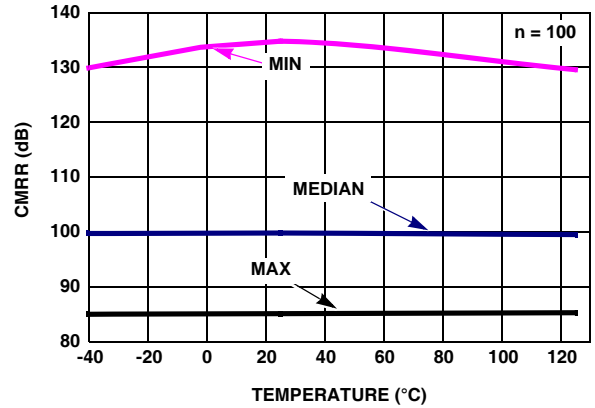

FIGURE 50. CMRR vs TEMPERATURE, $V_{CM} = +2.5V$ TO $-2.5V$

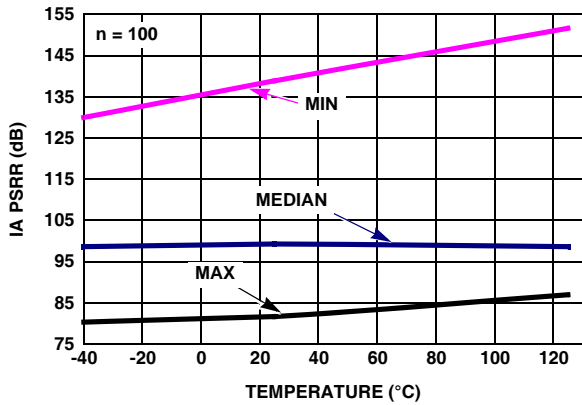

FIGURE 51. IA PSRR vs TEMPERATURE, $V_+, V_- = \pm 2.5V$

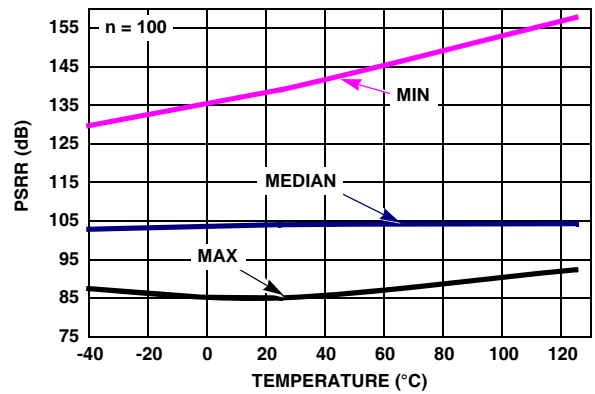

FIGURE 52. PSRR vs TEMPERATURE, $V_+, V_- = \pm 2.5V$

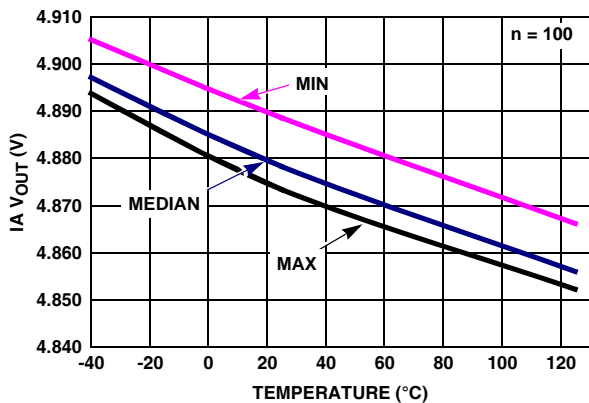

FIGURE 53. IA V_{OUT} HIGH vs TEMPERATURE, $R_L = 1k, V_+, V_- = \pm 2.5V$

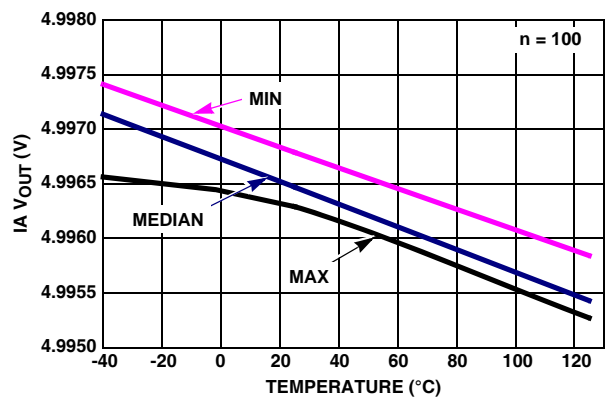

FIGURE 54. IA V_{OUT} HIGH vs TEMPERATURE, $R_L = 100k, V_+, V_- = \pm 2.5V$

ISL28274, ISL28474

Typical Performance Curves $V_+ = +5V, V_- = GND, V_{CM} = 1/2V_+, T_A = +25^\circ C$, unless otherwise specified. (Continued)

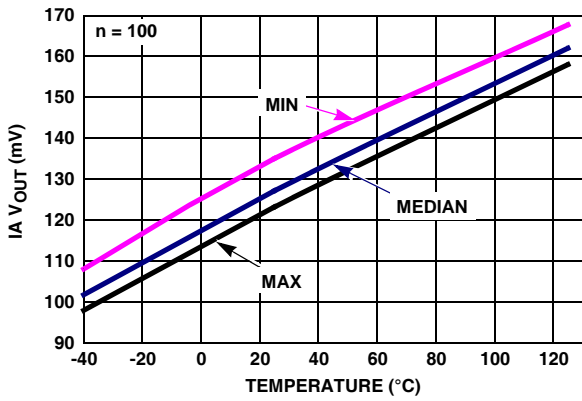

FIGURE 55. IA $V_{OUT LOW}$ vs TEMPERATURE, $R_L = 1k, V_+, V_- = \pm 2.5V$

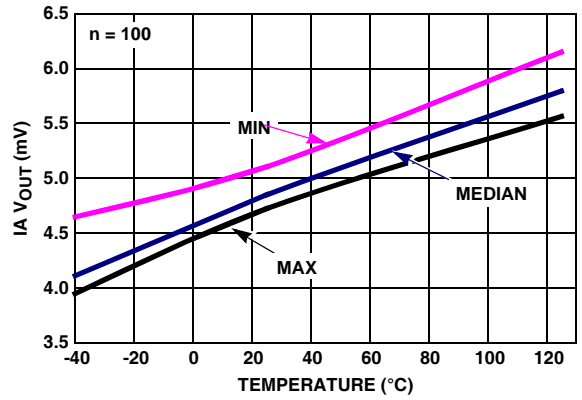

FIGURE 56. IA $V_{OUT LOW}$ vs TEMPERATURE, $R_L = 100k, V_+, V_- = \pm 2.5V$

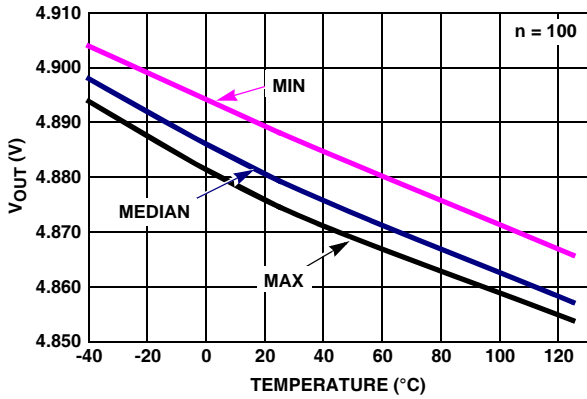

FIGURE 57. $V_{OUT HIGH}$ vs TEMPERATURE, $R_L = 1k, V_+, V_- = \pm 2.5V$

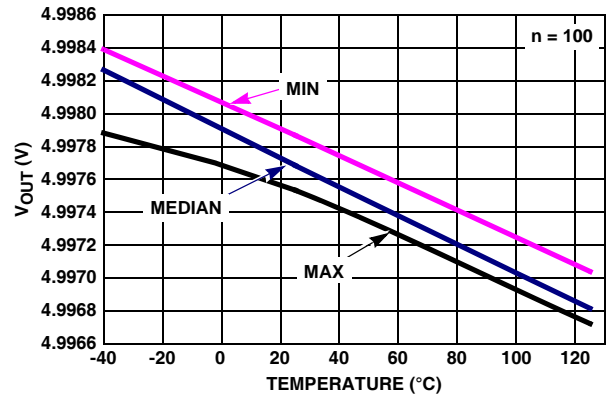

FIGURE 58. $V_{OUT HIGH}$ vs TEMPERATURE, $R_L = 100k, V_+, V_- = \pm 2.5V$

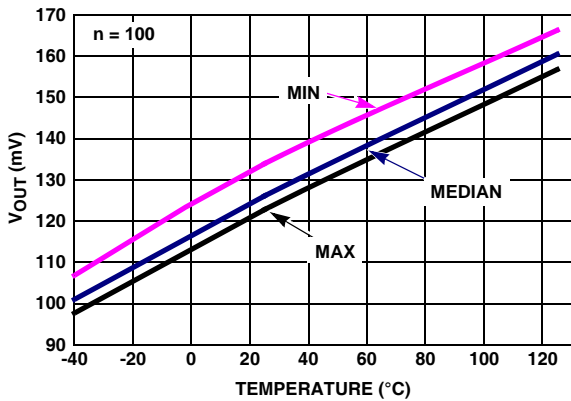

FIGURE 59. $V_{OUT LOW}$ vs TEMPERATURE, $R_L = 1k, V_+, V_- = \pm 2.5V$

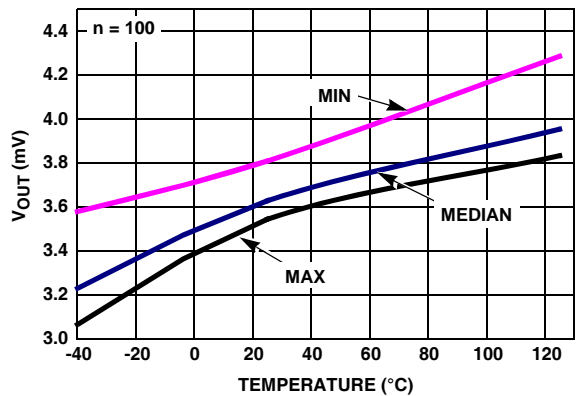

FIGURE 60. $V_{OUT LOW}$ vs TEMPERATURE, $R_L = 100k, V_+, V_- = \pm 2.5V$

ISL28274, ISL28474

Pin Descriptions

ISL28274 (16 LD QSOP)	ISL28474 (24 LD QSOP)	PIN NAME	EQUIVALENT CIRCUIT	DESCRIPTION
1, 9, 13, 14	11, 14	NC		No internal connection
2	1, 24	IA OUT IA OUT_1 IA OUT_2	Circuit 2	Instrumentation Amplifier output
3	2, 23	IA FB+ IA FB+_1 IA FB+_2	Circuit 1	Instrumentation Amplifier Feedback from non-inverting output
4	3, 22	IA FB- IA FB-_1 IA FB-_2	Circuit 1	Instrumentation Amplifier Feedback from inverting output
5	4, 21	IA IN- IA IN-_1 IA IN-_2	Circuit 1	Instrumentation Amplifier inverting input
6	5, 20	IA IN+ IA IN+_1 IA IN+_2	Circuit 1	Instrumentation Amplifier non-inverting input
7	6, 19	DNC		Do Not Connect, Internal connection - Must be left floating
8	18	V-	Circuit 3	Negative power supply
10	8, 17	DNC		Do Not Connect, Internal connection - Must be left floating
11	9, 16	IN+ IN+ 1 IN+ 2	Circuit 1	Amplifier non-inverting input
12	10, 15	IN- IN- 1 IN- 2	Circuit 1	Amplifier inverting input
15	12, 13	OUT OUT 1 OUT 2	Circuit 2	Amplifier output
16	7	V+	Circuit 3	Positive power supply

IA = Instrumentation Amplifier

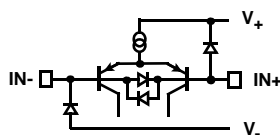

CIRCUIT 1

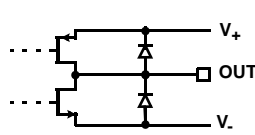

CIRCUIT 2

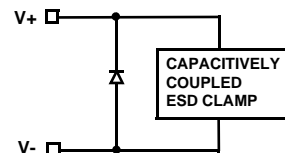

CIRCUIT 3

Description of Operation and Application Information

Product Description

The ISL28274 and ISL28474 provide both a micropower instrumentation amplifier (Amp A) and a low power precision amplifier (Amp B) in the same package. The amplifiers deliver rail-to-rail input amplification and rail-to-rail output swing on a single 2.4V to 5V supply. They also deliver excellent DC and AC specifications while consuming only 60µA typical supply current per amplifier. Because the instrumentation amplifiers provide an independent pair of feedback terminals to set the gain and to adjust the output

level, the in-amp achieves high common-mode rejection ratio regardless of the tolerance of the gain setting resistors. The instrumentation amplifier is internally compensated for a minimum closed loop gain of 100 or greater.

Input Protection

The input and feedback terminals have internal ESD protection diodes to both positive and negative supply rails, limiting the input voltage to within one diode drop beyond the supply rails. If overdriving the inputs is necessary, the external input current must never exceed 5mA. An external series resistor may be used as a protection to limit excessive external voltage and current from damaging the inputs.

ISL28274, ISL28474

Input Stage and Input Voltage Range

The input terminals (IN+ and IN-) of both amplifiers "A" and "B" are single differential pair P-MOSFET devices aided by an Input Range Enhancement Circuit to increase the headroom of operation of the common-mode input voltage. The feedback terminals (FB+ and FB-) of amplifier "A" also have a similar topology. As a result, the input common-mode voltage range is rail-to-rail. These amps are able to handle input voltages that are at or slightly beyond the supply and ground making them well suited for single 5V or 3.3V low voltage supply systems. There is no need then to move the common-mode input to achieve symmetrical input voltage.

Output Stage and Output Voltage Range

A pair of complementary MOSFET devices drives the output V_{OUT} to within a few mV of the supply rails. At a 100kΩ load, the PMOS sources current and pulls the output up to 4mV below the positive supply, while the NMOS sinks current and pulls the output down to 3mV above the negative supply, or ground in the case of a single supply operation. The current sinking and sourcing capability of the ISL28274 are internally limited to 31mA.

Gain Setting of Instrumentation Amp "A"

V_{IN}, the potential difference across IN+ and IN-, is replicated (less the input offset voltage) across FB+ and FB-. The goal of the ISL28274 in-amp is to maintain the differential voltage across FB+ and FB- equal to IN+ and IN-; (FB+ - FB-) = (IN+ - IN-). Consequently, the transfer function can be derived. The gain is set by two external resistors, the feedback resistor R_F and the gain resistor R_G.

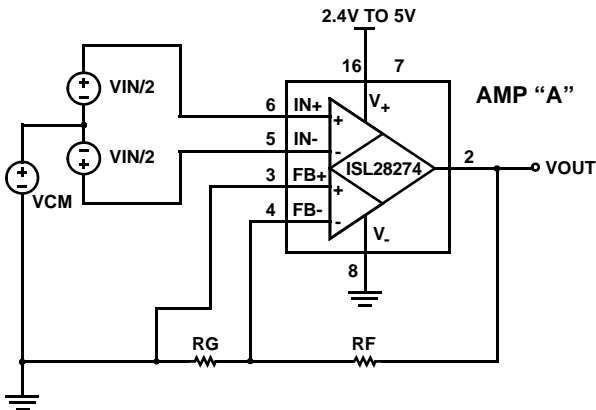

FIGURE 61. GAIN IS BY EXTERNAL RESISTORS R_F AND R_G

$$V_{OUT} = \left(1 + \frac{R_F}{R_G}\right) V_{IN} \quad (\text{EQ. 1})$$

In Figure 61, the FB+ pin and one end of resistor R_G are connected to GND. With this configuration, Equation 1 is only true for a positive swing in V_{IN}; negative input swings will be ignored and the output will be at ground.

Reference Connection

Unlike a three-op amp instrumentation amplifier, a finite series resistance seen at the REF terminal does not degrade the high CMRR performance, eliminating the need for an additional external buffer amplifier. Figure 62 uses the FB+ pin to provide a high impedance REF terminal.

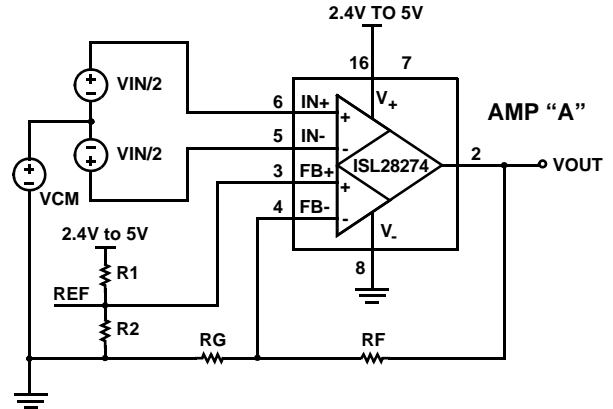

FIGURE 62. GAIN SETTING AND REFERENCE CONNECTION

$$V_{OUT} = \left(1 + \frac{R_F}{R_G}\right) (V_{IN}) + \left(1 + \frac{R_F}{R_G}\right) (V_{REF}) \quad (\text{EQ. 2})$$

The FB+ pin is used as a REF terminal to center or to adjust the output. Because the FB+ pin is a high impedance input, an economical resistor divider can be used to set the voltage at the REF terminal without degrading or affecting the CMRR performance. Any voltage applied to the REF terminal will shift V_{OUT} by V_{REF} times the closed loop gain, which is set by resistors R_F and R_G as shown in Figure 62.

The FB+ pin can also be connected to the other end of resistor, R_G. See Figure 63. Keeping the basic concept that the in-amps maintain constant differential voltage across the input terminals and feedback terminals (IN+ - IN- = FB+ - FB-), the transfer function of Figure 63 can be derived.

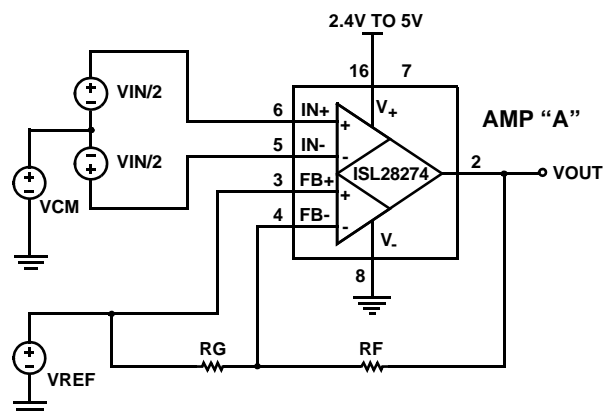

FIGURE 63. REFERENCE CONNECTION WITH AN AVAILABLE V_{REF}

ISL28274, ISL28474

$$V_{OUT} = \left(1 + \frac{R_F}{R_G}\right)(V_{IN}) + (V_{REF}) \quad (\text{EQ. 3})$$

A finite resistance R_S in series with the V_{REF} source, adds an output offset of $V_{IN} \cdot (R_S/R_G)$. As the series resistance R_S approaches zero, the gain equation is simplified to Equation 3 for Figure 63. V_{OUT} is simply shifted by an amount V_{REF} .

External Resistor Mismatches

Because of the independent pair of feedback terminals provided by the ISL28274, the CMRR is not degraded by any resistor mismatches. Hence, unlike a three op amp and especially a two op amp in-amp, the ISL28274 reduces the cost of external components by allowing the use of 1% or more tolerance resistors without sacrificing CMRR performance. The ISL28274 CMRR will be 100dB regardless of the tolerance of the resistors used.

Using Only the Instrumentation Amplifier

If the application only requires the instrumentation amp, the user must configure the unused op amp to prevent it from oscillating. The unused op amp will oscillate if the input and output pins are floating. This will result in higher than expected supply currents and possible noise injection into the in-amp. The proper way to prevent this oscillation is to short the output to the negative input and ground the positive input (as shown in Figure 64).

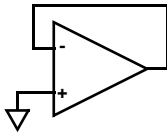

FIGURE 64. PREVENTING OSCILLATIONS IN UNUSED CHANNELS

Proper Layout Maximizes Performance

To achieve the maximum performance of the high input impedance and low offset voltage, care should be taken in the circuit board layout. The PC board surface must remain clean and free of moisture to avoid leakage currents between adjacent traces. Surface coating of the circuit board will reduce surface moisture and provide a humidity barrier, reducing parasitic resistance on the board. When input leakage current is a concern, the use of guard rings around the amplifier inputs will further reduce leakage currents. Figure 65 shows a guard ring example for a unity gain amplifier that uses the low impedance amplifier output at the same voltage as the high impedance input to eliminate surface leakage. The guard ring does not need to be a specific width, but it should form a continuous loop around both inputs. For further reduction of leakage currents, components can be mounted to the PC board using Teflon standoff insulators.

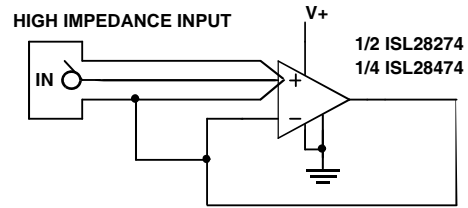

FIGURE 65. GUARD RING EXAMPLE FOR UNITY GAIN AMPLIFIER

Current Limiting

The ISL28274 has no internal current-limiting circuitry. If the output is shorted, it is possible to exceed the Absolute Maximum Rating for output current or power dissipation, potentially resulting in the destruction of the device.

Power Dissipation

It is possible to exceed the +150°C maximum junction temperatures under certain load and power-supply conditions. It is therefore important to calculate the maximum junction temperature (T_{JMAX}) for all applications to determine if power supply voltages, load conditions, or package type need to be modified to remain in the safe operating area. These parameters are related in Equation 4:

$$T_{JMAX} = T_{MAX} + (\theta_{JA} \times PD_{MAXTOTAL}) \quad (\text{EQ. 4})$$

where:

- $PD_{MAXTOTAL}$ is the sum of the maximum power dissipation of each amplifier in the package (PD_{MAX})
- PD_{MAX} for each amplifier can be calculated as shown in Equation 5:

$$PD_{MAX} = 2 \cdot V_S \times I_{SMAX} + (V_S - V_{OUTMAX}) \times \frac{V_{OUTMAX}}{R_L} \quad (\text{EQ. 5})$$

where:

- T_{MAX} = Maximum ambient temperature
- θ_{JA} = Thermal resistance of the package
- PD_{MAX} = Maximum power dissipation of 1 amplifier
- V_S = Supply voltage (Magnitude of V_+ and V_-)
- I_{SMAX} = Maximum supply current of 1 amplifier
- V_{OUTMAX} = Maximum output voltage swing of the application
- R_L = Load resistance

ISL28274, ISL28474

Quarter Size Outline Plastic Packages Family (QSOP)

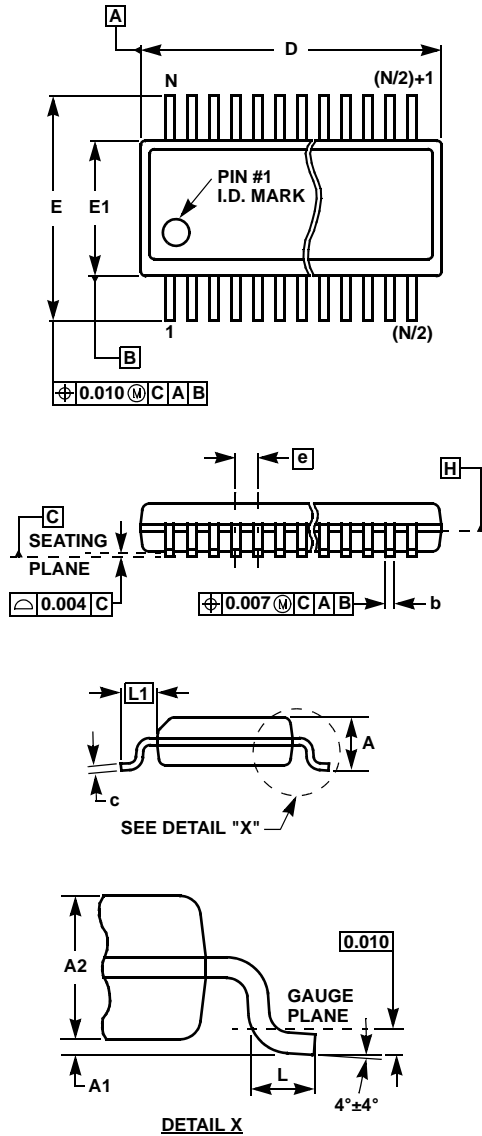

MDP0040

QUARTER SIZE OUTLINE PLASTIC PACKAGES FAMILY

SYMBOL	INCHES			TOLERANCE	NOTES
	QSOP16	QSOP24	QSOP28		
A	0.068	0.068	0.068	Max.	-
A1	0.006	0.006	0.006	± 0.002	-
A2	0.056	0.056	0.056	± 0.004	-
b	0.010	0.010	0.010	± 0.002	-
c	0.008	0.008	0.008	± 0.001	-
D	0.193	0.341	0.390	± 0.004	1, 3
E	0.236	0.236	0.236	± 0.008	-
E1	0.154	0.154	0.154	± 0.004	2, 3
e	0.025	0.025	0.025	Basic	-
L	0.025	0.025	0.025	± 0.009	-
L1	0.041	0.041	0.041	Basic	-
N	16	24	28	Reference	-

Rev. F 2/07

NOTES:

1. Plastic or metal protrusions of 0.006" maximum per side are not included.
2. Plastic interlead protrusions of 0.010" maximum per side are not included.
3. Dimensions "D" and "E1" are measured at Datum Plane "H".
4. Dimensioning and tolerancing per ASME Y14.5M-1994.

All Intersil U.S. products are manufactured, assembled and tested utilizing ISO9000 quality systems. Intersil Corporation's quality certifications can be viewed at www.intersil.com/design/quality

Intersil products are sold by description only. Intersil Corporation reserves the right to make changes in circuit design, software and/or specifications at any time without notice. Accordingly, the reader is cautioned to verify that data sheets are current before placing orders. Information furnished by Intersil is believed to be accurate and reliable. However, no responsibility is assumed by Intersil or its subsidiaries for its use; nor for any infringements of patents or other rights of third parties which may result from its use. No license is granted by implication or otherwise under any patent or patent rights of Intersil or its subsidiaries.

For information regarding Intersil Corporation and its products, see www.intersil.com