

Excellent Integrated System Limited

Stocking Distributor

Click to view price, real time Inventory, Delivery & Lifecycle Information:

[IXYS Corporation](#)
[VUO110-08NO7](#)

For any questions, you can email us directly:

sales@integrated-circuit.com

Standard Rectifier Module

3~ Rectifier	
V_{RRM}	= 800 V
I_{DAV}	= 125 A
I_{FSM}	= 1200 A

3~ Rectifier Bridge

Part number

VUO110-08NO7

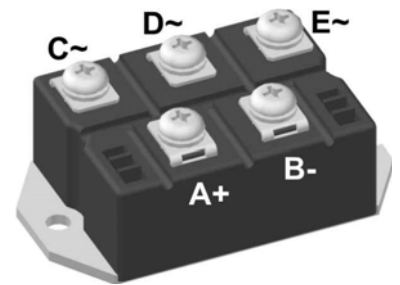

 E72873

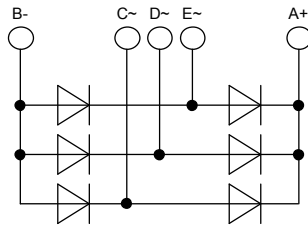

Features / Advantages:

- Package with DCB ceramic
- Improved temperature and power cycling
- Planar passivated chips
- Very low forward voltage drop
- Very low leakage current

Applications:

- Diode for main rectification
- For three phase bridge configurations
- Supplies for DC power equipment
- Input rectifiers for PWM inverter
- Battery DC power supplies
- Field supply for DC motors

Package: PWS-E

- Industry standard outline
- RoHS compliant
- Easy to mount with two screws
- Base plate: Copper internally DCB isolated
- Advanced power cycling

Rectifier				Ratings			
Symbol	Definition	Conditions	min.	typ.	max.	Unit	
V_{RSM}	max. non-repetitive reverse blocking voltage				900	V	
V_{RRM}	max. repetitive reverse blocking voltage				800	V	
I_R	reverse current	$V_R = 800\text{ V}$	$T_{VJ} = 25^\circ\text{C}$		100	μA	
		$V_R = 800\text{ V}$	$T_{VJ} = 150^\circ\text{C}$		2	mA	
V_F	forward voltage drop	$I_F = 50\text{ A}$	$T_{VJ} = 25^\circ\text{C}$		1.13	V	
					1.46	V	
		$I_F = 150\text{ A}$	$T_{VJ} = 125^\circ\text{C}$		1.04	V	
					1.47	V	
I_{DAV}	bridge output current	$T_C = 110^\circ\text{C}$ rectangular $d = \frac{1}{3}$	$T_{VJ} = 150^\circ\text{C}$		125	A	
V_{F0}	threshold voltage	} for power loss calculation only	$T_{VJ} = 150^\circ\text{C}$		0.79	V	
r_F	slope resistance				4.5	m Ω	
R_{thJC}	thermal resistance junction to case				0.7	K/W	
R_{thCH}	thermal resistance case to heatsink			0.3		K/W	
P_{tot}	total power dissipation		$T_C = 25^\circ\text{C}$		175	W	
I_{FSM}	max. forward surge current	$t = 10\text{ ms}; (50\text{ Hz}), \text{ sine}$	$T_{VJ} = 45^\circ\text{C}$		1.20	kA	
					1.30	kA	
		$t = 8,3\text{ ms}; (60\text{ Hz}), \text{ sine}$	$V_R = 0\text{ V}$	$T_{VJ} = 150^\circ\text{C}$		1.02	kA
						1.10	kA
I^2t	value for fusing	$t = 10\text{ ms}; (50\text{ Hz}), \text{ sine}$	$T_{VJ} = 45^\circ\text{C}$		7.20	kA ² s	
					6.98	kA ² s	
		$t = 8,3\text{ ms}; (60\text{ Hz}), \text{ sine}$	$V_R = 0\text{ V}$	$T_{VJ} = 150^\circ\text{C}$		5.20	kA ² s
						5.04	kA ² s
C_J	junction capacitance	$V_R = 400\text{ V}; f = 1\text{ MHz}$	$T_{VJ} = 25^\circ\text{C}$	37		pF	



VUO110-08NO7

Package PWS-E		Ratings				
Symbol	Definition	Conditions	min.	typ.	max.	Unit
I_{RMS}	RMS current	per terminal			200	A
T_{stg}	storage temperature		-40		125	°C
T_{vj}	virtual junction temperature		-40		150	°C
Weight				284		g
M_D	mounting torque		4.25		5.75	Nm
M_T	terminal torque		4.25		5.75	Nm
$d_{Spp/App}$	creepage distance on surface striking distance through air	terminal to terminal	12.0			mm
$d_{Spb/Apb}$		terminal to backside	26.0			mm
V_{ISOL}	isolation voltage	t = 1 second	3000			V
		t = 1 minute	2500			V

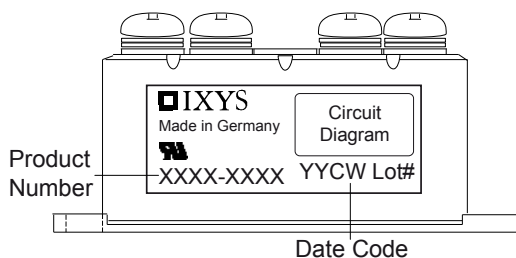

Ordering	Part Number	Marking on Product	Delivery Mode	Quantity	Code No.
Standard	VUO110-08NO7	VUO110-08NO7	Box	5	462365

Equivalent Circuits for Simulation

* on die level

$T_{vj} = 150\text{ °C}$

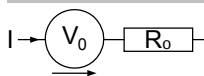

Rectifier

$V_{0\ max}$	threshold voltage	0.79	V
$R_{0\ max}$	slope resistance *	3.3	mΩ

Outlines PWS-E

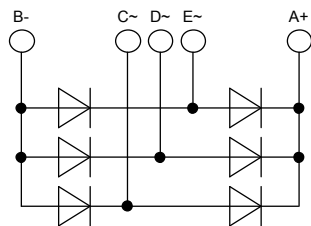
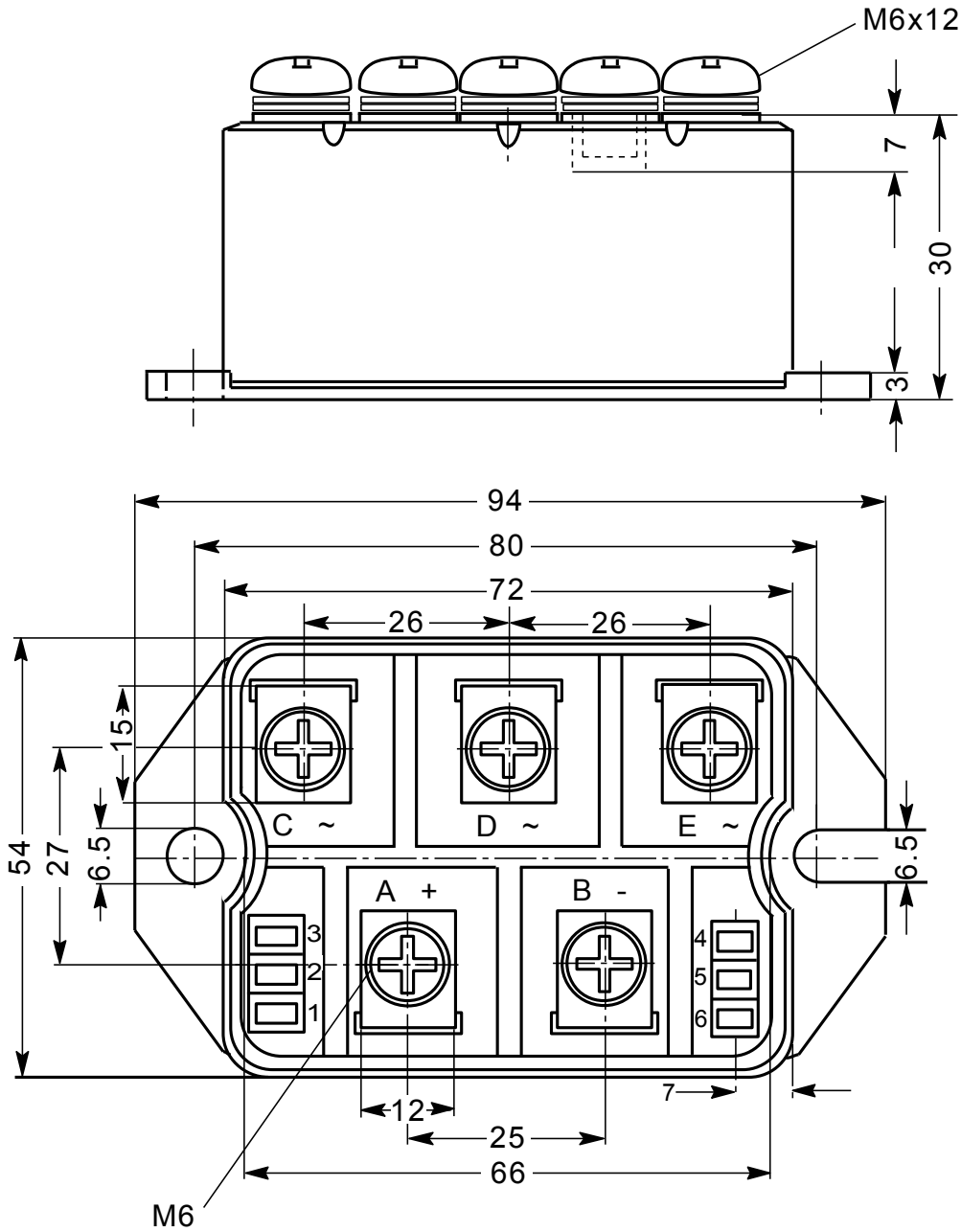

Rectifier

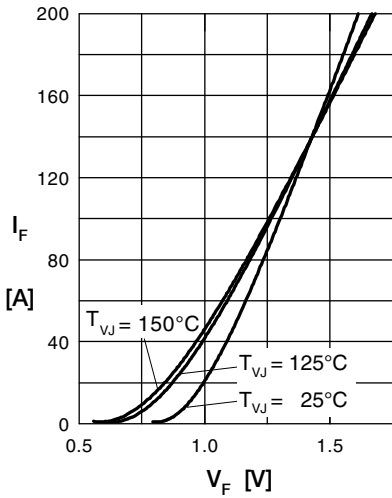

Fig. 1 Forward current vs. voltage drop per diode

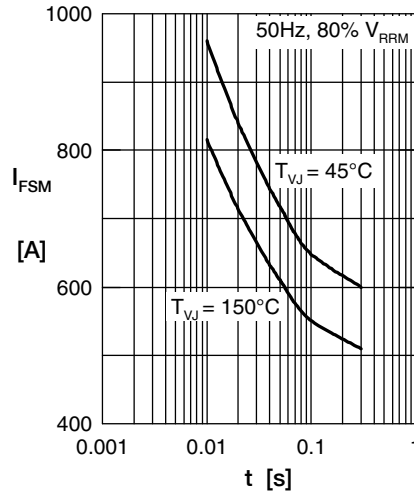

Fig. 2 Surge overload current vs. time per diode

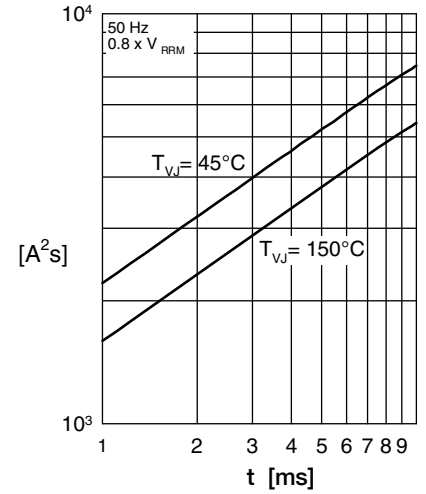

Fig. 3 I^2t vs. time per diode

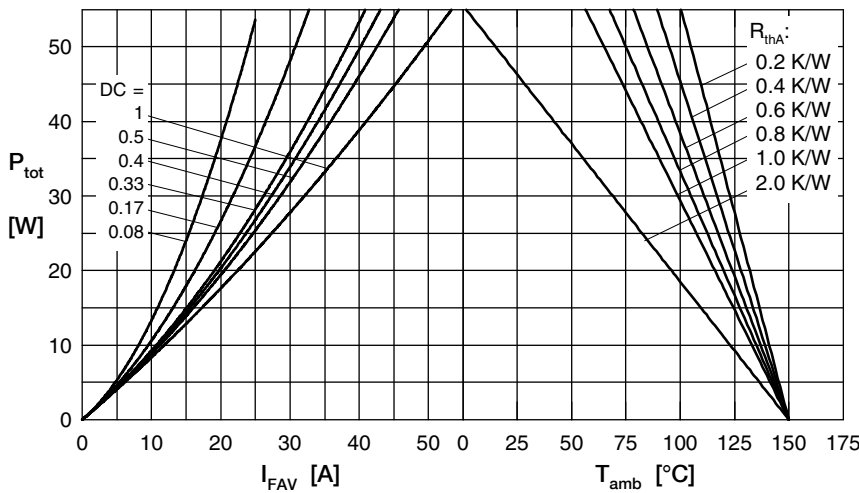

Fig. 4 Power dissipation vs. forward current and ambient temperature per diode

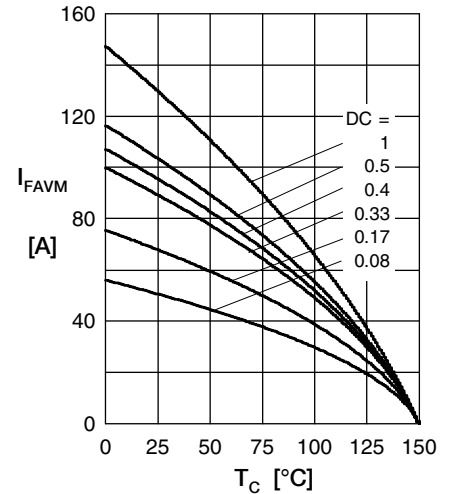

Fig. 5 Max. forward current vs. case temperature per diode

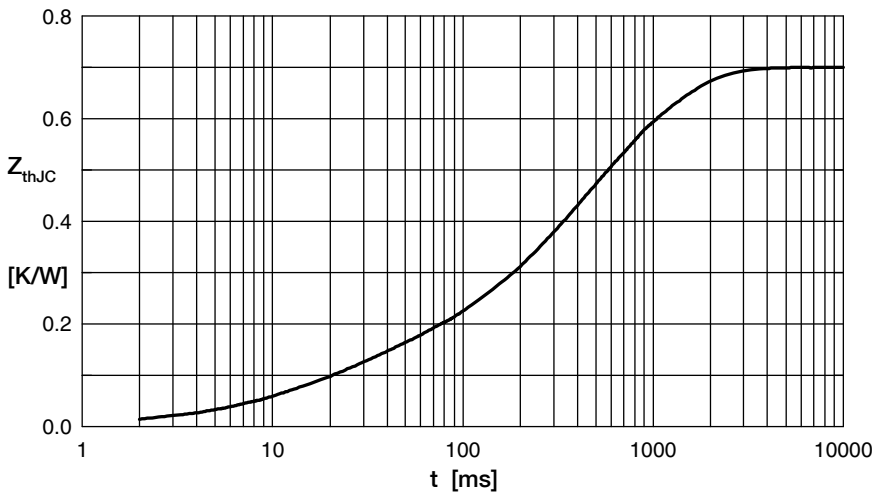

Fig. 6 Transient thermal impedance junction to case vs. time per diode