

Excellent Integrated System Limited

Stocking Distributor

Click to view price, real time Inventory, Delivery & Lifecycle Information:

[IXYS Corporation](#)
[VUO86-12NO7](#)

For any questions, you can email us directly:
sales@integrated-circuit.com

Standard Rectifier Module

3~ Rectifier	
V_{RRM}	= 1200 V
I_{DAV}	= 90 A
I_{FSM}	= 550 A

3~ Rectifier Bridge

Part number

VUO86-12N07

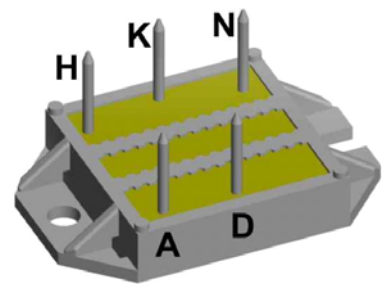

 E72873

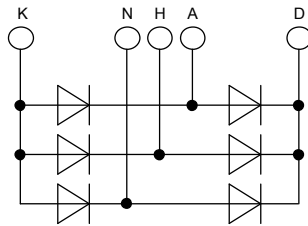

Features / Advantages:

- Package with DCB ceramic
- Improved temperature and power cycling
- Planar passivated chips
- Very low forward voltage drop
- Very low leakage current

Applications:

- Diode for main rectification
- For three phase bridge configurations
- Supplies for DC power equipment
- Input rectifiers for PWM inverter
- Battery DC power supplies
- Field supply for DC motors

Package: ECO-PAC1

- Industry standard outline
- RoHS compliant
- Soldering pins for PCB mounting
- Height: 9 mm
- Base plate: DCB ceramic
- Reduced weight
- Advanced power cycling

Rectifier				Ratings			
Symbol	Definition	Conditions	min.	typ.	max.	Unit	
V_{RSM}	max. non-repetitive reverse blocking voltage				1300	V	
V_{RRM}	max. repetitive reverse blocking voltage				1200	V	
I_R	reverse current	$V_R = 1200\text{ V}$			40	μA	
		$V_R = 1200\text{ V}$			1.5	mA	
V_F	forward voltage drop	$I_F = 30\text{ A}$			1.14	V	
		$I_F = 90\text{ A}$			1.48	V	
		$I_F = 30\text{ A}$	$T_{VJ} = 125^\circ\text{C}$			1.06	V
		$I_F = 90\text{ A}$				1.51	V
I_{DAV}	bridge output current	$T_C = 105^\circ\text{C}$ rectangular $d = \frac{1}{3}$			90	A	
V_{F0}	threshold voltage	} for power loss calculation only			0.81	V	
r_F	slope resistance				7.8	m Ω	
R_{thJC}	thermal resistance junction to case				0.9	K/W	
R_{thCH}	thermal resistance case to heatsink			0.4		K/W	
P_{tot}	total power dissipation				135	W	
I_{FSM}	max. forward surge current	$t = 10\text{ ms}; (50\text{ Hz}), \text{ sine}$	$T_{VJ} = 45^\circ\text{C}$			550	A
		$t = 8,3\text{ ms}; (60\text{ Hz}), \text{ sine}$	$V_R = 0\text{ V}$			595	A
		$t = 10\text{ ms}; (50\text{ Hz}), \text{ sine}$	$T_{VJ} = 150^\circ\text{C}$			470	A
		$t = 8,3\text{ ms}; (60\text{ Hz}), \text{ sine}$	$V_R = 0\text{ V}$			505	A
I^2t	value for fusing	$t = 10\text{ ms}; (50\text{ Hz}), \text{ sine}$	$T_{VJ} = 45^\circ\text{C}$			1.52	kA ² s
		$t = 8,3\text{ ms}; (60\text{ Hz}), \text{ sine}$	$V_R = 0\text{ V}$			1.48	kA ² s
		$t = 10\text{ ms}; (50\text{ Hz}), \text{ sine}$	$T_{VJ} = 150^\circ\text{C}$			1.11	kA ² s
		$t = 8,3\text{ ms}; (60\text{ Hz}), \text{ sine}$	$V_R = 0\text{ V}$			1.06	kA ² s
C_J	junction capacitance	$V_R = 400\text{ V}; f = 1\text{ MHz}$	$T_{VJ} = 25^\circ\text{C}$		18	pF	



VUO86-12NO7

Package ECO-PAC1				Ratings			
Symbol	Definition	Conditions		min.	typ.	max.	Unit
I_{RMS}	RMS current	per terminal				100	A
T_{stg}	storage temperature			-40		125	°C
T_{vj}	virtual junction temperature			-40		150	°C
Weight					19		g
M_D	mounting torque			1.5		2	Nm
$d_{Spp/App}$	creepage distance on surface striking distance through air	terminal to terminal		6.0			mm
$d_{Spb/Apb}$		terminal to backside		10.0			mm
V_{ISOL}	isolation voltage	t = 1 second	50/60 Hz, RMS; $I_{ISOL} \leq 1$ mA	3000			V
		t = 1 minute		2500			V

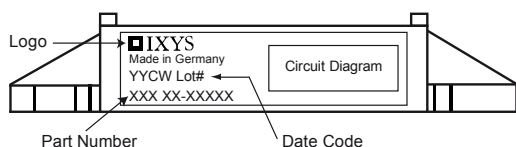

Ordering	Part Number	Marking on Product	Delivery Mode	Quantity	Code No.
Standard	VUO86-12NO7	VUO86-12NO7	Box	25	479594

Equivalent Circuits for Simulation

* on die level

$T_{vj} = 150^\circ\text{C}$

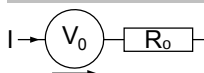

Rectifier

$V_{0\max}$	threshold voltage	0.81	V
$R_{0\max}$	slope resistance *	6.6	mΩ

Outlines ECO-PAC1

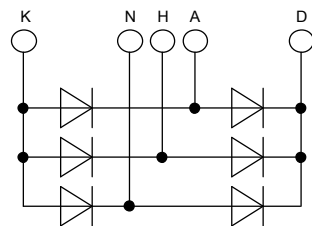
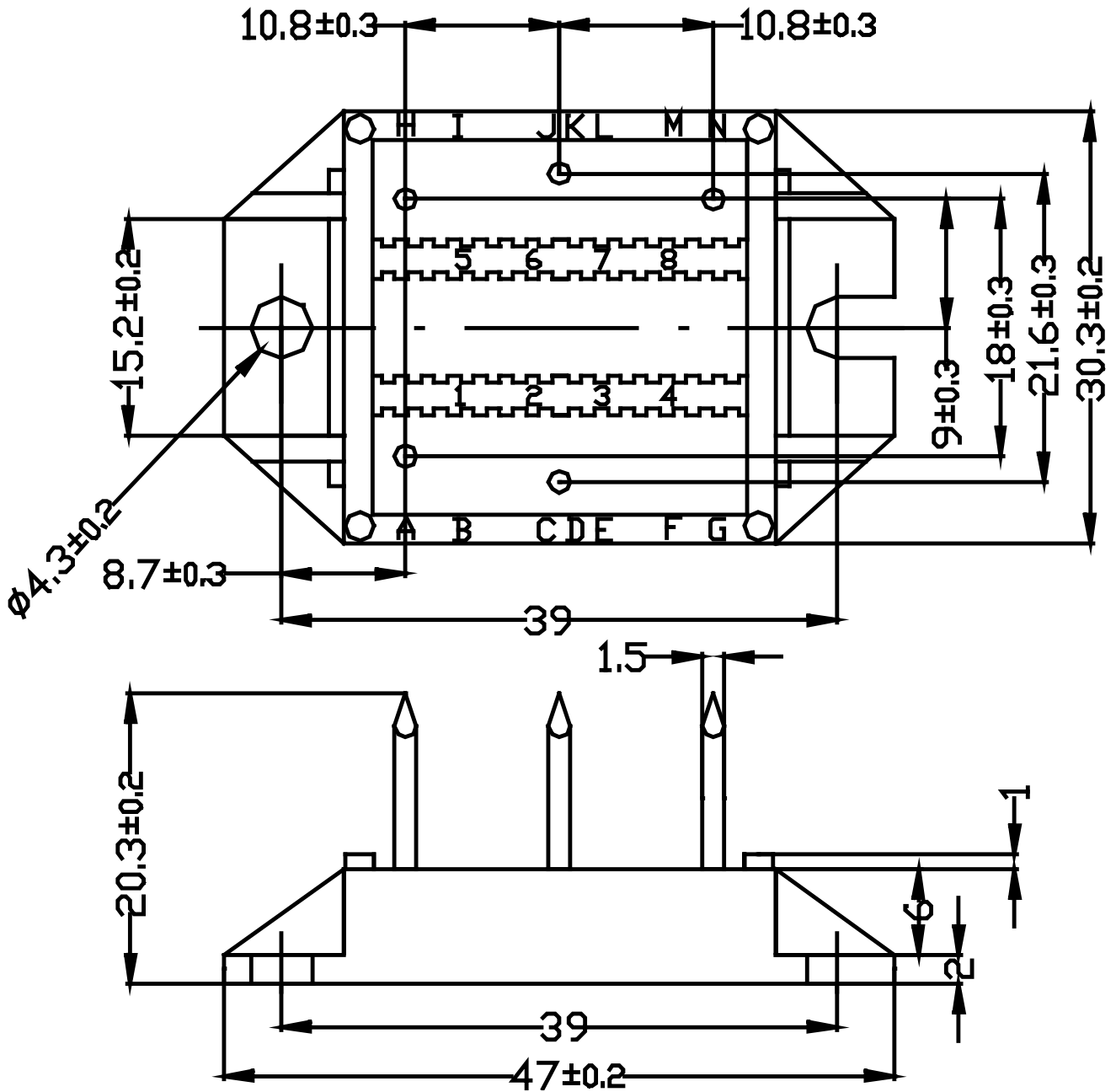

Rectifier

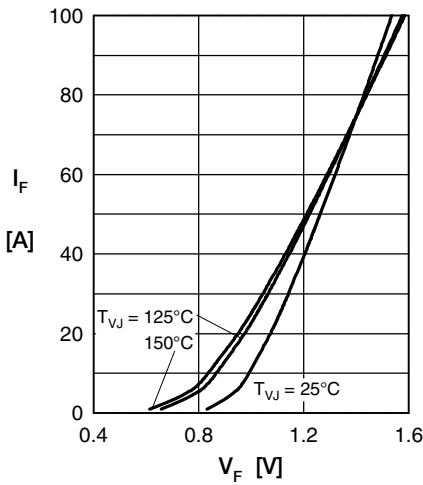

Fig. 1 Forward current versus voltage drop per diode

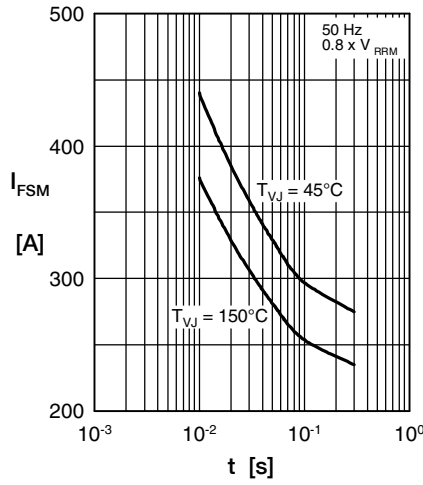

Fig. 2 Surge overload current

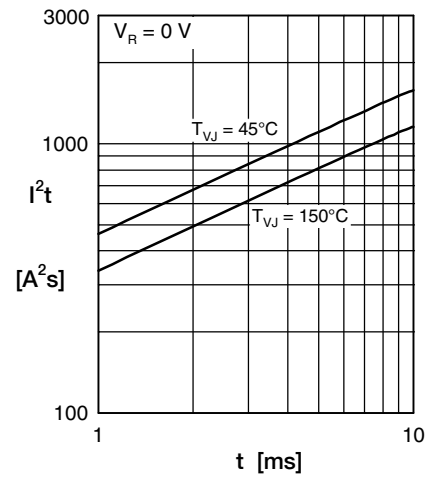

Fig. 3 I²t versus time per diode

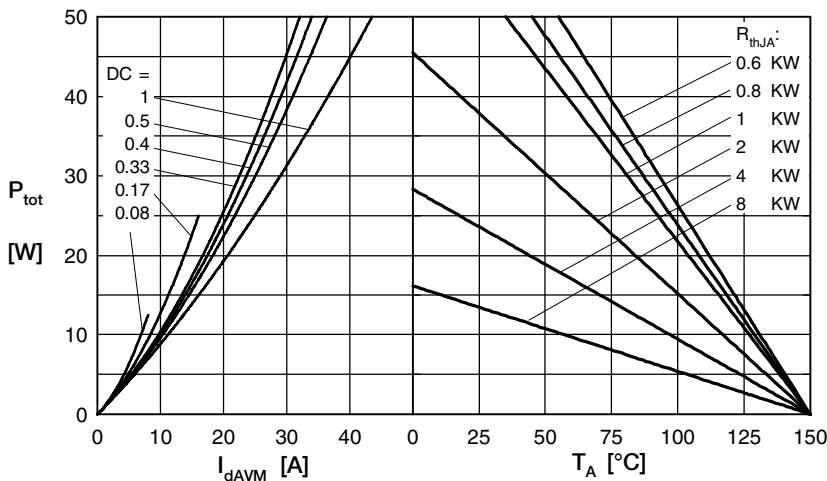

Fig. 4 Power dissipation vs. direct output current & ambient temperature

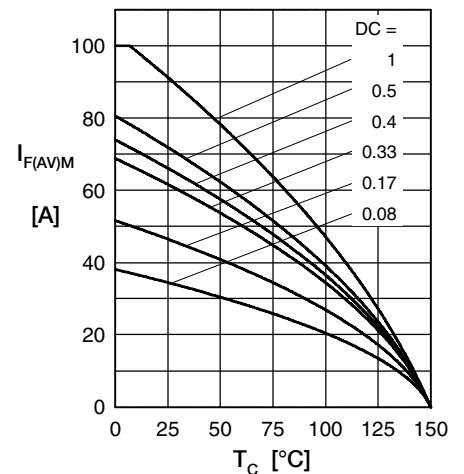

Fig. 5 Max. forward current vs. case temperature

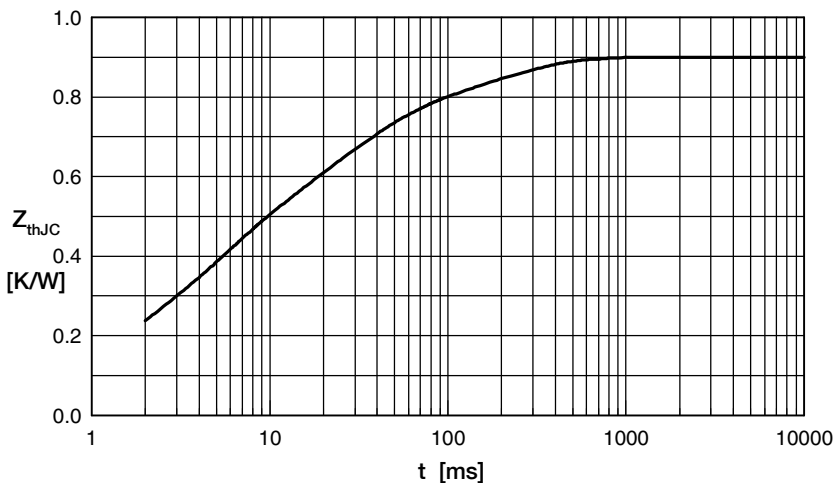

Fig. 6 Transient thermal impedance junction to case

Constants for Z_{thJC} calculation:

i	R_{th} (K/W)	t_i (s)
1	0.0607	0.000
2	0.1230	0.00256
3	0.2330	0.0045
4	0.3230	0.0242
5	0.1628	0.18