

Excellent Integrated System Limited

Stocking Distributor

Click to view price, real time Inventory, Delivery & Lifecycle Information:

[STMicroelectronics](#)
[STPS10L60CG-TR](#)

For any questions, you can email us directly:

sales@integrated-circuit.com



STPS10L60C

Power Schottky rectifier

Features

- Low forward voltage drop
- Negligible switching losses
- Insulated package:
 - Insulating voltage = 2000 V DC
 - Capacitance = 12 pF
- Avalanche capability specified

Description

Dual center tap Schottky rectifier suited for switch mode power supplies and high frequency DC to DC converters.

Packaged in TO-220FPAB, this device is intended for use in high frequency inverters.

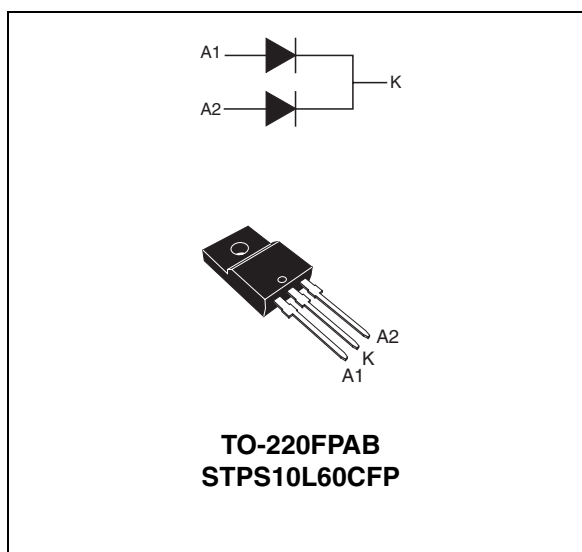

Table 1. Device summary

$I_{F(AV)}$	2 x 5 A
V_{RRM}	60 V
$T_j(max)$	150 °C
$V_F(max)$	0.52 V

Characteristics

STPS10L60C

1 Characteristics

Table 2. Absolute ratings (limiting values, per diode)

Symbol	Parameter			Value	Unit
V _{RRM}	Repetitive peak reverse voltage			60	V
I _{F(RMS)}	Forward rms current			30	A
I _{F(AV)}	Average forward current	T _C = 130 °C δ = 0.5	Per diode Per device	5 10	A
I _{FSM}	Surge non repetitive forward current	tp = 10 ms Sinusoidal		180	A
I _R RM	Repetitive peak reverse current	tp = 2 μs square F=1 kHz		1	A
P _{ARM}	Repetitive peak avalanche power	tp = 1 μs T _j = 25 °C		4000	W
T _{stg}	Storage temperature range			-65 to +175	°C
T _j	Maximum operating junction temperature ⁽¹⁾			150	°C
dV/dt	Critical rate of rise reverse voltage			10000	V/μs

1. $\frac{dP_{tot}}{dT_j} < \frac{1}{R_{th(j-a)}}$ thermal runaway condition for a diode on its own heatsink

Table 3. Thermal resistance

Symbol	Parameter		Value	Unit
R _{th(j-c)}	Junction to case	Per diode Total	4.5 3.5	°C/W
R _{th(c)}	Coupling		2.5	°C/W

When the diodes 1 and 2 are used simultaneously :

$$\Delta T_j(\text{diode 1}) = P(\text{diode1}) \times R_{th(j-c)}(\text{Per diode}) + P(\text{diode 2}) \times R_{th(c)}$$

Table 4. Static electrical characteristics (per diode)

Symbol	Parameter	Tests Conditions		Min.	Typ.	Max.	Unit
I _R ⁽¹⁾	Reverse leakage current	T _j = 25 °C	V _R = V _{RRM}			220	μA
		T _j = 125 °C			45	60	mA
V _F ⁽¹⁾	Forward voltage drop	T _j = 25 °C	I _F = 5 A			0.55	V
		T _j = 125 °C	I _F = 5 A		0.43	0.52	
		T _j = 25 °C	I _F = 10 A			0.67	
		T _j = 125 °C	I _F = 10 A		0.55	0.64	

1. Pulse test : tp = 380 μs, δ < 2%

To evaluate the conduction losses use the following equation:

$$P = 0.44 \times I_{F(AV)} + 0.0091 \times I_{F(RMS)}^2$$

STPS10L60C

Characteristics

Figure 1. Average forward power dissipation versus average forward current (per diode)

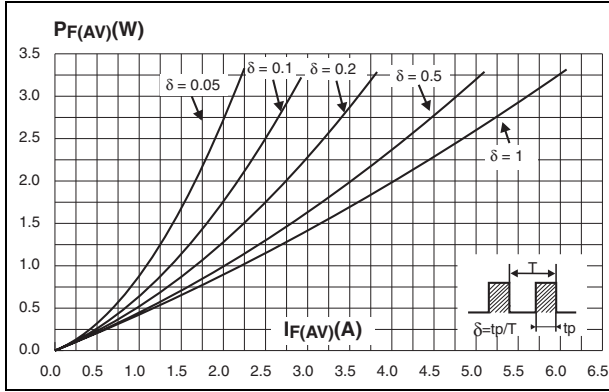

Figure 2. Average forward current versus ambient temperature ($\delta = 0.5$) (per diode)

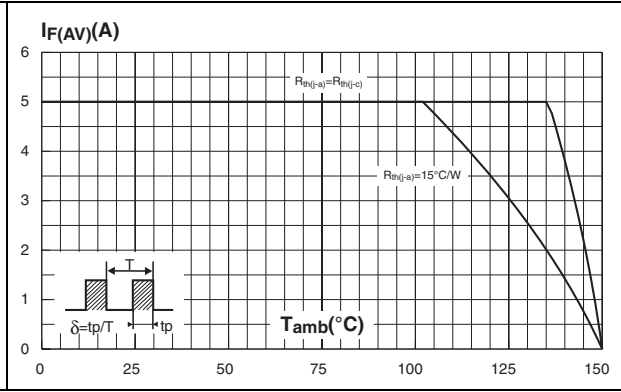

Figure 3. Normalized avalanche power derating versus pulse duration

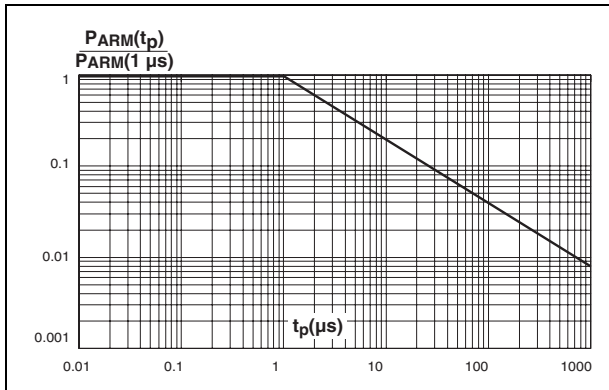

Figure 4. Normalized avalanche power derating junction temperature

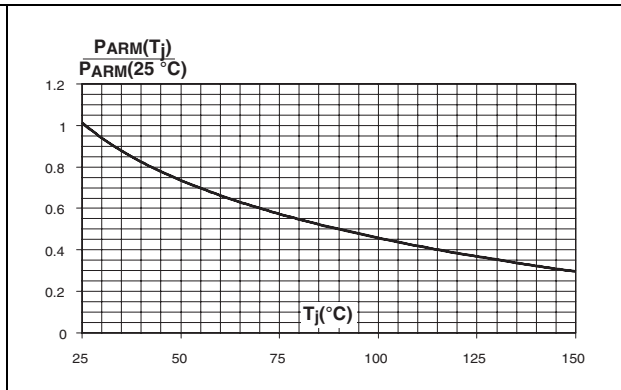

Figure 5. Non repetitive surge peak forward current versus overload duration (maximum values, per diode)

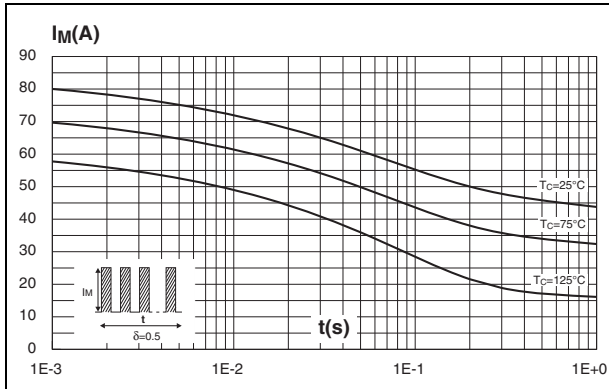
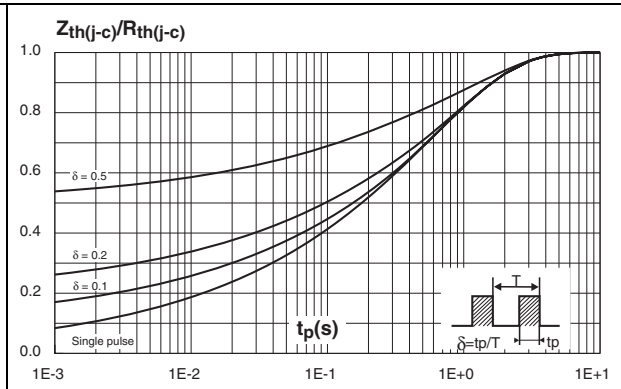

Figure 6. Relative variation of thermal transient impedance junction to case versus pulse duration



Characteristics

STPS10L60C

Figure 7. Reverse leakage current versus reverse voltage applied (typical values, per diode)

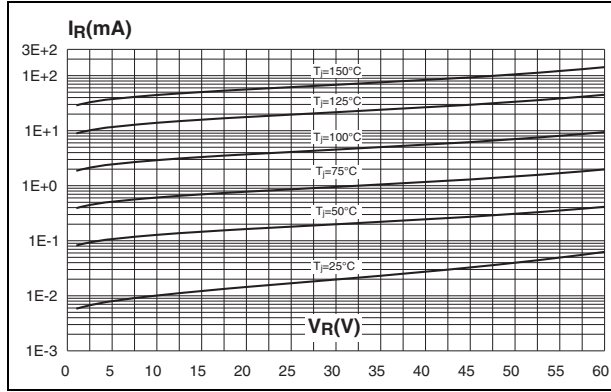

Figure 8. Junction capacitance versus reverse voltage applied (typical values, per diode)

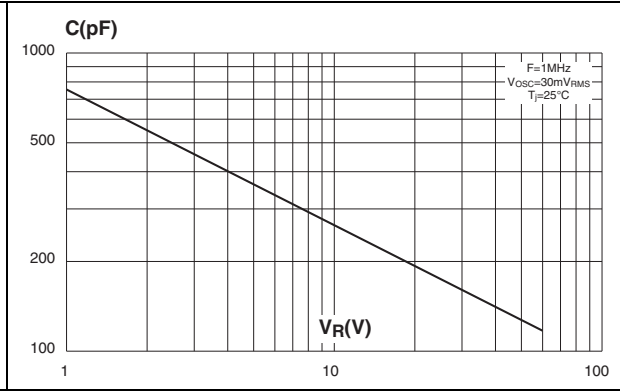
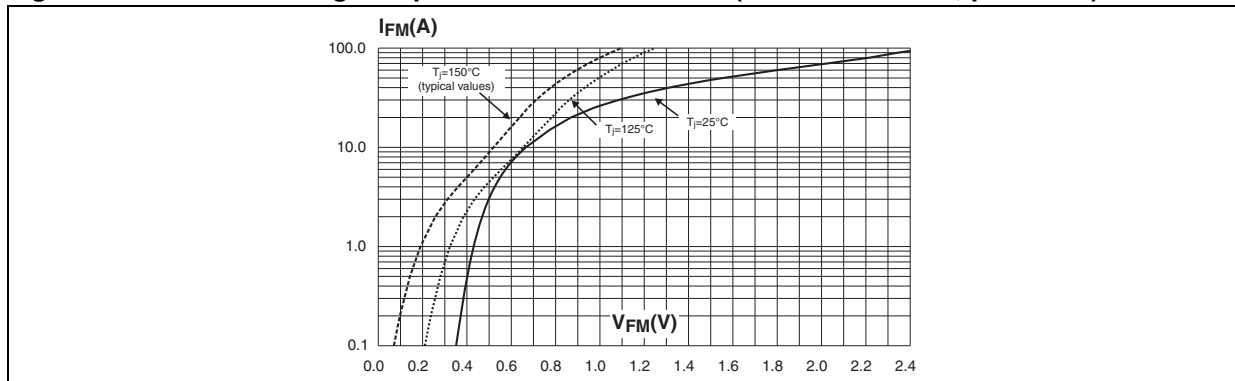

Figure 9. Forward voltage drop versus forward current (maximum values, per diode)



2 Package information

- Epoxy meets UL94, V0
- Cooling method: by conduction (C)
- Recommended torque value: 0.4 to 0.6 N·m

In order to meet environmental requirements, ST offers these devices in different grades of ECOPACK[®] packages, depending on their level of environmental compliance. ECOPACK[®] specifications, grade definitions and product status are available at: www.st.com. ECOPACK[®] is an ST trademark.

Table 5. TO-220FPAB Dimensions

Ref.	Dimensions			
	Millimeters		Inches	
	Min.	Max.	Min.	Max.
A	4.4	4.6	0.173	0.181
B	2.5	2.7	0.098	0.106
D	2.5	2.75	0.098	0.108
E	0.45	0.70	0.018	0.027
F	0.75	1	0.030	0.039
F1	1.15	1.70	0.045	0.067
F2	1.15	1.70	0.045	0.067
G	4.95	5.20	0.195	0.205
G1	2.4	2.7	0.094	0.106
H	10	10.4	0.393	0.409
L2	16 Typ.		0.63 Typ.	
L3	28.6	30.6	1.126	1.205
L4	9.8	10.6	0.386	0.417
L5	2.9	3.6	0.114	0.142
L6	15.9	16.4	0.626	0.646
L7	9.00	9.30	0.354	0.366
Dia.	3.00	3.20	0.118	0.126

Ordering information

STPS10L60C

3 Ordering information

Table 6. Ordering information

Order code	Marking	Package	Weight	Base qty	Delivery mode
STPS10L60CFP	STPS10L60CFP	TO-220FPAB	2 g	50	Tube

4 Revision history

Table 7. Document revision history

Date	Revision	Changes
Jul-2003	3C	Last release.
26-Mar-2007	4	Removed ISOWATT package. Added D ² PAK package.
04-May-2011	5	Removed D ² PAK package and updated graphic in Table 5 .

STPS10L60C

Please Read Carefully:

Information in this document is provided solely in connection with ST products. STMicroelectronics NV and its subsidiaries ("ST") reserve the right to make changes, corrections, modifications or improvements, to this document, and the products and services described herein at any time, without notice.

All ST products are sold pursuant to ST's terms and conditions of sale.

Purchasers are solely responsible for the choice, selection and use of the ST products and services described herein, and ST assumes no liability whatsoever relating to the choice, selection or use of the ST products and services described herein.

No license, express or implied, by estoppel or otherwise, to any intellectual property rights is granted under this document. If any part of this document refers to any third party products or services it shall not be deemed a license grant by ST for the use of such third party products or services, or any intellectual property contained therein or considered as a warranty covering the use in any manner whatsoever of such third party products or services or any intellectual property contained therein.

UNLESS OTHERWISE SET FORTH IN ST'S TERMS AND CONDITIONS OF SALE ST DISCLAIMS ANY EXPRESS OR IMPLIED WARRANTY WITH RESPECT TO THE USE AND/OR SALE OF ST PRODUCTS INCLUDING WITHOUT LIMITATION IMPLIED WARRANTIES OF MERCHANTABILITY, FITNESS FOR A PARTICULAR PURPOSE (AND THEIR EQUIVALENTS UNDER THE LAWS OF ANY JURISDICTION), OR INFRINGEMENT OF ANY PATENT, COPYRIGHT OR OTHER INTELLECTUAL PROPERTY RIGHT.

UNLESS EXPRESSLY APPROVED IN WRITING BY AN AUTHORIZED ST REPRESENTATIVE, ST PRODUCTS ARE NOT RECOMMENDED, AUTHORIZED OR WARRANTED FOR USE IN MILITARY, AIR CRAFT, SPACE, LIFE SAVING, OR LIFE SUSTAINING APPLICATIONS, NOR IN PRODUCTS OR SYSTEMS WHERE FAILURE OR MALFUNCTION MAY RESULT IN PERSONAL INJURY, DEATH, OR SEVERE PROPERTY OR ENVIRONMENTAL DAMAGE. ST PRODUCTS WHICH ARE NOT SPECIFIED AS "AUTOMOTIVE GRADE" MAY ONLY BE USED IN AUTOMOTIVE APPLICATIONS AT USER'S OWN RISK.

Resale of ST products with provisions different from the statements and/or technical features set forth in this document shall immediately void any warranty granted by ST for the ST product or service described herein and shall not create or extend in any manner whatsoever, any liability of ST.

ST and the ST logo are trademarks or registered trademarks of ST in various countries.

Information in this document supersedes and replaces all information previously supplied.

The ST logo is a registered trademark of STMicroelectronics. All other names are the property of their respective owners.

© 2011 STMicroelectronics - All rights reserved

STMicroelectronics group of companies

Australia - Belgium - Brazil - Canada - China - Czech Republic - Finland - France - Germany - Hong Kong - India - Israel - Italy - Japan - Malaysia - Malta - Morocco - Philippines - Singapore - Spain - Sweden - Switzerland - United Kingdom - United States of America

www.st.com