

Excellent Integrated System Limited

Stocking Distributor

Click to view price, real time Inventory, Delivery & Lifecycle Information:

[STMicroelectronics](#)
[STTH2006W](#)

For any questions, you can email us directly:

sales@integrated-circuit.com



STTH2006

Turbo 2 ultrafast high voltage rectifier

Main product characteristics

$I_{F(AV)}$	20 A
V_{RRM}	600 V
T_j	175° C
V_F (typ)	1.0 V
t_{rr} (max)	50 ns

Features and benefits

- Ultrafast switching
- Low reverse current
- Low thermal resistance
- Reduces switching and conduction losses

Description

The STTH2006 uses ST Turbo 2 600 V technology and is especially suited for use in switching power supplies, and industrial applications, such as rectification and continuous mode PFC boost diode.



Order Codes

Part Number	Marking
STTH2006W	STTH2006W

Table 1. Absolute Ratings (limiting values)

Symbol	Parameter	Value	Unit
V_{RRM}	Repetitive peak reverse voltage	600	V
$I_{F(RMS)}$	RMS forward current	50	A
$I_{F(AV)}$	Average forward current	$T_c = 120^\circ\text{C} \quad \delta = 0.5$	A
I_{FSM}	Surge non repetitive forward current	$t_p = 10\text{ ms sinusoidal}$	A
T_{stg}	Storage temperature range	-65 to + 175	° C
T_j	Maximum operating junction temperature	175	° C

1 Characteristics

Table 2. Thermal resistance

Symbol	Parameter	Value (max).	Unit
$R_{th(j-c)}$	Junction to case	1.1	°C/W

Table 3. Static electrical characteristic

Symbol	Parameter	Test conditions	Min.	Typ	Max.	Unit
I_R (1)	Reverse leakage current	$T_j = 25^\circ C$	$V_R = V_{RRM}$		25	μA
		$T_j = 150^\circ C$		80	800	
V_F (2)	Forward voltage drop	$T_j = 25^\circ C$	$I_F = 20 A$		1.75	V
		$T_j = 150^\circ C$		1.00	1.35	

1. Pulse test: $t_p = 5 ms$, $\delta < 2\%$

2. Pulse test: $t_p = 380 \mu s$, $\delta < 2\%$

To evaluate the conduction losses use the following equation:

$$P = 1.13 \times I_{F(AV)} + 0.011 I_{F(RMS)}^2$$

Table 4. Dynamic characteristics

Symbol	Parameter	Test conditions	Min.	Typ	Max.	Unit	
t_{rr}	Reverse recovery time	$T_j = 25^\circ C$	$I_F = 0.5 A$ $I_{rr} = 0.25 A$ $I_R = 1 A$			50	ns
			$I_F = 1 A$ $di_F/dt = -50 A/\mu s$ $V_R = 30 V$		50	70	
I_{RM}	Reverse recovery current	$T_j = 125^\circ C$	$I_F = 30 A$ $V_R = 400 V$ $di_F/dt = -100 A/\mu s$		8	11	A
t_{fr}	Forward recovery time	$T_j = 25^\circ C$	$I_F = 30 A$ $di_F/dt = 100 A/\mu s$ $V_{FR} = 1.1 \times V_{Fmax}$			500	ns
V_{FP}	Forward recovery voltage	$T_j = 25^\circ C$	$I_F = 30 A$ $di_F/dt = 100 A/\mu s$ $V_{FR} = 1.1 \times V_{Fmax}$		2.5		V

STTH2006

Characteristics

Figure 1. Conduction losses versus average forward current

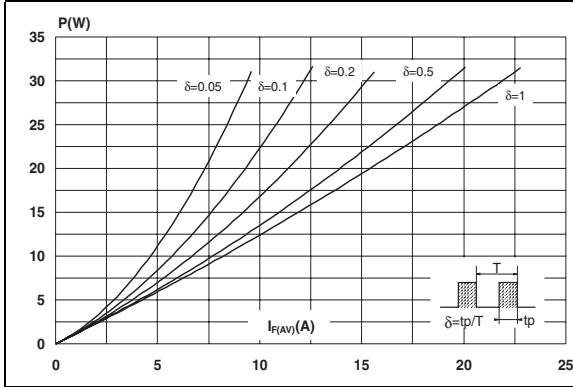

Figure 2. Forward voltage drop versus forward current

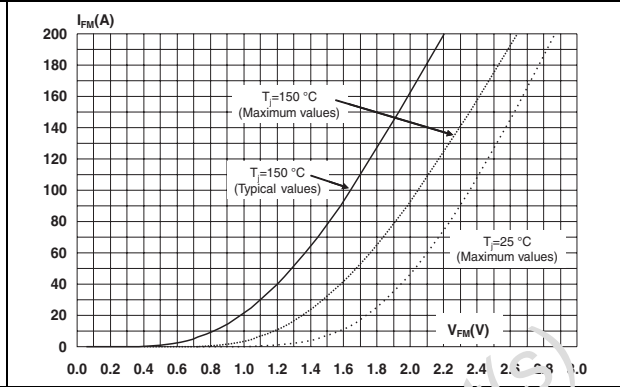

Figure 3. Relative variation of thermal impedance junction to case versus pulse duration

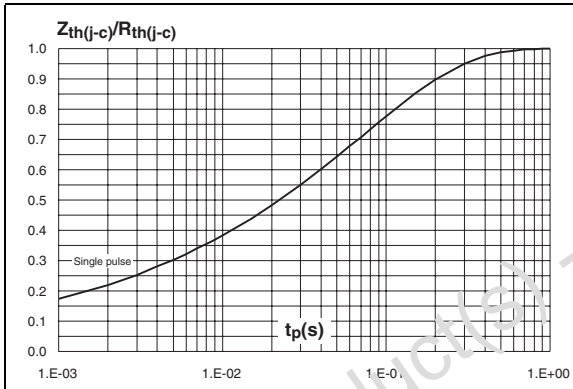

Figure 4. Peak reverse recovery current versus di_F/dt (typical values)

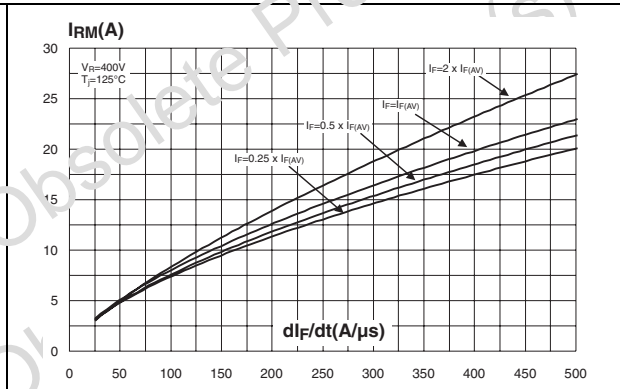

Figure 5. Reverse recovery time versus di_F/dt (typical values)

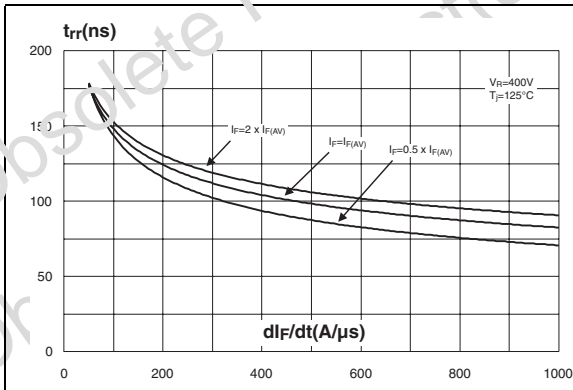
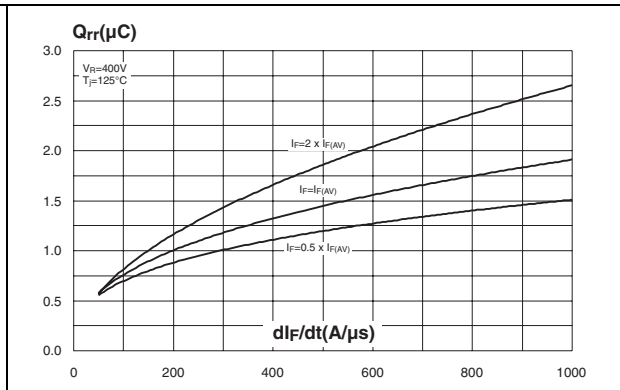

Figure 6. Reverse recovery charges versus di_F/dt (typical values)



Characteristics

STTH2006

Figure 7. Softness factor versus di_F/dt (typical values)

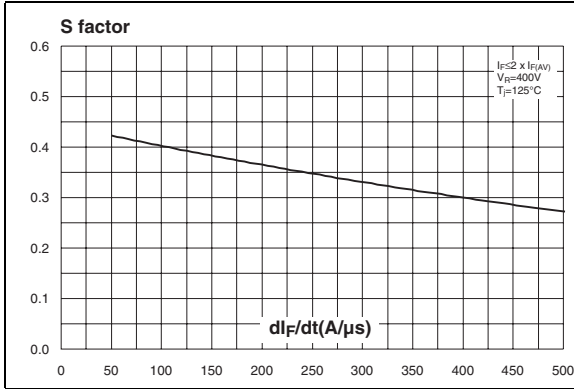

Figure 8. Relative variations of dynamic parameters versus junction temperature

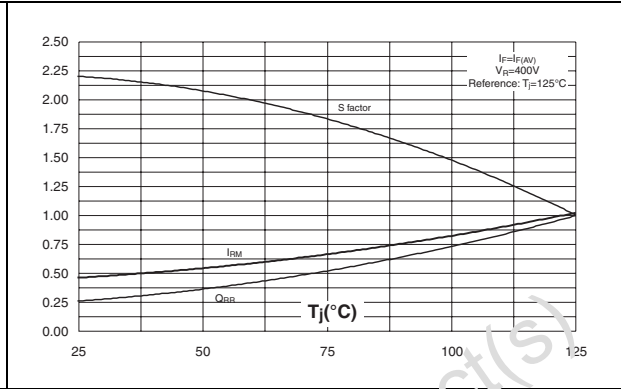

Figure 9. Transient peak forward voltage versus di_F/dt (typical values)

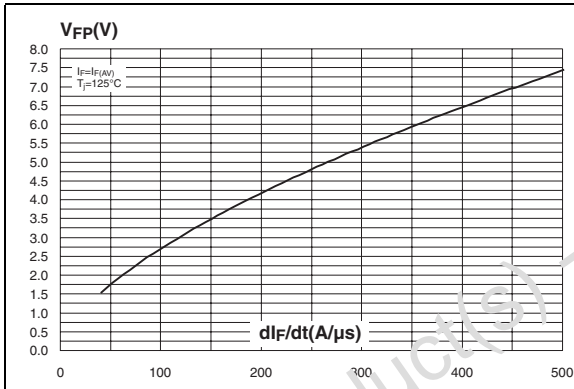

Figure 10. Forward recovery time versus di_F/dt (typical values)

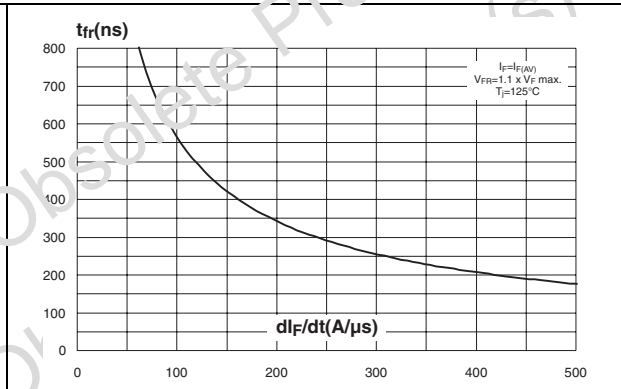
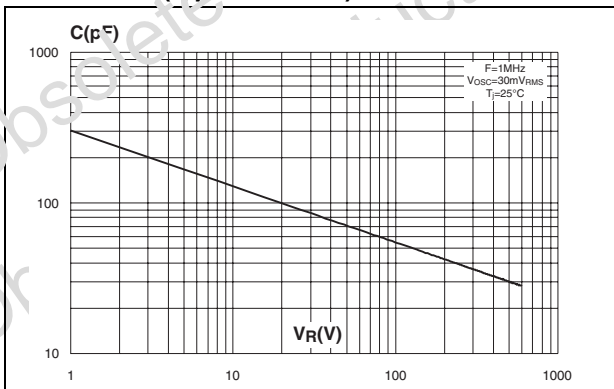

Figure 11. Junction capacitance versus reverse voltage applied (typical values)



2 Package information

- Epoxy meets UL94, V0
- Cooling method: by conduction (C)
- Recommended torque value: 0.55 Nm
- Maximum torque value: 0.70 Nm

Table 5. DO-247 Package dimensions

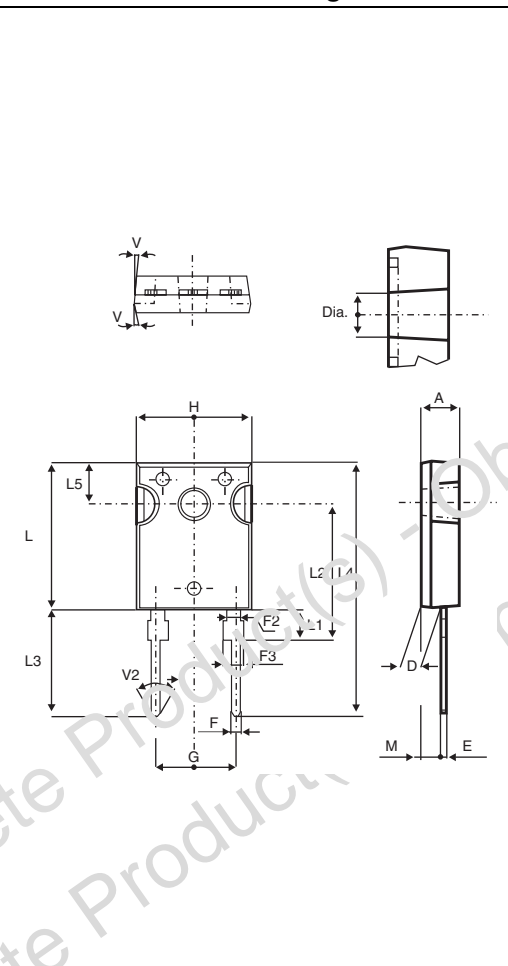

Ref.	Dimensions					
	Millimeters			Inches		
	Min.	Typ.	Max.	Min.	Typ.	Max.
A	4.85		5.15	0.191		0.203
D	2.20		2.60	0.086		0.102
E	0.40		0.80	0.015		0.031
F	1.00		1.40	0.039		0.055
F2		2.00			0.078	
F3		2.00	2.40		0.078	0.094
G		10.90			0.429	
H	15.45		15.75	0.608		0.620
L	19.85		20.15	0.781		0.793
L1	3.70		4.30	0.145		0.169
L2		18.50			0.728	
L3	14.20		14.80	0.559		0.582
L4		34.60			1.362	
L5		5.50			0.216	
M	2.00		3.00	0.078		0.118
V		5°			5°	
V2		60°			60°	
Dia.	3.55		3.65	0.139		0.143

In order to meet environmental requirements, ST offers these devices in ECOPACK® packages. These packages have a lead-free second level interconnect. The category of second level interconnect is marked on the package and on the inner box label, in compliance with JEDEC Standard JESD97. The maximum ratings related to soldering conditions are also marked on the inner box label. ECOPACK is an ST trademark. ECOPACK specifications are available at: www.st.com.

Ordering information

STTH2006

3 Ordering information

Ordering type	Marking	Package	Weight	Base qty	Delivery mode
STTH2006W	STTH2006W	DO-247	4.40 g	30	Tube

4 Revision history

Date	Revision	Changes
13-Jul-2006	1	Initial release.

Obsolete Product(s) - Obsolete Product(s)
 Obsolete Product(s) - Obsolete Product(s)

STTH2006

Please Read Carefully:

Information in this document is provided solely in connection with ST products. STMicroelectronics NV and its subsidiaries ("ST") reserve the right to make changes, corrections, modifications or improvements, to this document, and the products and services described herein at any time, without notice.

All ST products are sold pursuant to ST's terms and conditions of sale.

Purchasers are solely responsible for the choice, selection and use of the ST products and services described herein, and ST assumes no liability whatsoever relating to the choice, selection or use of the ST products and services described herein.

No license, express or implied, by estoppel or otherwise, to any intellectual property rights is granted under this document. If any part of this document refers to any third party products or services it shall not be deemed a license grant by ST for the use of such third party products or services, or any intellectual property contained therein or considered as a warranty covering the use in any manner whatsoever of such third party products or services or any intellectual property contained therein.

UNLESS OTHERWISE SET FORTH IN ST'S TERMS AND CONDITIONS OF SALE ST DISCLAIMS ANY EXPRESS OR IMPLIED WARRANTY WITH RESPECT TO THE USE AND/OR SALE OF ST PRODUCTS INCLUDING WITHOUT LIMITATION IMPLIED WARRANTIES OF MERCHANTABILITY, FITNESS FOR A PARTICULAR PURPOSE (AND THEIR EQUIVALENTS UNDER THE LAWS OF ANY JURISDICTION), OR INFRINGEMENT OF ANY PATENT, COPYRIGHT OR OTHER INTELLECTUAL PROPERTY RIGHT.

UNLESS EXPRESSLY APPROVED IN WRITING BY AN AUTHORIZED ST REPRESENTATIVE, ST PRODUCTS ARE NOT RECOMMENDED, AUTHORIZED OR WARRANTED FOR USE IN MILITARY, AIR CRAFT, SPACE, LIFE SAVING, OR LIFE SUSTAINING APPLICATIONS, NOR IN PRODUCTS OR SYSTEMS WHERE FAILURE OR MALFUNCTION MAY RESULT IN PERSONAL INJURY, DEATH, OR SEVERE PROPERTY OR ENVIRONMENTAL DAMAGE. ST PRODUCTS WHICH ARE NOT SPECIFIED AS "AUTOMOTIVE GRADE" MAY ONLY BE USED IN AUTOMOTIVE APPLICATIONS AT USER'S OWN RISK.

Resale of ST products with provisions different from the statements and/or technical features set forth in this document shall immediately void any warranty granted by ST for the ST product or service described herein and shall not create or extend in any manner whatsoever, any liability of ST.

ST and the ST logo are trademarks or registered trademarks of ST in various countries.

Information in this document supersedes and replaces all information previously supplied.

The ST logo is a registered trademark of STMicroelectronics. All other names are the property of their respective owners.

© 2006 STMicroelectronics - All rights reserved

STMicroelectronics group of companies

Australia - Belgium - Brazil - Canada - China - Czech Republic - Finland - France - Germany - Hong Kong - India - Israel - Italy - Japan - Malaysia - Malta - Morocco - Singapore - Spain - Sweden - Switzerland - United Kingdom - United States of America

www.st.com