

Excellent Integrated System Limited

Stocking Distributor

Click to view price, real time Inventory, Delivery & Lifecycle Information:

[STMicroelectronics](#)
[ST7MDTU5-EMU2B](#)

For any questions, you can email us directly:

sales@integrated-circuit.com

ST7MDTU5-EMU2B HDS2 Series Emulator User Manual

Release 1.4

June 2002



Ref: DOC-ST7MDTU5-EMU2B



INSTRUCTIONS FOR USE—WARNING

This product is conform to the 89/336/EEC Directive. It complies with the ITE EN55022 standard for EMC emissions and generic 50082-1 (1992 edition) immunity standards.

This product is an FCC Class-A apparatus. In a residential environment, it may cause radioelectrical disturbances.

In addition, some parts of this emulator are not contained in an outer casing; consequently, it cannot be immune against electrostatic discharges (ESD). It should therefore be handled only in static safe working areas. Please refer to [Appendix A: EMC Conformity and Safety Requirements](#) on page 57 for relevant safety information.

USE IN LIFE SUPPORT DEVICES OR SYSTEMS MUST BE EXPRESSLY AUTHORIZED.

STMicroelectronics PRODUCTS ARE NOT AUTHORIZED FOR USE AS CRITICAL COMPONENTS IN LIFE SUPPORT DEVICES OR SYSTEMS WITHOUT THE EXPRESS WRITTEN APPROVAL OF STMicroelectronics. As used herein:

1. Life support devices or systems are those which (a) are intended for surgical implant into the body, or (b) support or sustain life, and whose failure to perform, when properly used in accordance with instructions for use provided with the product, can be reasonably expected to result in significant injury to the user.
2. A critical component is any component of a life support device or system whose failure to perform can reasonably be expected to cause the failure of the life support device or system, or to affect its safety or effectiveness.

Table of Contents

Chapter 1:	Introduction	5
1.1	Emulator configuration	6
1.2	Emulator operation	7
1.3	Software and documentation for the emulator kit	8
1.4	About this manual.....	8
1.5	Getting assistance	9
Chapter 2:	Getting Started	11
2.1	Your system requirements	11
2.2	Delivery checklist	11
2.3	Installing the hardware	13
2.4	Debuggers supporting the ST7 HDS2 emulator	19
Chapter 3:	STVD7	21
3.1	Installing STVD7	21
3.2	Launching STVD7	22
3.3	About STVD7 debugging features	23
3.4	Workspaces	24
3.5	Toolchains and application files	25
3.6	Creating a workspace	28
3.7	Opening an existing workspace	30
3.8	Opening files directly for debugging (*.abs, *.s19, *.hex and *.elf)	33
3.9	Opening lone programmable files (*.s19 or *.hex)	34
3.10	Changing your project settings	35
3.11	Saving workspaces	37
3.12	Debug context and Build context	39
3.13	Configuring the MCU	40
3.14	Start debugging!	45
Chapter 4:	Emulator Features	47
4.1	Main features of the ST7 HDS2 emulator series	47
4.2	Specific features	47
4.3	Emulator architecture	48
4.4	Output triggers	51
4.5	Analyser probe input signals	53
4.6	Front panel LEDs	54
4.7	On-chip peripherals	55

Table of Contents

4.8	Emulation functional limitations and discrepancies	55
Appendix A: EMC Conformity and Safety Requirements		57
Appendix B: Troubleshooting		59
B.1	Identifying the problem	59
B.2	Changing the parallel port setup on your PC	59
B.3	Running the hardware test	60
Appendix C: Glossary		63
Product Support		65
	Getting prepared before you call.....	65
	Contact list	65
	Software updates	66
	Hardware spare parts	66
Index		69

1 INTRODUCTION

Thanks for choosing ST7! This manual will help you get started with the ST7MDTU5-EMU2B emulator kit.

The ST7MDTU5-EMU2B emulator allows you to control the execution of programs that you have written for the ST7265x family of MCUs (see list below) and assists you in debugging your application hardware as well as your software. The ST7MDTU5-EMU2B kit comes with the debugger software package—ST7 Visual Debug—which contains all of the necessary resources to help you design, develop and debug ST7 application software running in a real environment.

Note: If you come across any terms or abbreviations you do not understand, you can check their meaning in the [Glossary](#) on page 63.

First off, check that the ST7 MCU that you have picked for your application is in the list of devices supported by this version of the ST7MDTU5-EMU2B emulator:

Supported Devices

ST72651

ST72F651

ST72652

ST72F652

The Emulator Package is made up of two main parts:

- The Hardware Development System (**ST7 HDS2**), which is the common mainframe to all ST7 emulators.
- The **ST7MDTU5-Active Probe**, dedicated to the family, which constitutes the physical link between the emulator and your application.

Note: When receiving the ST7MDTU5-EMU2B development tool, please refer to the [Delivery checklist](#) on page 11 to confirm that all of the contents of the package are present.

The emulator performs two main functions:

- It replaces the microcontroller in the application, by means of an emulation probe that is plugged into the application in place of the emulated MCU.
- It controls the internal data bus of the emulated microcontroller, providing arbitration and tracing capabilities on all accesses to any of the following resources:

1 - Introduction

ST7MDTU5-EMU2B User Manual

- ST7 HDS2 resources,
- ST7MDTU5-Active Probe resources,
- Application resources.

Therefore, you can have the emulator running your software in the application just as the emulated MCU would do, and have extensive tracing and control capabilities (i.e. keeping track of what the MCU does, and making it react in a specific way upon defined conditions).

In this way, it is possible to fully emulate microcontroller resources.

Please refer to [Section 4.8: Emulation functional limitations and discrepancies](#) on page 55 for a description of the limitations on the current release of this emulator kit.

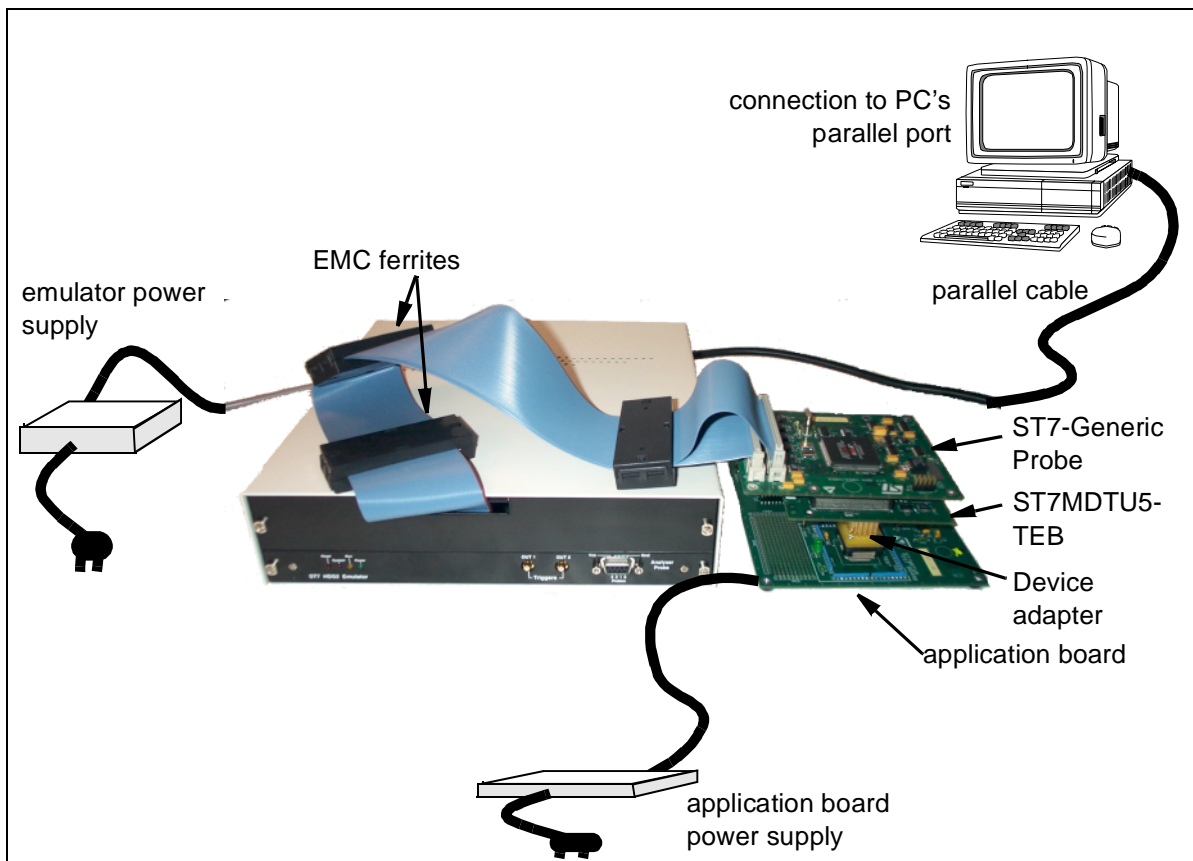

Figure 1: ST7MDTU5-EMU2B general configuration

1.1 Emulator configuration

Figure 1 shows the configuration for the ST7MDTU5-EMU2B emulator kit. The main ST7 HDS2 box is connected to your PC via the parallel port. Two flat cables connect the ST7 HDS2 box to the ST7MDTU5-Active Probe. The ST7 Generic

Probe is connected to the ST7MDTU5-TEB, to which a device adapter can be fixed so that you can connect the emulator to your application board.

The emulator is operated from your host PC using **STVD7**, a state-of-the-art, **integrated development environment**, from which you can configure and control the emulator, debug, edit and rebuild your application program.

1.2 Emulator operation

The emulator is controlled using **STVD7**, (also referred to as **ST7 Visual Debug**). STVD7 integrates all phases of an application development in a single, powerful and easy to use environment.

The graphical interface is composed of one main window which consists of an integrated set of windows, menus, toolbars and other elements that allow the user to create, build, debug and refine an application using a single tool. The visual environment can be personalized; the user can change the position of all windows, open or close individual elements, alter which windows are visible at startup, and save the configuration. User-defined toolbars may be created, and command icons added or removed from toolbars. The integrated syntax-color highlighting editor allows several source files to be edited in a single place.

Thanks to the powerful features of the debugger, the debugging and tuning of an application is made easier and quicker. Debugging with STVD7 (with an ST7 HDS2 emulator) involves the following functional aspects:

- Loading the application.
- Defining the memory map and option configuration of the target MCU.
- Running the application.
- Viewing source and disassembled code.
- Setting instruction breakpoints.
- Setting data breakpoints.
- Using the Logical Analyser to impose counters and conditions on breakpoints and trace recording.
- Viewing variables, memory and registers.
- Viewing history of execution: trace (up to 1024 records) and call stack features.

Chapter 3: STVD7 on page 21, explains how to install ST7 Visual Debug on your PC, and set up the emulator configuration so that you can begin your debugging session.

When your application is fully debugged, the ST7 EPROM programming board (ref.: ST7MDTU5-EPB — not provided with this emulator kit) can be used to

program the emulation device with the Motorola S Record format file produced by the OBSEND formatter.

1.3 Software and documentation for the emulator kit

The “MCU on CD” CD-ROM contains:

- ST7 Tools, comprising the following software:
 - The source-level graphic debugger, STVD7, that operates with ST7-HDS2 Emulators, other hardware targets or as a standalone ST7 simulator.
 - The ST7 Assembler toolchain, composed of an assembler, linker, librarian and formatter.
 - The ST7 Windows Epromer to program your MCU target devices.
- Third-party C compiler and toolchain demos (Hiware and Cosmic).
- *ST7 Assembler-Linker User Manual* and the *ST7 Programming Manual* (available in Adobe Acrobat PDF format).
- *STVD7 User Manual* (available in Adobe Acrobat PDF).
- ST7 application notes (with sources), training slides and exercises, this manual (in PDF version), and other useful reference materials.
- Datasheets for ST7 MCUs are available individually in Adobe Acrobat PDF format.

1.4 About this manual....

Detailed instructions on how to install your emulator configuration are described in [Chapter 2: Getting Started](#) on page 11.

How to start debugging your application using your emulator and ST7 Visual Debug is described in [Chapter 3: STVD7](#) on page 21.

The emulator kit's hardware features are described in [Chapter 4: Emulator Features](#) on page 43.

The following conventions are used in this manual:

Bold text highlights key terms, phrases and is used when referring to names of dialog boxes, windows and tabs within windows.

Bold italic text denotes menu commands (or sequence of commands), options, buttons or checkboxes which you must click in order to perform an action.

Italicized text highlights document names, variable strings, column names and field names.

Code font designates file names, programming commands, path names and any text you must type.

The > symbol is used in a sequence of commands to mean “then”. For example, to open an application in Windows, we would write: “Click **Start>Programs>ST7 Tool Chain>....**”.

1.5 Getting assistance

For more information, application notes, FAQs and software updates on all the ST microcontroller families, check out the CD-ROM or our website:

<http://mcu.st.com>

For assistance on all ST microcontroller subjects, or if you need help with using your emulator, use the contact list provided in [Contact list](#) on page 65. We'll be glad to help you!

2 GETTING STARTED

2.1 Your system requirements

The ST7MDTU5-EMU2B HDS2 Emulator (both hardware and software components) has been designed to work with PCs meeting the following requirements:

- One of the following operating systems: Microsoft[®] Windows[®] 95, 98, 2000 or NT[®].
- Intel[®] Pentium (or compatible) processor with minimum speed of 133 MHz.
- Minimum RAM of 32 MB (64 MB recommended).
- 50 MB of free hard disk space to install all of the ST7 tools.

2.2 Delivery checklist

The emulator kit (ref.: ST7MDTU5-EMU2B), is delivered with the following (refer to [Figure 2](#)):

- 1 One emulator box containing the ST7 HDS2 main board (ref.: MB176) and two 50-wire flat cables to connect the ST7 HDS2 main board to the generic emulation probe.
- 2 One emulator power supply.
- 3 One parallel cable.
- 4 Two SMB to BNC trigger cables.
- 5 One analyser probe cable.
- 6 A TQFP64 (14 x 14) device adapter (ref.: DB474A) and TET socket (ref.: TET 064SA).
- 7 One generic emulation probe—the ST7 Generic Probe (ref.: DB467).
- 8 An ST7MDTU5-Target Emulation Board (TEB) (ref.: DB473).
- 9 Three EMC ferrite clips.
- 10 A TQFP64-0.8 (10 x 10) socket (ref.: TET 064SA) and cover, for soldering to your application board.
- 11 A 20 cm TQFP64 (10 x 10) flex cable (ref.: DB520) with two 40-pin connectors, for connection between the emulation probe and your application board. Used with (10).

2 - Getting Started

ST7MDTU5-EMU2B User Manual

12 The following documentation and software (not shown):

- This manual.
- A CD-ROM containing ST7 software and documentation, including ST7 Visual Debug, the ST7 Assembler Toolchain and a Windows® Epromer.

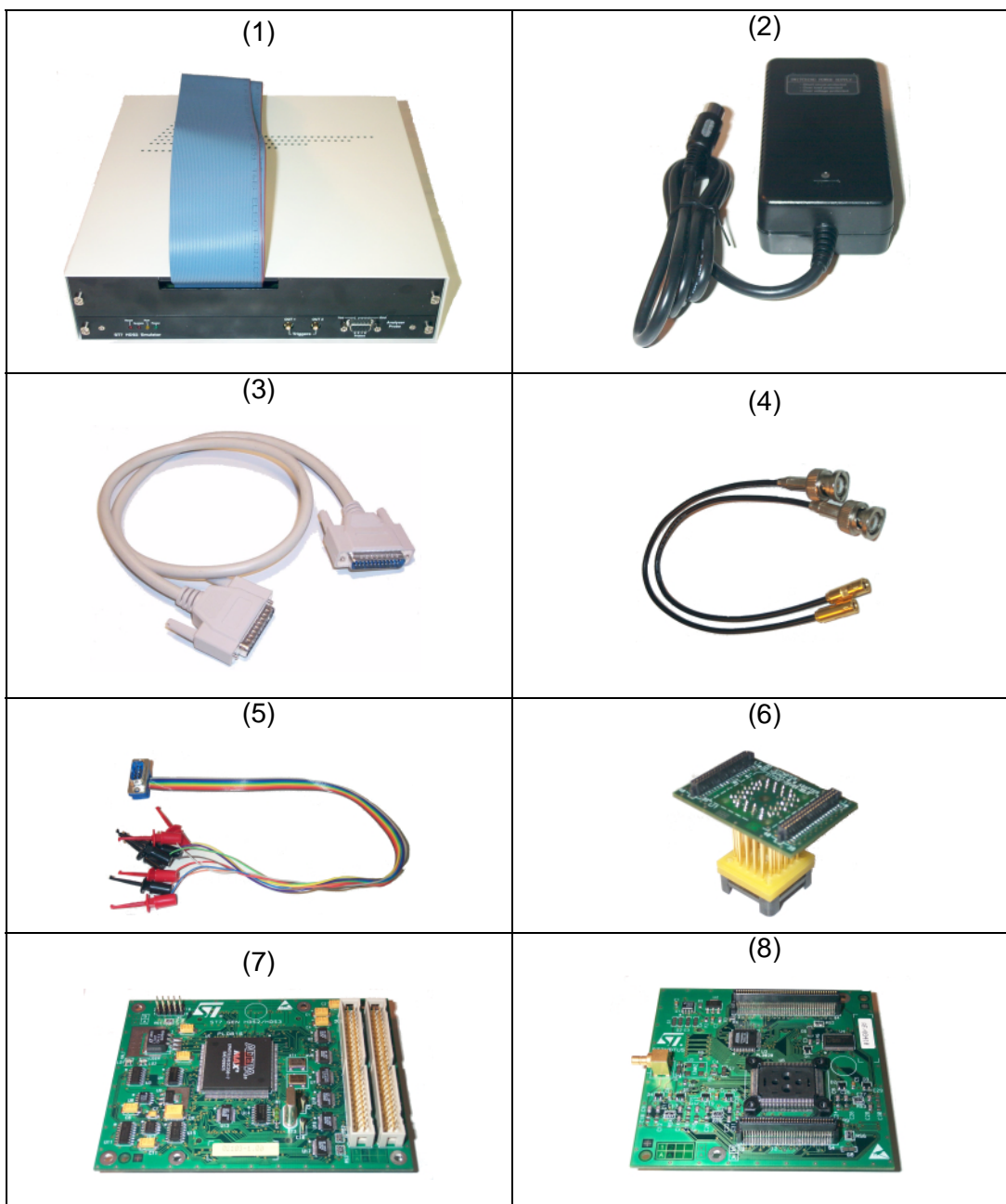

Figure 2: Main components of ST7MDTU5-EMU2B emulator kit

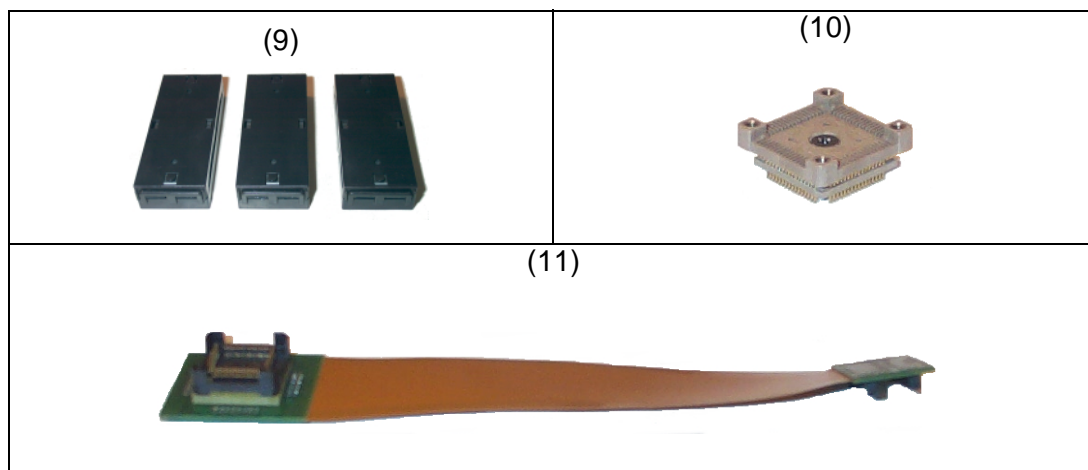

Figure 2: Main components of ST7MDTU5-EMU2B emulator kit

2.3 Installing the hardware

The ST7 HDS2 emulator is connected through the parallel port to a PC computer which runs the control software (ST7 Visual Debug) as explained later. To connect your ST7 HDS2 emulator, you will have to follow these general steps (explained in detail later):

- 1 Connect the ST7 HDS2 emulator to your PC using the parallel cable provided.
- 2 Connect the two flat cables of your ST7 HDS2 emulator to the emulation probe connectors.
- 3 Connect the probe to the application board using device adapters or flex cable.
- 4 Connect the power supply cable between the power supply block and the power connector located on the rear panel of your ST7 HDS2 emulator.
- 5 Power up the emulator and then connect your application power supply.

A connection flow diagram is shown in [Figure 3](#). Each installation step is described in detail in the following sections.

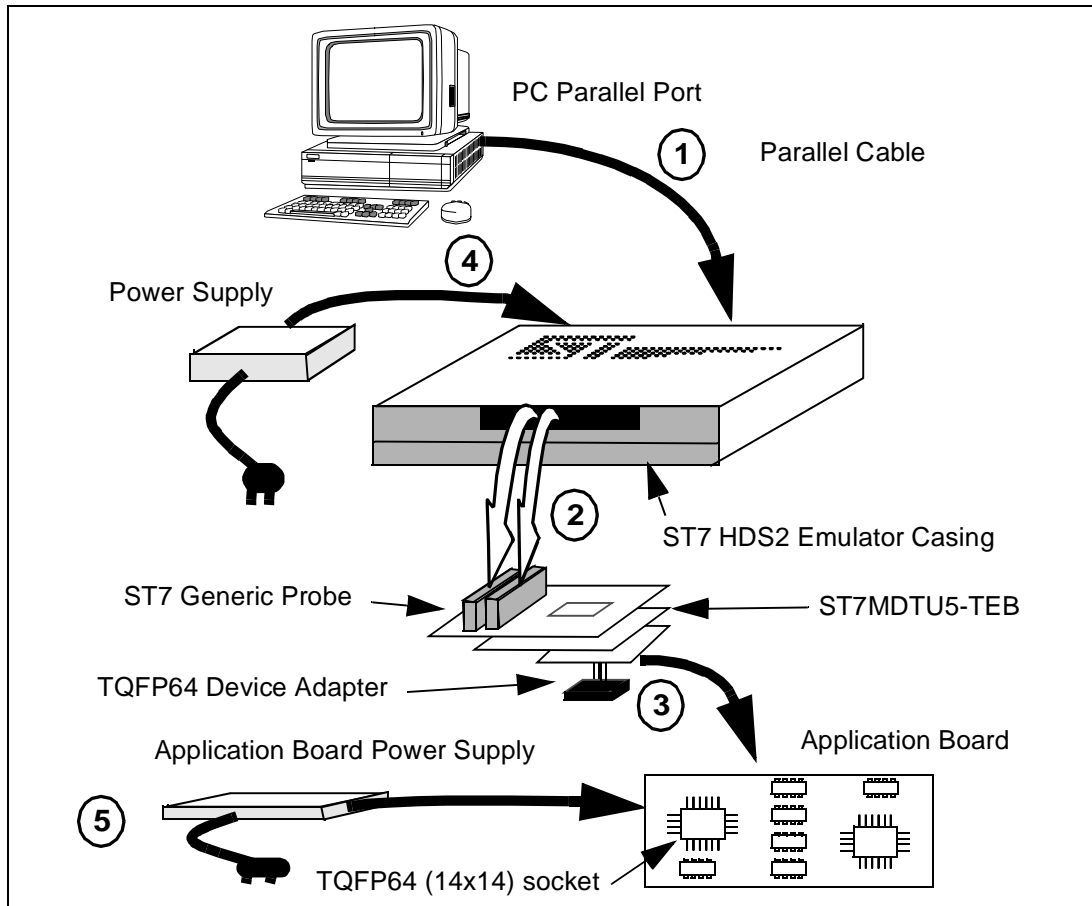

Figure 3: ST7MDTU5-EMU2B connection flow

2.3.1 Step 1: Connecting the emulator to your PC

- 1 Shutdown and power-off the PC that is to be connected to the emulator.
- 2 Connect one end of the parallel cable to the emulator's rear panel 25-pin SUB-D connector and the other end to one of the PC's parallel ports (LPT1 to LPT2)—refer to [Figure 4](#).

Note: Be sure to use the parallel cable provided with the emulator—using a longer parallel cable may cause emulator malfunctions.

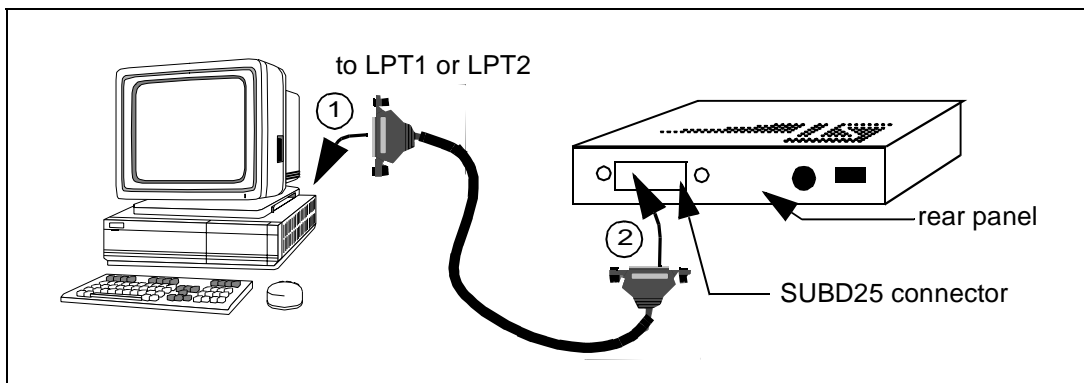

Figure 4: Connecting the emulator to the PC

2.3.2 Step 2: Connecting the emulator to the probe

- 1 Ensure that the application and the emulator are **powered-off**.
- 2 Plug the two 50-wire flat cables into the J1 and J2 connections on the probe, as described below (refer also to [Figure 5](#)):

ST7-HDS2 Emulator (ref.: MB176)	ST7 Generic Probe (ref.: DB467)
Upper cable	J2
Lower cable	J1

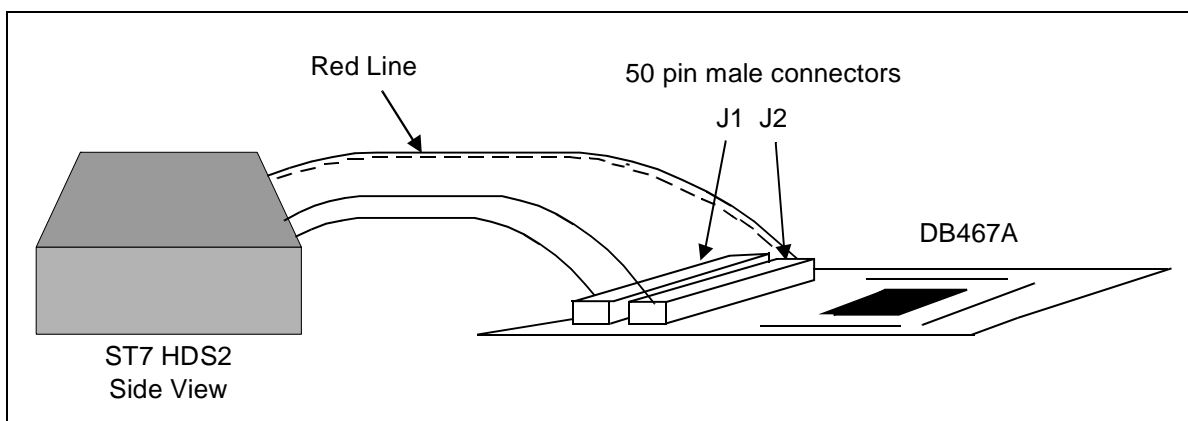

Figure 5: Connecting the emulator to the generic probe

EMC-compliant probes: In order to work under an EMC-compliant environment, clip the three EMC ferrites onto the 50-wire flat cables linking the probe to the

2 - Getting Started

ST7MDTU5-EMU2B User Manual

emulator box. Place these ferrites as close to the emulator window as possible. Three ferrites are provided in the package. See *Figure 6* for an illustration of where to attach the ferrites.

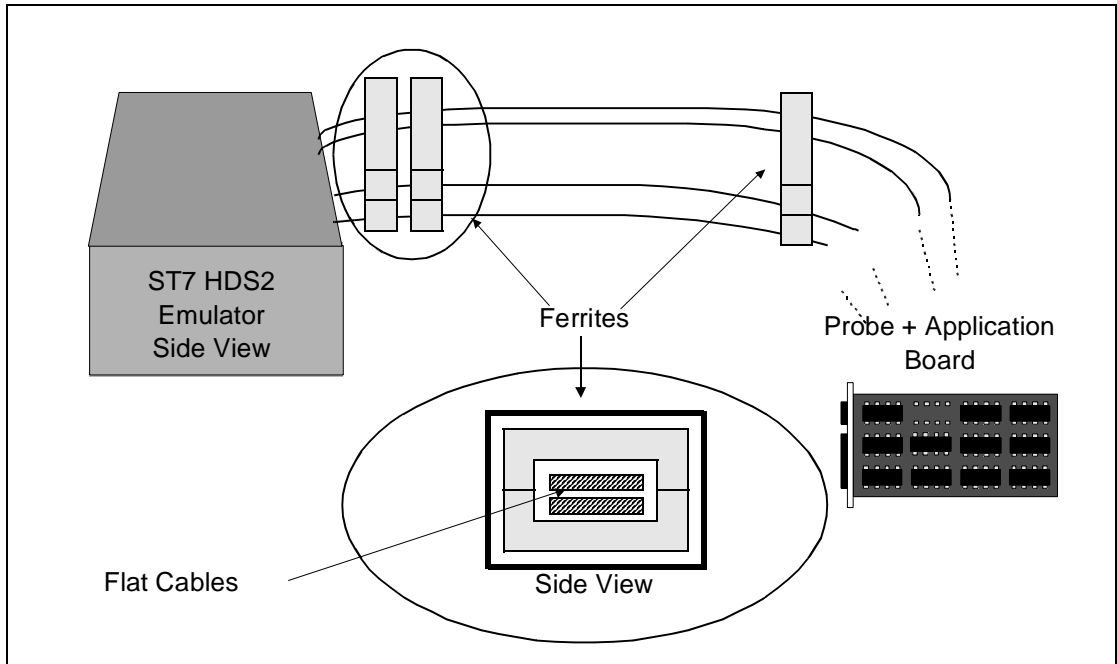

Figure 6: Making your probes EMC-compliant

2.3.3 Step 3: Connecting the probe to your application board

If you are using the TQFP64 14x14 package, proceed as follows (see [Figure 7](#)):

For the TQFP64 14 x 14 package, you must assemble the ST7MDTU5-Active Probe, which is made up of a generic ST7 emulation probe connected to a Target Emulation Board, which is in turn connected to a TQFP64 (14 x 14) device adapter.

- 1 Solder the TET socket base (ref.: TET 064SA) of the TQFP64 device adapter onto your application board.

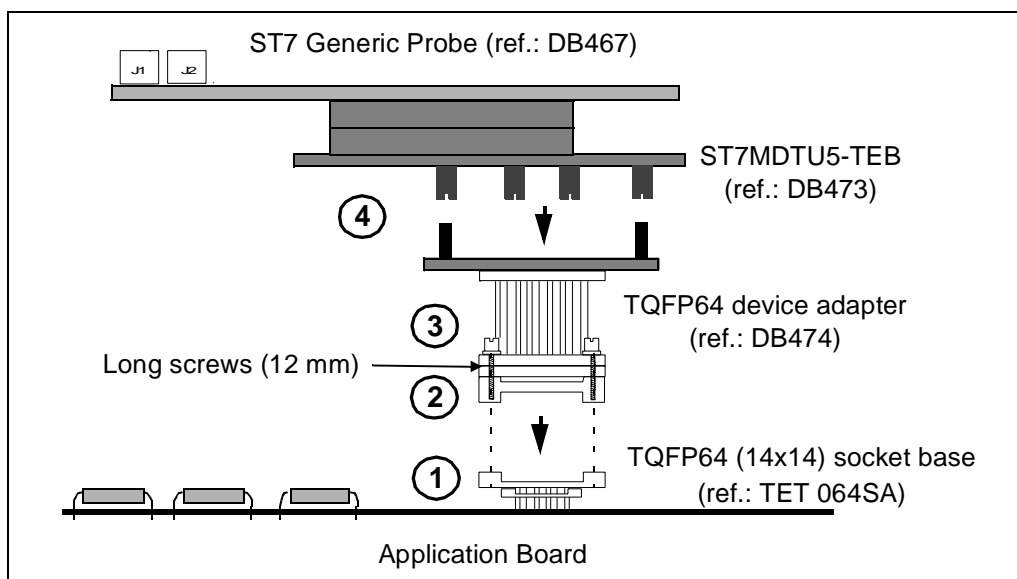

Figure 7: TQFP64 (14x14) MCU package connections

- 2 Place the TQFP64 device adapter (ref.: DB474A) upon the TET socket base, aligning pin 1 of the device adapter with pin 1 on your application board's socket. (On the TQFP64 device adapter, pin 1 is indicated by a chamfer on the adapter base.)
- 3 Once in place, screw the TQFP64 adapter and the TET socket base together.
- 4 Now connect the joined ST7 Generic Probe (ref.: DB467A) and ST7MDTU5-TEB (ref.: DB473A) to the TQFP64 adapter, by inserting the female pins of the adapter into the male connectors on the underside of the ST7MDTU5-TEB.

Note: You can use your emulator kit with ST7 Visual Debug without an application board—however the emulation probes must be connected to the HDS2 emulator.

If you are using the TQFP64 10 x 10 package, proceed as follows (see [Figure 8](#)):

To connect the ST7MDTU5-Active Probe to your application board, a TQFP64 flex cable and a TQFP64-0.8 socket base have been provided.

- 1 Solder the TQFP64-0.8 socket base (ref.: TET 064SA) onto your application board. Do not use the socket cover (set it aside for future use with an actual MCU).

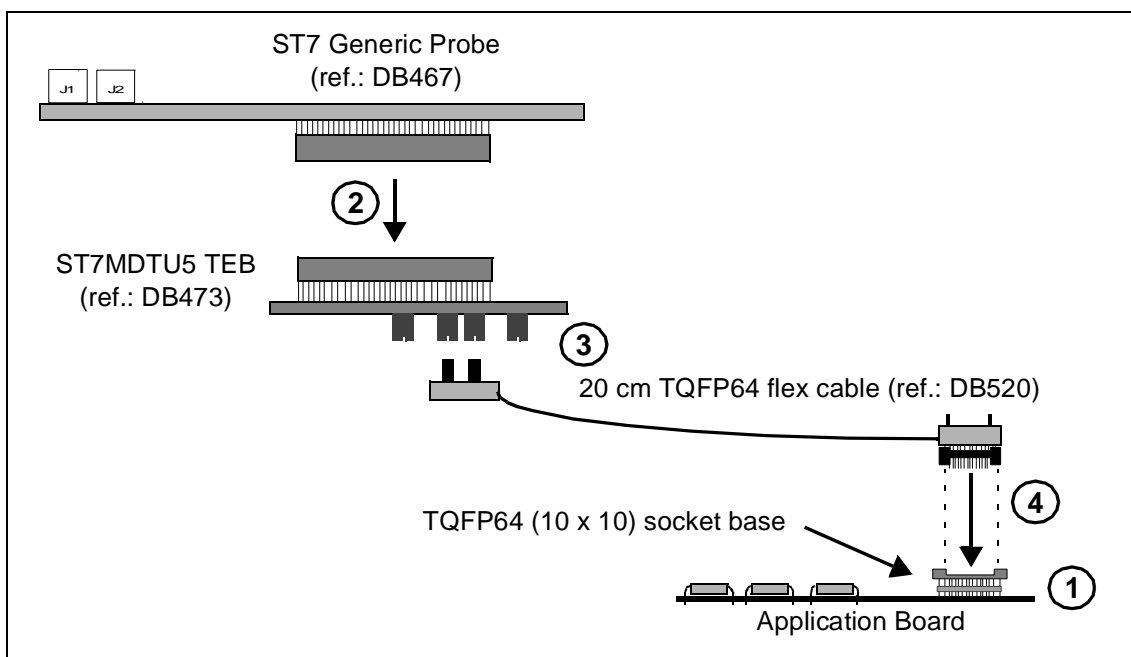

Figure 8: TQFP64 MCU package connections

- 2 Connect the ST7 Generic Probe (ref.: DB467) to the ST7MDTU5 TEB (ref.: DB473).
- 3 Connect the two 40-pin connectors of the 20 cm TQFP64 flex cable (ref.: DB520) to the two 40-pin connectors (labelled QFP64 FLEX ADAPTER) on the underside of the ST7MDTU5 TEB (ref.: DB473), taking care to align pin 1 on each flex cable connector with the pin 1 on each TEB connector.
- 4 Connect the TQFP64 flex cable end to the TQFP64 socket base, making sure to align pin 1 on the TQFP64 flex connector with pin 1 on the socket base. (Pin 1 is indicated by a chamfer on the TQFP64 flex connector and by a little arrow or chamfer on the socket base.)
- 5 Now use the four screws supplied to fasten this entire assembly together through the holes located on the TQFP64 flex cable connector as indicated in [Figure 8](#).

2.3.4 Step 4: Connecting the emulator power supply

Note: Make sure that both the ST7MDTU5-EMU2B and the application are **OFF** before making **any connections**.

- 1 Connect the external power supply provided with the emulator to the rear panel of the mainframe using a 5-pin DIN connector.
- 2 Plug the power supply into the mains using the supply cable provided.

Mains Voltage Specifications

AC Voltage	100 V to 240 V
Frequency	50 Hz to 60 Hz

2.3.5 Step 5: Powering up

- 1 Check the ST7 HDS2 operating voltage (110 V/220 V) indicated on the label on the power supply. Contact your dealer if this voltage does not correspond to your mains' power supply.
- 2 Power up the ST7 HDS2 emulator from the ON/OFF switch located on the rear panel. The LED labelled **Power** on the front panel should then light up.
- 3 Power up your application.

2.4 Debuggers supporting the ST7 HDS2 emulator

STVD7 is the STMicroelectronics debugger currently supporting the ST7 HDS2 emulator. How to install and start using it is described in [Chapter 3 on page 21](#).

STVD7 is a free software package, provided on the *MCU on CD* CD-ROM supplied with your emulator. Regularly updated versions are also available from the STMicroelectronics website (see the section entitled [Software updates](#) on page 66 for more information).

Third party debuggers supporting the ST7 HDS2 emulator include the following:

- *ST7-Hiwave* by **HIWARE**
- *Zap* by **COSMIC**
- *Hitop* by **HITEX**.

3 STVD7

STVD7 is an integrated development environment that allows you to edit, debug and rebuild your application all from within STVD7.

The following sections tell you:

- [Section 3.1](#)—how to install the STVD7 software,
- [Section 3.2](#)—how to launch STVD7,
- [Section 3.3](#)—a little about STVD7’s debugging features,
- [Section 3.4](#)—what a workspace is,
- [Section 3.5](#)—what toolchains and executable files are supported by STVD7,
- [Section 3.6](#)—how to create a STVD7 workspace,
- [Section 3.7](#)—how to open existing workspaces,
- [Section 3.8](#)—how to open binary files,
- [Section 3.10](#)—how to change your project settings,
- [Section 3.11](#)—how to save workspaces,
- [Section 3.12](#)—how to switch from the build context to the debug context,
- [Section 3.13](#)—how to configure the target MCU in order to debug more accurately and efficiently.

3.1 Installing STVD7

Your emulator comes with the “MCU on CD” CD-ROM which contains a number of ST7 software tools. These tools run under the Windows® 95, 98, 2000, Millenium and Windows® NT® operating systems.

Note: To install the software on “MCU on CD”, Windows® 2000 and NT® users must have administrator privileges.

To install and setup the ST7 software tools, follow these steps:

- 1 Close all other open applications on your Windows desktop.
- 2 Insert the “MCU on CD” into your CD-ROM drive. The CD-ROM’s autorun feature will open up a welcome screen on your PC. If the autorun feature does not work, use Windows® Explorer to browse to the CD-ROM’s root folder, and double-click on `Welcome.exe`.
- 3 Select **Install Your Development Tools** from the list of options. A new screen will appear listing the different families of STMicroelectronics MCUs.
- 4 Use your mouse to place the cursor over the **ST7 Tools** option. Choose **ST Tools**, then **ST7 Toolchain** from the lists that appear.

- 5 The install wizard will be launched. Follow the instructions that appear on the screen.

You can choose to install the complete toolchain (i.e. the appropriate version of STVD7, STVP7 and the Assembler-Linker) for each type of development tool (development kit, HDS2 or EMU3 emulators or simulator), or perform a customized installation.

If you choose a customized installation, you can choose to install any or all of the STVD7 versions, and/or the Windows Epromer/STVP7 and/or the Assembler-Linker. **As a minimum, in order to emulate your application with your emulator, you must install STVD7 for HDS2.**

If you also install the ST7 Assembly Toolchain, you will be able to use the ST7 Assembly Toolchain as part of STVD7's integrated development environment.

The installation is now complete. You will be prompted to reboot your computer. You should do so before launching STVD7.

3.2 Launching STVD7

- 1 From your Windows desktop, select **Start>Programs>ST7 Tool Chain>Development Tools>STVD7 HDS2 emulator.**
- 2 The first time you open a version of STVD7 you will be prompted to enter the toolchain paths to be used by STVD7's integrated development environment.

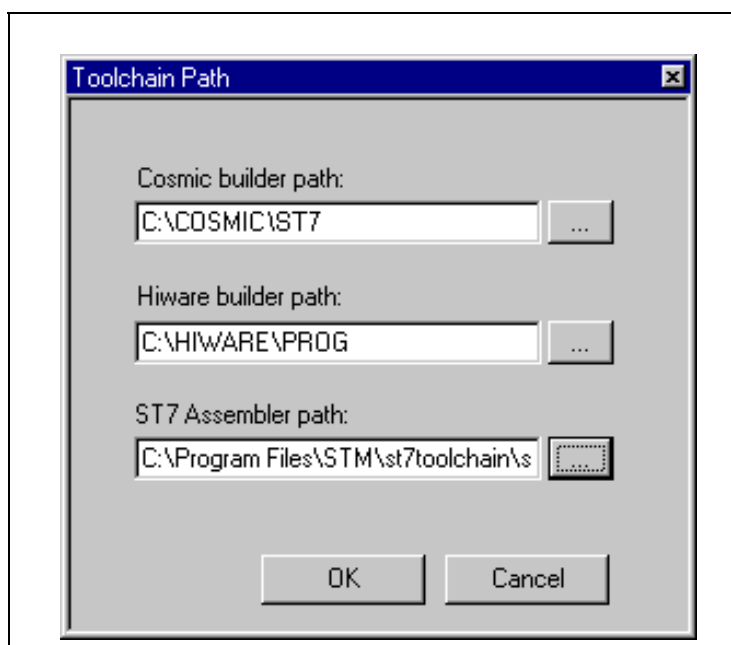

Figure 9: Toolchain Path dialog box

Enter the paths for the toolchains that you use (i.e. any or all of the Hiware, Cosmic or ST7 ASM toolchains) and click **OK**. (The default paths for each toolchain are shown below.)

- 3 If you choose **Cancel**, you will be prompted again to enter the toolchain paths the next time you launch STVD7.

Note: You may modify the toolchain path at any time from within STVD7—simply select **Project>Toolchain Paths** from the main menu to access the dialog box above.

3.3 About STVD7 debugging features

A number of advanced features are included in the STVD7 software:

- **Data Breakpoints** on the occurrence of a memory access via a read operation or a write operation, or both.
- **Instruction Breakpoints** on the occurrence of an opcode fetch.
- A **Logical Analyser** that allows you to control either the recording of the trace buffer, or a break in the execution of the application using a series of specific conditions (events).
- A **Trace window** to view the contents of the **trace buffer**, which permanently records in real time on 32-bits:
 - Address and data bus information.
 - Flag status and 4 external signal values.

You can record up to 1024 executed cycles. Using trace filtering, you can filter out only those cycles you wish to record in the trace buffer. You can equally control which of the recorded cycles are displayed in the Trace window using line filtering. Addresses, data, control/status bits and 4 user signals are displayed using mnemonic and user symbols.

- Internal synchronization signals can be output to either of two **Trigger Outlets** on the front panel of the emulator (OUT1 or OUT2). This feature enables you to count events using an external equipment, when optimizing software for example, or to synchronize an oscilloscope when debugging hardware.
- **Hardware Events** can be used to control the sending of signals to the trigger outputs.
- You can choose the output that you wish the signal to be sent to (i.e. either OUT1 or OUT2).
- A **Hardware Test** function that allows you to perform a number of hardware tests on the Development Board, at your choosing. Refer to *Running the*

Hardware Test for more information.

- A powerful **online help** facility can be invoked at any time to give additional information about the commands, the processor or the emulator kit.

3.4 Workspaces

STVD7 organizes project development and debugging into workspaces. Workspaces allow you to store application and project settings and save them, so that each time you wish to work on the project, you will find all of the settings exactly as you left them.

Creating a workspace is the first thing that you need to do when using STVD7 for the first time or when starting any new project. You must have an open workspace to work with STVD7. How to create a new workspace is described in detail in [Section 3.6](#). Sample workspaces for each supported toolchain are provided so that you can familiarize yourself with STVD7 (for a listing of sample workspaces, see [Table 1](#)).

Each workspace is comprised of three information sets: the project settings, the visual environment and debugging information.

- The **project settings** consists of the information necessary for a successful build of an application (commands to run, makefile file etc....). Your workspace's project settings include the definition of your application toolchain (see [Section 3.5](#)).
- The **debugging information** includes information on breakpoints, memory mapping, advanced breakpoints programs, trace etc..
- The **visual environment** consists of the open windows elements, along with their current layout, customized toolbars and menus. The visual environment is composed of two environments, one in the **Build context** and one in the **Debug context** (see [Section 3.12](#)).

The above workspace information is stored in three types of files: a workspace file (*.wsp) and two auxiliary files (*.wed and *.wdb).

Both project settings and debugging information is stored in the same workspace file (*.wsp). In addition, to allow you to use the same workspace file for any STVD7 version (such as the STVD7 Simulator version, STVD7 for HDS2 Emulator, STVD7 for DVP, and/or STVD7 for EMU3 Emulator), the project settings and debug information (such as the toolchain used, MCU emulated, memory mapping, etc.) are kept separately in the same *.wsp file for each STVD7 version. This allows you to use the same workspace file to debug the same application for two different MCUs or MCU configurations on different STVD7 versions.

Visual environment information (such as the location of debug windows, the appearance of toolbars, and other aspects of STVD7's graphical interface) is saved in separate files for each of the two contexts of STVD7. Graphical interface preferences while in Build context are saved in a *.wed file, and graphical interface preferences while in Debug context are saved in a *.wdb file. Each of these files is attached to a given workspace.

Note that if you move a workspace file (for example, mywork.wsp) to a new folder, take care to move the associated *.wed and *.wdb files (mywork.wed and mywork.wdb) with the workspace file in order to preserve the latest visual environment of your STVD7 session.

3.5 Toolchains and application files

A quick summary of development toolchains and application file types supported by STVD7 will help you in setting up your workspace.

Three different development toolchains are currently supported by the STVD7. Each type of toolchain has its own application and executable file types, project environment and building tools (i.e. linkers and convertors):

- The **ST7 macroassembler toolchain** from STMicroelectronics, which generates either .s19 or .hex executable files with various intermediate files, such as .map or .lst files.
- The **Hiware C or Assembler toolchain**, which generates .abs executable files with various intermediate files, such as .o or .dbg files.
- The **Cosmic C or Assembler toolchain** which generates .elf executable files with various intermediate files, such as .o or .st7 files.

When you set up a workspace, you will need to define the following project settings:

- **The toolchain to be used**—Hiware, Cosmic or ST7 macroassembler.
- **The executable file** (*.abs, *.elf, *.s19 or *.hex depending on toolchain—refer to [Table 2](#)).
- **The maker program** for the toolchain. The maker program can be a part of the toolchain software (such as Hiware's maker.exe) or you can choose to use a generic maker such as Nmake.exe or Gmake.exe (which is provided with the STVD7).
- **The maker batch file** (*.mak or *.bat). This is a file which you create for each application which spawns the compilation and/or link step each time you wish to build or rebuild. In it, you define the conditions for recompiling, re-

linking or both.

Default *.mak or *.bat files are often included with the toolchains—for example, maker.mak is included with the Hiware toolchain and simply recompiles your application if it detects that the file has been saved since the start of your debugging session. The STVD7 software includes sample *.mak and/or *.bat files for each toolchain—these are listed in [Table 1](#).

Table 1: Sample files included with STVD7

Toolchain	Sample Workspace (with default path)	Sample Make and/or Batch files (with default path ¹)	Description of Make/Batch File
ST Macro assembler	.../realtim/realtim.wsp	.../realtim/tim_rtc.bat	Batch file that forces a recompile of the application.
	.../spim11/spim11.wsp	.../spim11/spim11.bat	Batch file that forces a recompile of the application.
Cosmic	.../c/cosmic/sample.wsp	.../c/cosmic/sample.mak	Recompiles only if one (or more) of the application files has been resaved.
		.../c/cosmic/sample.bat	Batch file that forces a recompile of the application.
Hiware	.../c/hiware/sample.wsp	.../c/hiware/build.mak	Recompiles only if one (or more) of the application files has been resaved.
		.../c/hiware/rebuild.mak	Forces a recompile of the application.

1) The full default path is: C:/Program Files/Stm/st7toolchain/stvd7/hds/sample/...

3.5.1 About executable files

The user should verify that the options to include debug information were active during creation of the project files. [Table 2](#) summarizes the way each toolchain functions and lists the different file types (source files, intermediate files and executable files) used and produced by the toolchain. The **executable file types**

and **intermediate file types** necessary to exploit fully the STVD7 capabilities are listed.

Table 2: Toolchain steps and their output files

Toolchain:	ST Macroassembler	Hiware	Cosmic
Compile or Assemble Step:			
Source File Types	.asm	.c, .asm	.c, .s
Required Options	asm -li macrost7.asm	<NONE>	+debug
Resulting File Types	.obj, .lst	.o, .dbg	.o
Linker Step:			
Required Options	lyn macrost7.obj, macrost7 asm macrost7.asm -sym -fi=macrost7.map	<NONE>	<NONE>
Resulting File Types	.map, .lst	.abs	.st7
Converter Step:	obsend macrost7, f, macrost7.s19, srec or obsend macrost7, f, macrost7.hex, intel	not applicable	cvdwarf
Resulting executable file:	.s19 or .hex	.abs, .elf	.elf
Necessary Intermediate Files:	.map, .lst	.o, .dbg	<NONE>

The **executable file(s)**, **source files** and any necessary **intermediate files** (these are listed above and contain debug information necessary to the STVD) should be located in the same project directory. You do this when you define your workspace.

*Note: It is always preferable to have access to all of the files generated by the development toolchain. However, you can load *.s19 or *.hex binary files directly and have limited debugging capabilities (refer to [Section 3.8](#)).*

3.6 Creating a workspace

- 1 Select **File>New Workspace**. This command opens the New Workspace window where you define the name of your workspace and the directory in which you want to work.

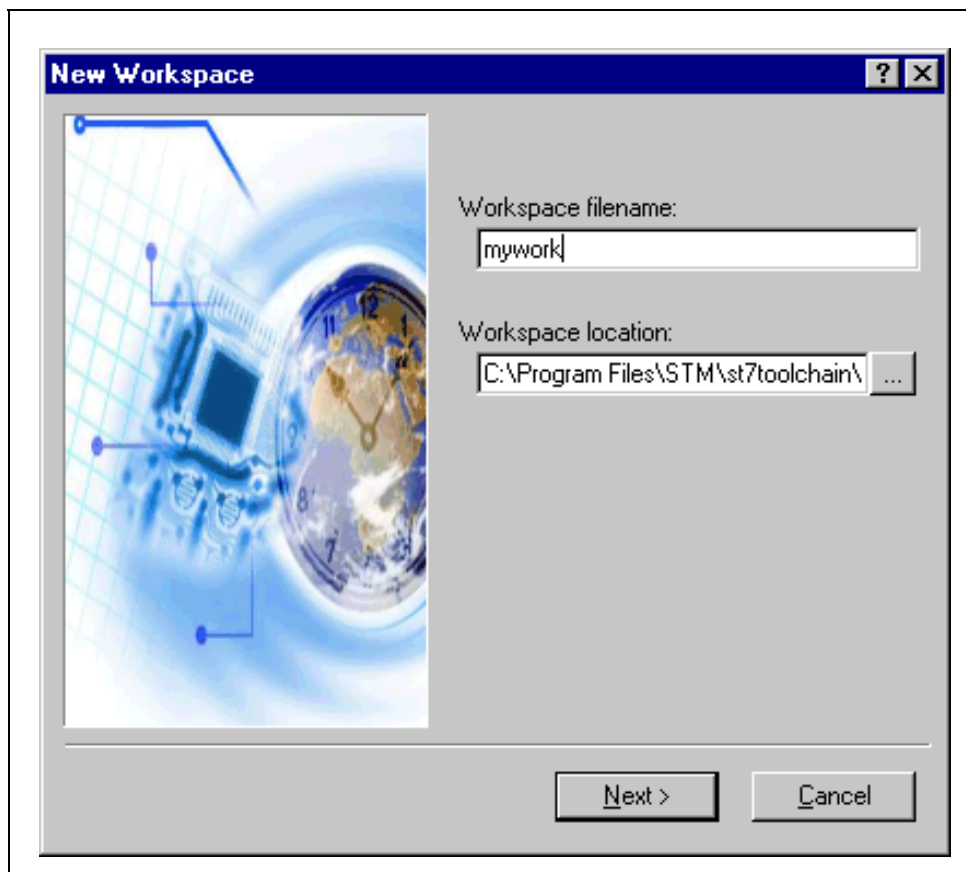

Figure 10: New Workspace window

- Then, click **Next>**. The **New Workspace: Project Settings** dialog box appears:

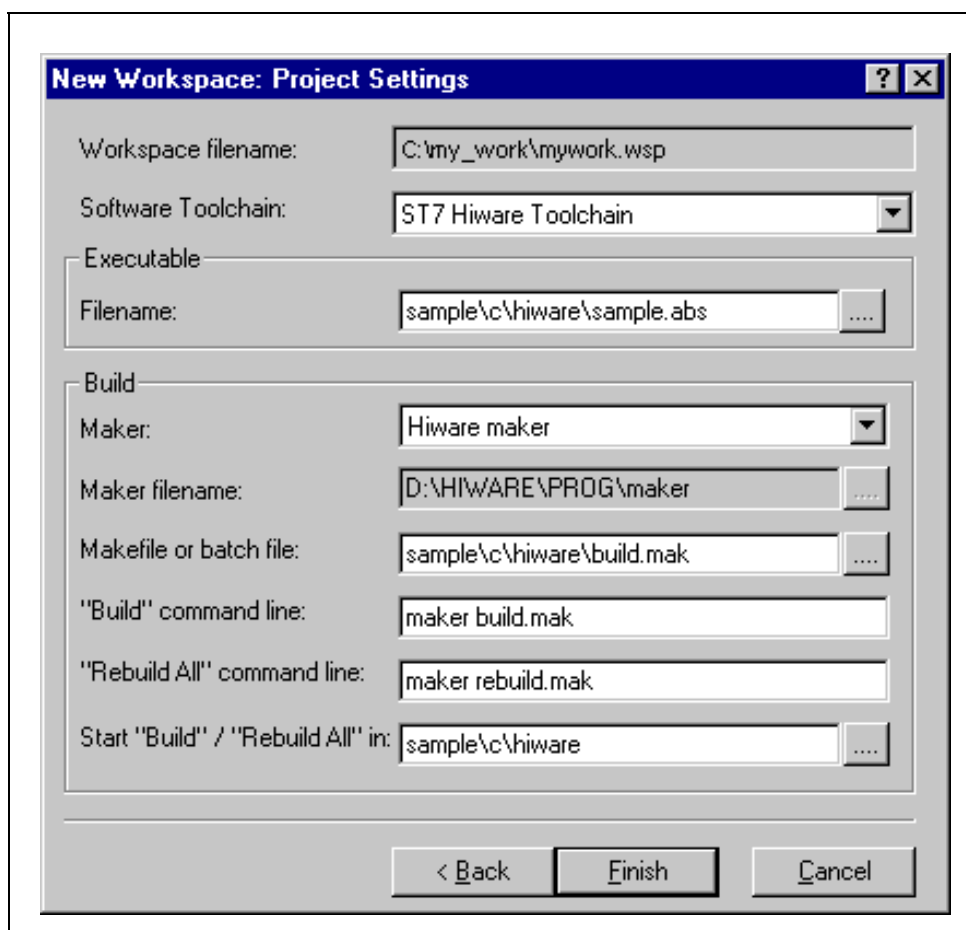



Figure 11: New workspace project settings

Here you enter your software toolchain, your executable filename and your build parameters either by typing or using the drop boxes.

- Select the toolchain and enter the name of your application's executable file. For example, if you wish to use the Hiware toolchain for ST7, your executable file will be of type *.abs (refer to [Table 2](#))—click on the browse button  to browse to the folder where your executable file is saved and select it.
- Next, choose the type of maker your application uses from the drop down list. In the example above, we have chosen the default Hiware maker, maker.exe. STVD7 will automatically look for this maker file in the folder you defined as the Hiware toolchain path.

- 5 Finally, you must define a make file or a batch file. There are several sample files provided with STVD7 (see [Table 1](#)). Here we have chosen `build.mak` as the default make file, used when the **Build** command is issued, and `rebuild.mak` as the make file to use when the **Rebuild** command is issued.
- 6 After you have finished defining your project settings, click **Finish**.

Once the workspace is opened, the Workspace window displays its contents.

When you create a new workspace, the first time you switch to Debug context (see [Section 3.12](#) for an explanation of STVD7 contexts), the MCU Configuration window will automatically open to prompt you to choose you target MCU and confirm or modify its option and memory configuration (see [Section 3.13](#)).

3.7 Opening an existing workspace

If you have already created a workspace, you simply need to open it in order to load all of your project settings into the STVD7.

Note: There are a number of sample workspaces provided with STVD7 that you can open to get familiar with STVD7. These samples are listed in [Table 1](#).

- 1 From the main menu, select **File>Open Workspace**.
 This command opens a window where you can browse to any folder you wish, and select an existing workspace.

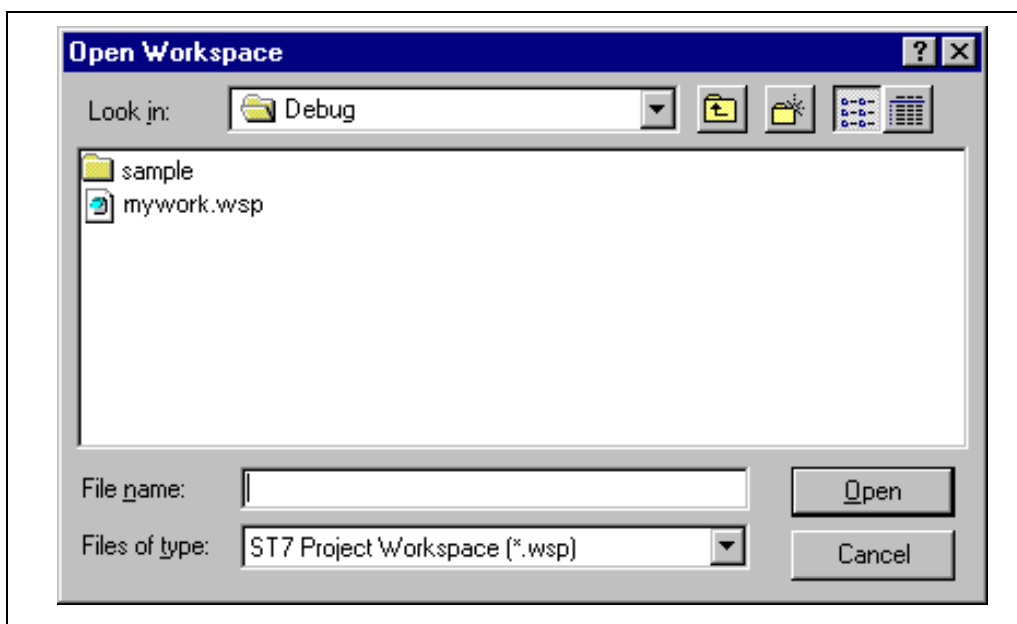

Figure 12: Open Workspace window

2 The Workspace window opens.

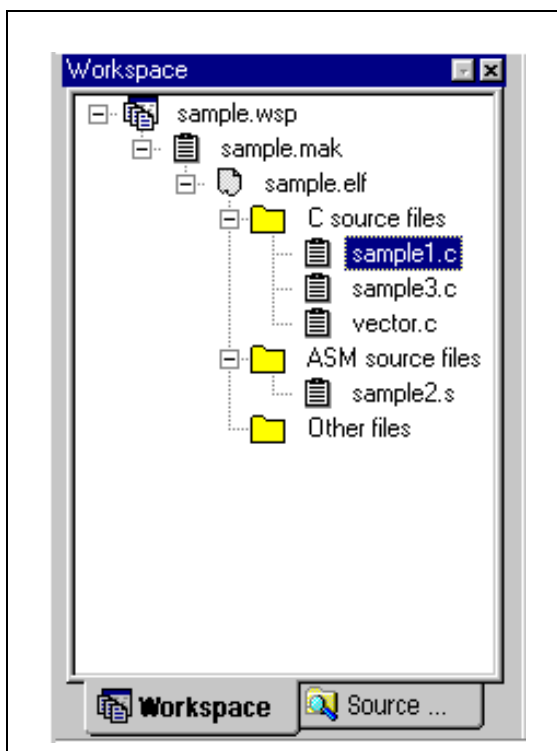

Figure 13: Workspace window

When a workspace is opened, all of the predefined project settings are loaded into the STVD7. The **Workspace** window will show a structured representation of the project. For example, mywork.wsp shows that it uses build.mak as the make file and sample.abs as the executable file.

Note: Although the name of the executable file is shown in the Workspace window, it has not yet been loaded into the emulation memory.

If you click on the **Source Directory** tab, the window will show every source and intermediate file type (*.c, *.s, *.asm, *.h or *.o) in the selected directory.

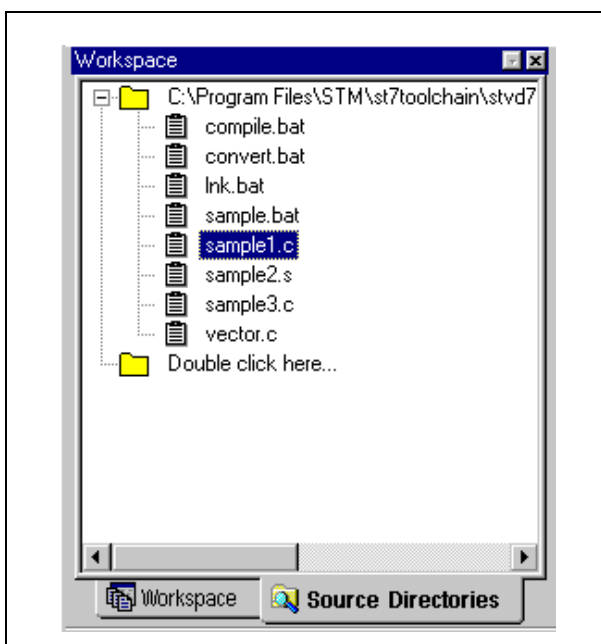

Figure 14: Source Directories tab

- 3 If there are no source files shown in the Source Directory tab of the Workspace window, or you wish to list additional files stored in another folder, you may browse to them by clicking the **Double Click here...** folder. The **Add Source Directory** window pops up allowing you to enter or browse for a new directory, and filter out the file types of interest. You may also choose to specify a

directory that is relative to the workspace directory by clicking on the **Path relative to the Workspace directory** option.

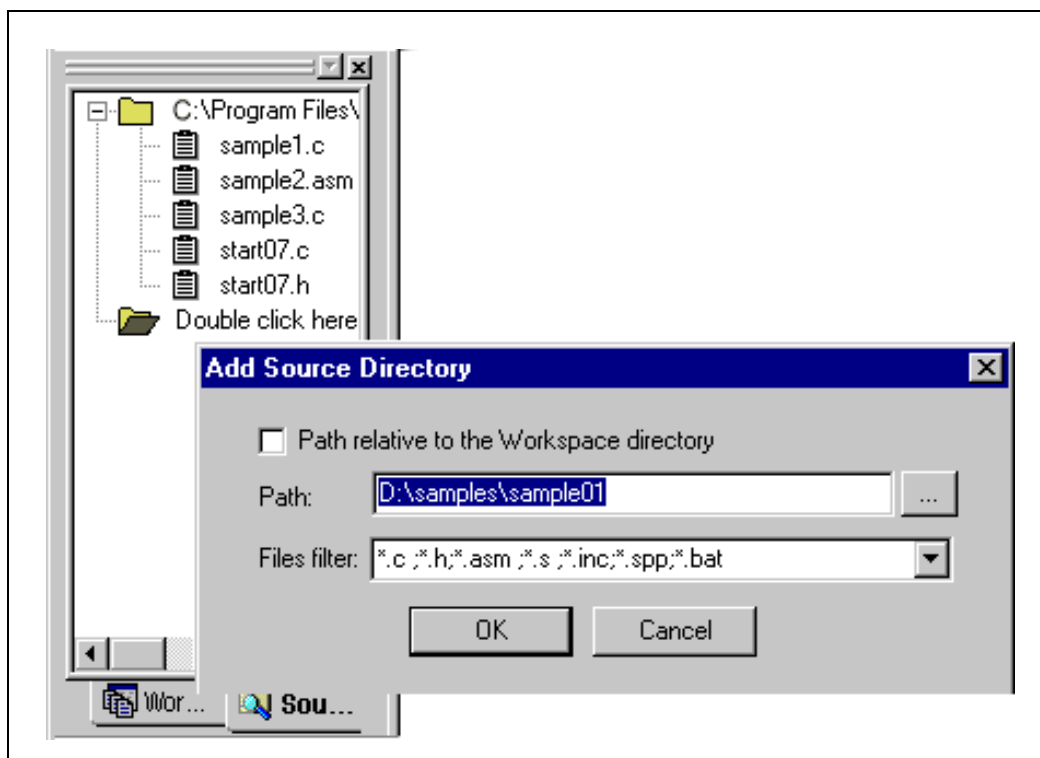



Figure 15: Add source directory

- To load the executable file, as well as any intermediate files, click the Debug icon  or the Reset Chip icon . The application and symbols will be loaded. Before you can start debugging, you must set the target hardware device by configuring the MCU.

3.8 Opening files directly for debugging (*.abs, *.s19, *.hex and *.elf)

You may also load `.abs`, `.elf`, `.s19` and `.hex` files for debugging directly using the **Open Workspace** command, without having to enter build parameters immediately. (You may always enter the build parameters at a later time by selecting **Project>Project Settings** from the main menu to open the Project Settings dialog box.)

Note: However, for `.s19` and `.hex` files to open correctly, the `*.map` and `*.lst` files generated by the ST7 toolchain during compilation must also be present. If this is not the case, refer to [Section 3.9](#).

The range of debugging features available will be more limited because the source files will not be accessible.

- 1 Launch STVD7 and select **File>Open Workspace** from the main menu.
- 2 Browse to the folder where your binary file is stored, and select **ST7 Application files (*.abs, *.s19, *.hex, *.elf)** in the *Files of type* field.

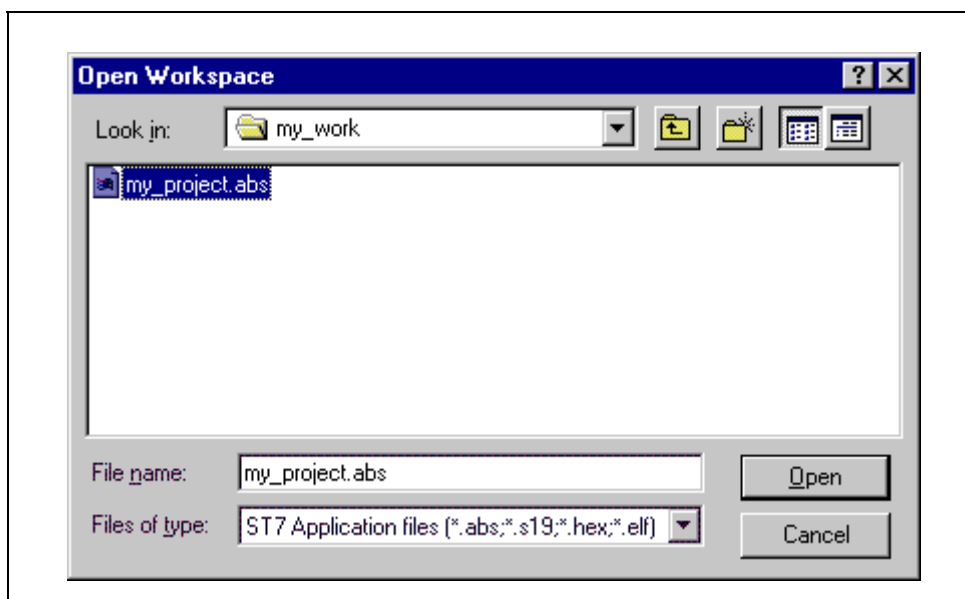



Figure 16: Open Workspace window

- 3 Select your binary file (*.abs, *.s19, *.hex or *.elf) and click **Open**.

3.9 Opening lone programmable files (*.s19 or *.hex)

If you do not have access to the *.map and *.lst files generated by the ST7 toolchain, you may also load isolated *.s19 and *.hex files from within STVD7.

The range of debugging features available when you open these files will be very restricted. You will only have access to the **Disassembly Window** and the **Memory window**.

- 1 Launch STVD7 and select **Debug>Start Debugging** from the main menu or click on .
- 2 Open the Memory window by selecting **View>Start Debugging** from the main menu.
- 3 With the cursor in the Memory window, right-click the mouse to open the Memory contextual menu.

- 4 In the Memory contextual menu, select **File>Restore Layout**. The Load File to Memory window opens.
- 5 Browse to the folder where your programmable file is stored, and select either the **Motorola format (*.s19)** or the **Intel format (*.hex)** in the Files of type field.

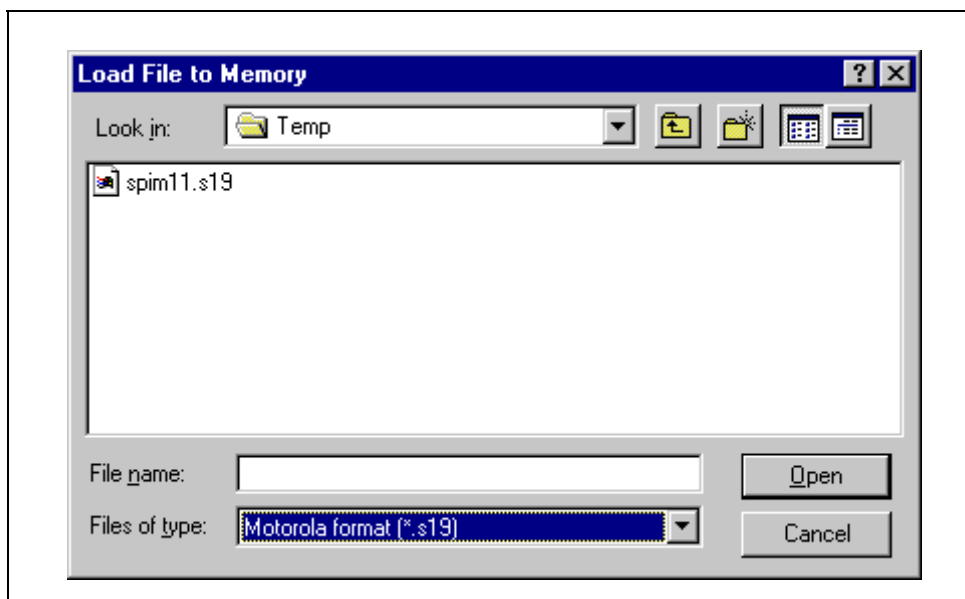

Figure 17: Load File to Memory

- 6 Select your programmable file (*.hex or *.s19) and click **Open**.

The binary code in the .s19 or .hex file will be loaded into STVD7 and you will be able to access the Disassembly window and the Memory window. A workspace file (of the same name as the programmable file, but with an extension .wsp) will be created automatically.

3.10 Changing your project settings

The Project menu contains the **Build** and **Rebuild All** commands you need to recompile your application after having made changes to it in the course of

debugging. You may also access your project or toolchain settings in the event you wish to change them.

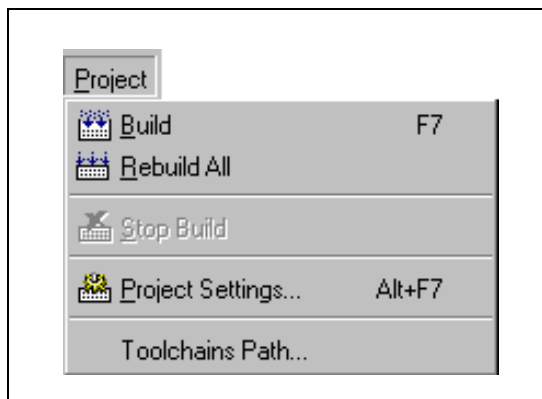

Figure 18: Project menu

From the main menu, select **Project>Project Settings**.

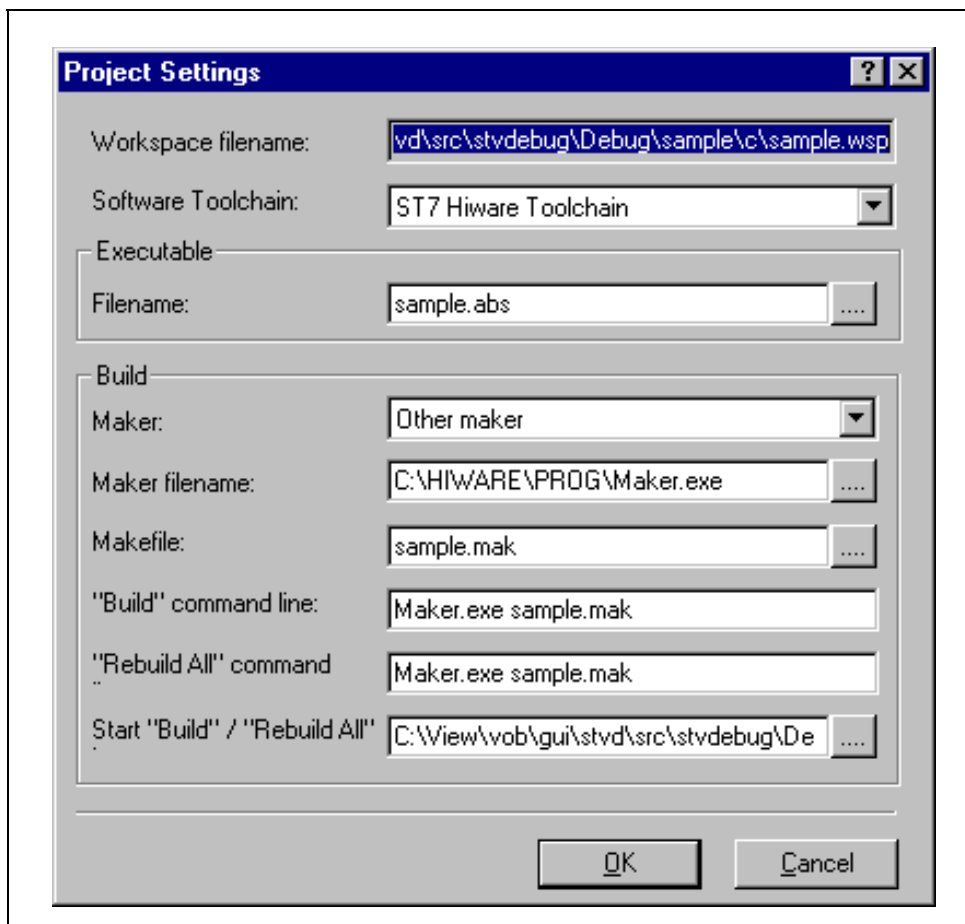

Figure 19: Project Settings window

You can change your settings here and continue running your application. When you exit STVD7, the system will ask you if you want to save these settings in the workspace you have been working in. If you choose **yes**, these will become your new workspace settings; if you choose **no**, these settings will be lost.

The **Toolchain Path...** item invokes the following window:

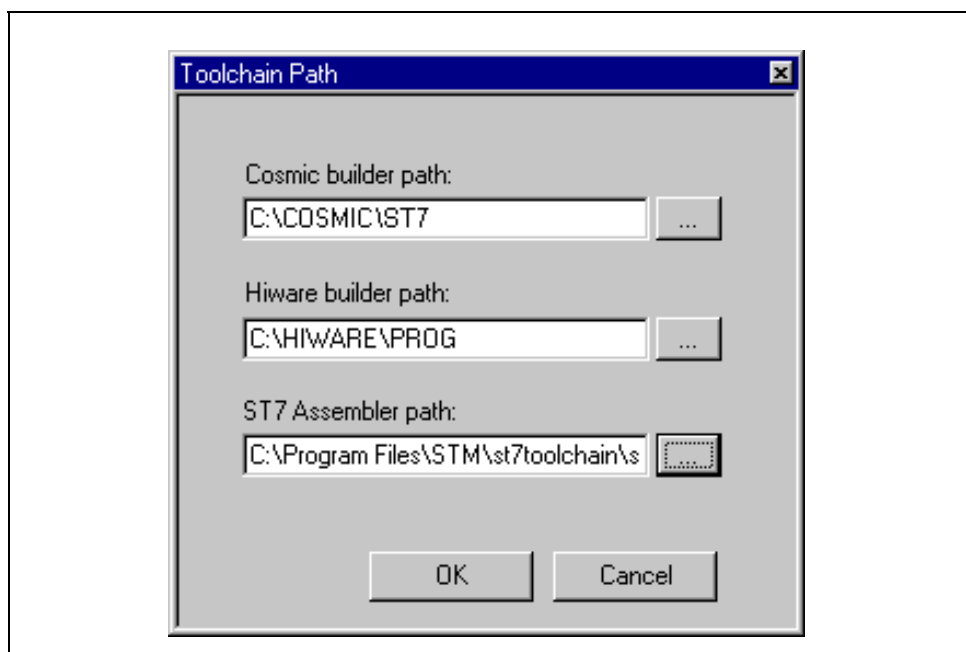



Figure 20: Toolchain paths

In this window, you can define your builder and/or Assembler paths. Clicking  opens a browser window.

3.11 Saving workspaces

Whenever the current workspace is closed, it is automatically saved. This can happen either when exiting STVD or opening or creating a new workspace.

In addition to this, a workspace can be explicitly saved with the **File>Save Workspace...** or **File>Save Workspace as...** commands.

The user is given the choice of which of the workspace elements to include in the saved file. Either the **visual environment** or the **debugging information** may be saved alone, or both may be saved together. This is configured as follows:

- 1 From the main menu, select **Tools>Options**.
- 2 In the Options window that opens (see [Figure 21](#)), select the **Workspace** tab.

- 3 Choose whether you wish your saved workspace to include either the visual environment or the debugging information or both.
- 4 Select which windows will appear docked when a project is opened by checking the appropriate check boxes in the *Floating windows in the main frame* area. Only windows currently docked in the main window can be included.

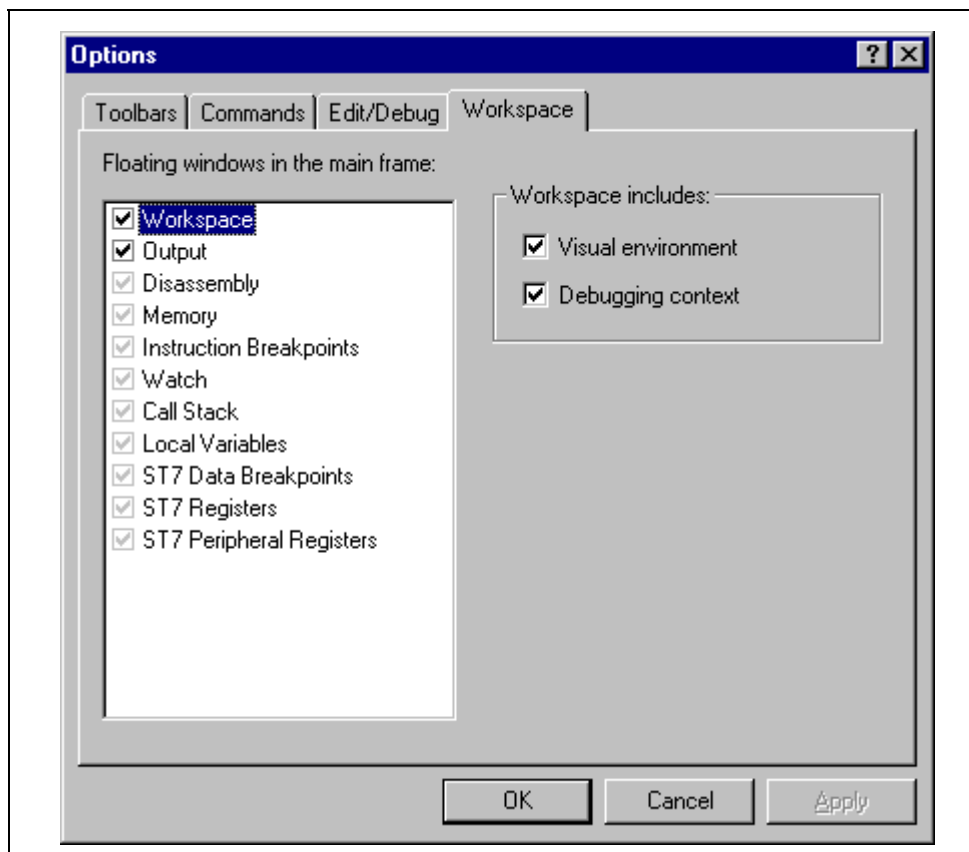

Figure 21: Workspace tab of Options window

- 5 Click **Apply** to confirm your settings.
- 6 Click **OK** close the dialog box.

In addition, open file contexts and current window positions are saved when the workspace is closed. This feature restores the workspace window, window layout and file views to that which was current when STVD7 was closed. The toolbar layout, plus customized toolbar content is also saved and restored with the workspace (options set via the tabs entitled **Toolbars** and **Commands**).

By default (i.e. when saved automatically) the workspace is saved as file *<application>.wsp*. The name of the file corresponds to the name used for the executable file (for example, *<application>.abs* for a Hiware executable file).

Note: Using the **Configuration Setup** dialog box (available from the MCU Configuration dialog box), you can also control what type of MCU configuration information is restored from a workspace file (*.wsp).

3.12 Debug context and Build context

There are two STVD7 contexts, the **build context** and the **debug context**. Until now, in creating a workspace, and defining your project settings, you have been in the build context. To proceed step—configuring your MCU—you need to change to the debug context.

Briefly, the two contexts are different in that:

- In the build context, you can open and close workspaces and build or re-build the application executable file.
- In the debug context you set the emulated MCU configuration (this step is described in [Section 3.13](#)) and debug the executable file created while in the build context.

3.12.1 Build Context

The build context is the context set when starting STVD7. In this context, it is not necessary to be connected to an emulator and the debug commands are not available. You can also edit the source files of an application and perform the use the **Build** command to perform compile and link actions in an interactive and iterative way to re-build the application executable file.

3.12.2 Debug Context

In this context, the following debug actions can be carried out:

- Loading, running and stopping the application.
- Defining the MCU configuration (MCU options and memory mapping).
- Viewing source and disassembled code.
- Setting instruction breakpoints with a counter and/or condition.
- Setting data breakpoints.
- Viewing local variables, memory and ST7 registers.
- Viewing history of execution from the trace buffer or with the Call Stack feature analyzing the performance of a piece of code.

3.12.3 Switching between contexts

The switch between contexts usually occurs when the **Start Debugging** and **Stop Debugging** commands are used.

From the main menu, choose **Debug>Start Debugging** or **Stop Debugging** or click on the **Start Debugging** or **Stop Debugging** icons shown in [Chapter 3](#).



Figure 22: Start Debugging and Stop Debugging icons

While debugging, the editor allows source files to be modified. To switch to the Build context perform either a **Build** or **Rebuild** action or use the **Stop Debugging**

3.13 Configuring the MCU

After you create or open a workspace, the next step you must perform before starting your STVD7 debugging session is to define and configure the target device (MCU) that you wish to emulate.

The target device is defined and configured from the MCU Configuration window.

- 1 First, ensure that you are in **Debug context** by clicking on . (STVD7 has two contexts: Debug context and Build context—these are described in [Section 3.12](#).)

Note: The first time you enter into the Debug context after having created a new workspace, the MCU Configuration window will be opened automatically.

- 2 Select **Tools>MCU Configuration** from the main menu. The MCU Configuration window will open.

An example of a typical MCU Configuration window is shown in [Chapter 3](#).

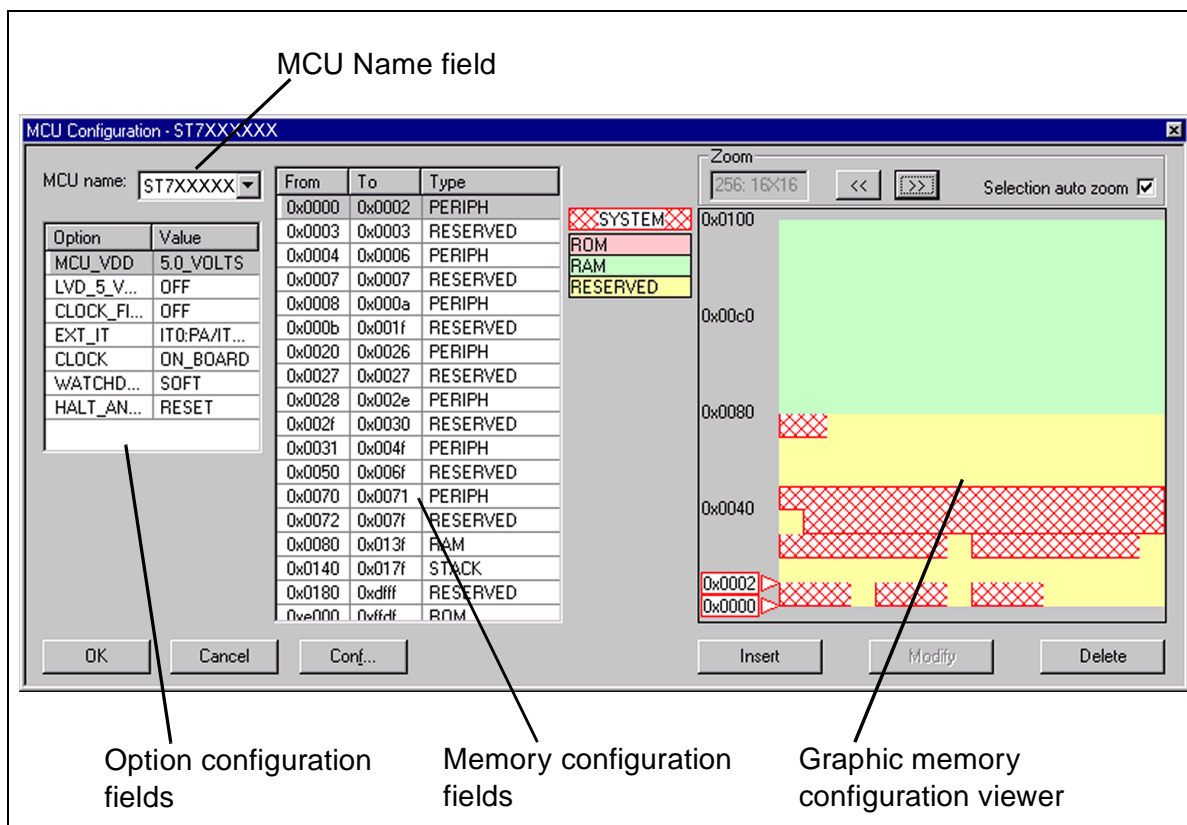

Figure 23: MCU Configuration window

Note: The options shown in the above example may not be available for your particular target MCU.

- 3 Set the Target MCU.** In the MCU name field, select the target device for which the application is intended from the dropdown box. Once a target MCU has been chosen, the *Option configuration* and the *Memory configuration* fields will show the default values for this device.
- 4 Configure the MCU Options and On-Chip Peripherals.** All of the configurable options on your target hardware device are listed in the *Option configuration* fields. Beside each *option*, a default *value* is given. You may change this value by clicking on it and choosing a new value from the drop down list. This allows you to configure your target device's options and on-chip peripherals. Depending on the MCU selected, the default settings in the *Option configuration* fields will change. It is up to you to configure those options that will impact your application so that the emulator accurately emulates your target device.

Note: For more information about the configurable options available on your target hardware device, please consult your target MCU's datasheet.

5 Configuring the MCU Memory. The default memory settings depend on the MCU selected. However, you can configure the memory settings as you wish if your application requires non-default settings. This feature would enable you, for instance, to temporarily increase the ROM size during the development phase of your application.

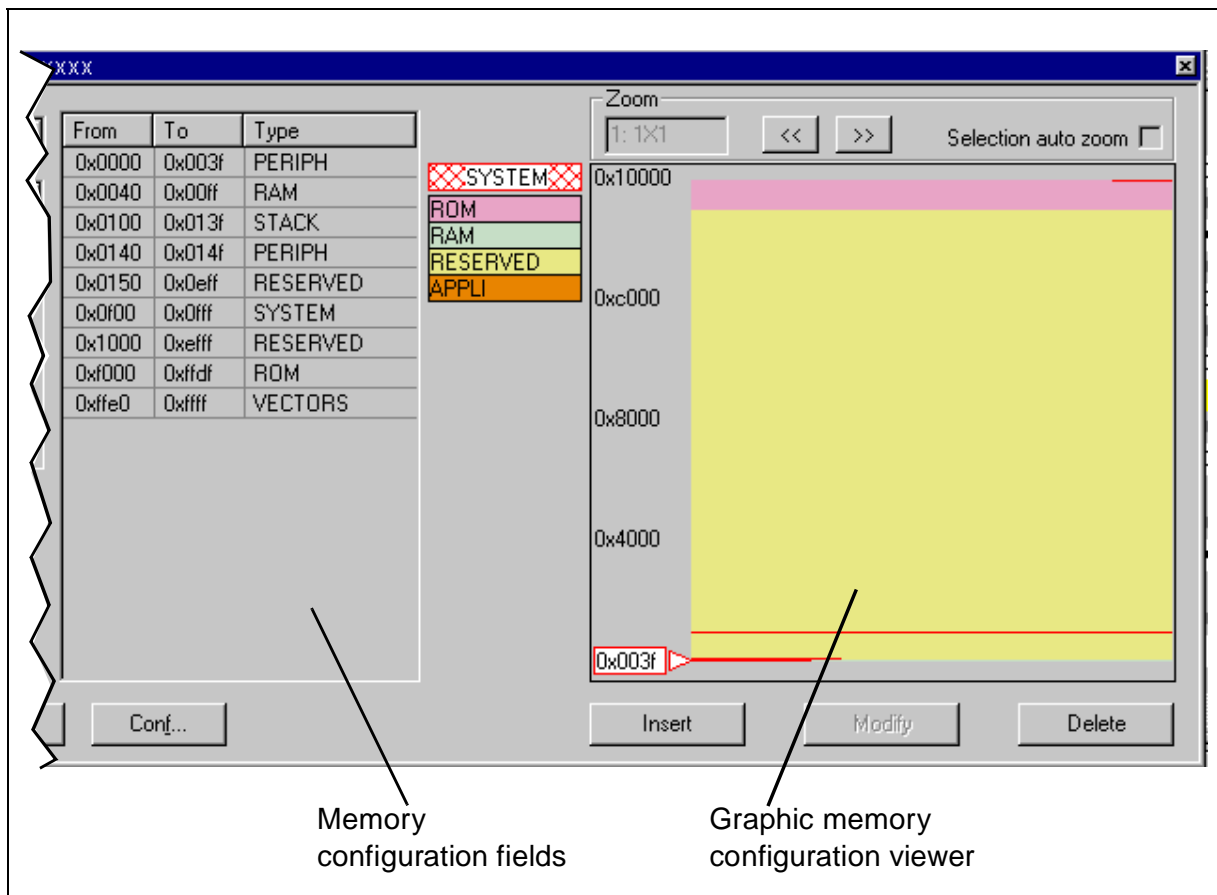

Figure 24: Memory mapping

There are two methods for configuring the memory settings on the MCU: by typing in the start and stop addresses of each memory zone into the **memory configuration window**, and by graphically moving the memory zone boundaries in the **graphic memory configuration viewer** (see [page 43](#) for more instruction).

Memory zone types

The left column of the **memory configuration window** indicates the address range of each memory zone. The right column indicates the memory type of each zone. Depending on your target MCU, the available memory types may be: Peripherals, RAM, ROM, Stack, System, EEPROM, Reserved, Vectors,

Application. Some of these zones can have their type and size modified, others cannot be modified. Their definitions and properties are explained as follows:

- **Peripherals:** Microcontroller internal or rebuilt peripherals registers. Their properties are defined as in the microcontroller datasheet. This memory cannot be modified.
- **RAM:** Random-Access-Memory of the microcontroller. This memory type can be modified.
- **ROM:** Read-Only Memory of the microcontroller. Write protected. This memory type can be modified.
- **Stack:** Stack of the microcontroller. This memory type cannot be modified.
- **System:** The emulator uses this space for emulation management. This memory type cannot be modified.
- **EEPROM:** This memory is internal to the microcontroller and is located inside the emulation device. The programming of this zone is done according to an automaton found in the datasheet. This memory type cannot be modified.
- **Reserved:** This memory zone is reserved as on the microcontroller. It is not allocated to any use and is write protected. This memory type cannot be modified.
- **Vectors:** This memory zone contains the user interrupt vectors zone. It is write protected. This memory type can be modified.
- **Application:** This memory type is microcontroller-specific. The user can add memory or peripheral resources on its hardware. It is not available on every emulator. Properties are linked to the user hardware. This memory type can be modified.

For most target MCUs, you may modify the following types of memory zone: **RAM**, **ROM**, **Reserved** and **Application**. This feature would enable you, for instance, to temporarily decrease the RAM zone, increase the size of the ROM (to exceed what is available on the real microcontroller) during the first stages of development. Once your program is functional, you can start to optimize its size by reducing your code and returning these zones to their original size. There are two different actions you may perform on the memory configuration:

- change the type of an entire existing zone.
- define a new zone of any type wherever possible.

To change an existing memory zone:

- 1 Select the memory zone to be modified.

- 2 Click on the **Modify** button at the bottom of the window. A **New MCU Memory Range** dialog box will open, allowing you to change either the address range and/or the memory type of the memory zone.

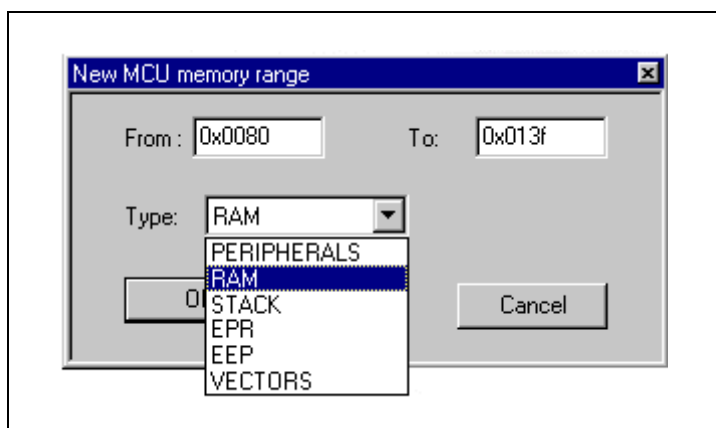

Figure 25: New MCU memory range

To create a new zone of any type:

- 1 Click on the **Insert** button. The **New MCU Memory Range** dialog box will appear.
- 2 Enter the address range of the new memory zone in the *From* and *To* fields.
- 3 Select the type of the new memory zone in the *Type* field.
- 4 Click **OK** to validate your choice.

The new memory zone will then appear in the **MCU Configuration** window **unless** you tried to create a new zone in a non-modifiable memory space (such as Stack or EEPROM).

To use the Graphic Memory Configuration viewer:

- 1 In the memory configuration window, click on the zone whose boundaries you wish to move.
- 2 Check the **Selection auto zoom** box in the upper right-hand corner. The graphical view of the memory configuration will be scaled so that the zone you have selected is easily visible.
- 3 At the upper and lower boundary of the zone, at the left-hand side of the graphical viewer, you will see a small triangle and rectangular box giving the boundary addresses of the memory zone. You can change a boundary address by dragging and dropping the triangle with the mouse to its new location. The triangle can be moved either up or down, left or right in the graphical viewer.

The MCU configuration that you specify will, by default, be saved in a workspace file (*.wsp) for the project. The next time the application is opened, the STVD will automatically set the MCU configuration (as well as the layout of opened windows and other debug information) to the same conditions you had when you left the last debugging session.

If you do not wish your MCU configuration information to be saved in the workspace file, you must alter the default Configuration Setup options by clicking on the **Conf...** button.

3.14 Start debugging!

Once in **debug context**, you are now ready to start debugging your application using the emulator. Full documentation on how to:

- control your STVD7 work environment
- use its integrated editor
- use the many debugging windows and features

is available from the online help and the online STVD7 user manual, located under **Help** in the main menu.

4 EMULATOR FEATURES

4.1 Main features of the ST7 HDS2 emulator series

The features described below are common to all ST7 HDS2 emulators:

- Real-time emulation capability (internal frequency from internal 0.5 MHz up to 8 MHz).
- Full memory emulation (up to 64 KB).
- Real-time trace with 3 event conditions allowing selective recording.
- Hardware breakpoint capability on instruction Fetch.
- Hardware breakpoint capability on address.
- Breakpoint capability on invalid address access.
- Breakpoint capability if trace is full.
- 1K x 32-bit real-time trace (address, data, ctrl).
- 6 different modes to configure trace access by combining 3 event conditions.
- Selective trace recording capability.
- 2-Trigger output capability.
- Can use as an external clock source either the on-probe oscillator, or an external source via the front panel input.
- 4 probe inputs to display application signals in the trace.

4.2 Specific features

The features described below are specific to the ST7MDTU5-Active Probe:

- 12 MHz internal clock operation.
- The application power supply follower allows this emulator to run with application V_{CC} from 2.4 V to 5.5 V. When the probe is not connected to an application board or if the application board isn't powered (application $V_{CC} < 2.4$ V), the V_{CC} default value is 2.4 V.
- All I/O pins of the ST7265 MCU and its sub-family are directly interconnected to the user application board. No buffers or protective devices are inserted on the probe.

4.3 Emulator architecture

The ST7MDTU5-EMU2B emulator is composed of 2 parts:

The **ST7 HDS2** (Hardware Development System) contains all of the common resources necessary to emulate any ST7 device (such as memory and the link interfaces with the PC). This board is connected to the PC via a parallel link and to the second part by two 50-pin connectors.

The **ST7MDTU5-Active Probe** contains the specific resources necessary to emulate the ST7265x family of MCUs, and is used as a link between the ST7 HDS2 and your application.

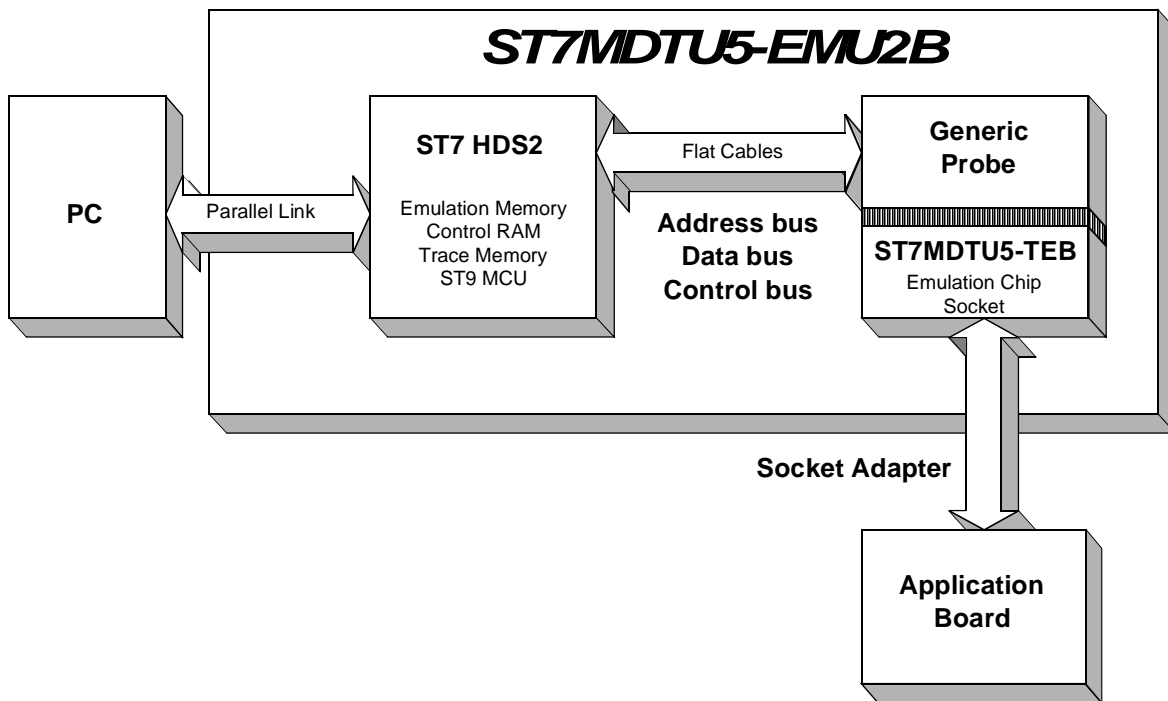

4.3.1 ST7 HDS2 hardware

The hardware functions provided by this component are listed below:

- **HDS2 CPU:** Used to control the ST7XXX-HDS board and manage common HDS2 features such as the parallel link with the PC.
- **RAM memory:**
 - 64K bytes for ROM and RAM emulation.
 - 64K bytes as break points control and Mapping.
 - 1K x 32-bit as trace memory.

- **Hardware breakpoint control logic** to manage breakpoints from the 16-bit address bus.
- **Logical analyser control logic** to manage sophisticated recording and break events in the trace.
- **PC link:** parallel interface for communication with PC.
- **ST7MDTU5-Active Probe interface**—3 buses connect the ST7 HDS2 to the **ST7MDTU5-Active Probe**:
 - Address bus (16-bit) of the ST7 emulation chip used for RAM addressing and trace.
 - DATA bus (8-bit) of the ST7 emulation chip.
 - Control bus to manage ST7MDTU5-Active Probe hardware-like breakpoint features.

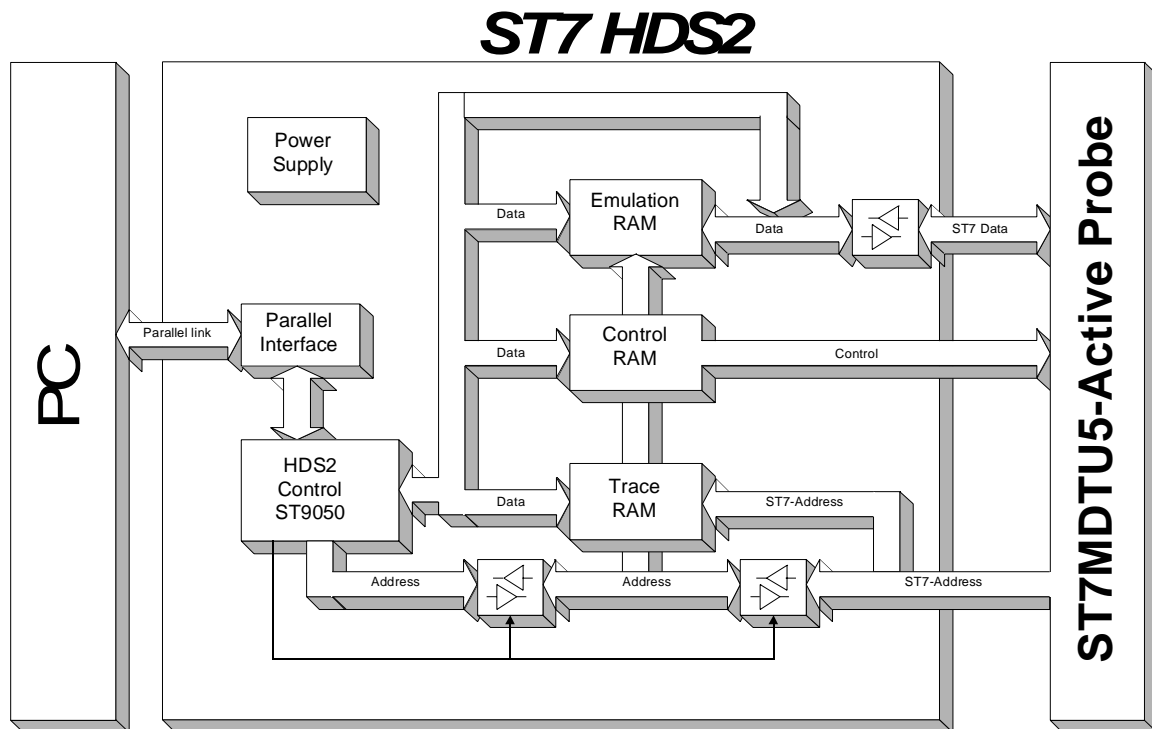

4.3.2 ST7MDTU5-Active Probe hardware

The ST7MDTU5-Active Probe is made up of two probe components—a ST7 Generic Probe and a ST7MDTU5 Target Emulation Board (TEB) included in the emulator kit. See [Step 3: Connecting the probe to your application board](#) on page 17 for more details.

4 - Emulator Features

ST7MDTU5-EMU2B User Manual

The hardware functions provided by the ST7MDTU5-Active Probe are:

- **Probe Emulation MCU:** This is an ST7 microcontroller similar to those of the emulated target device(s), which runs in emulation mode. It acts as the ST7 core and gives access to all on-chip peripherals.
- **Control logic:** Control logic is provided to manage the software execution by the user (i.e. program running and halting).
- **Application V_{CC} follower:** The probe emulation MCU is supplied with the same voltage as the application (i.e. must be in the range 2.4 V to 5.5 V).
- **ST7 HDS2 interface:** All of the communication buses connecting the active probe to the ST7 HDS2 board are buffered:
 - ST7 Address bus (16-bit) of the ST7265 in emulation mode.
 - Data bus (8-bit) of the ST7265 in emulation mode.
 - ST7 emulation chip control bus for trace recording, breakpoints and memory mapping.

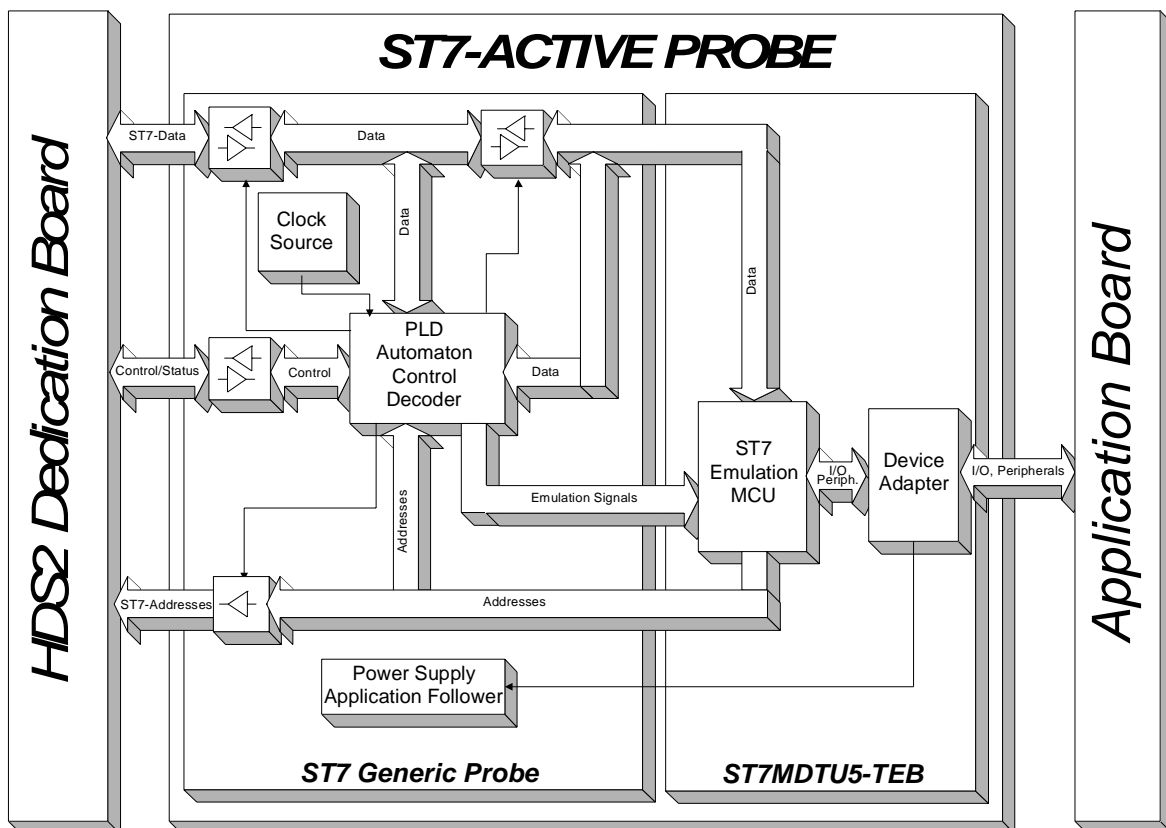

4.4 Output triggers

Your ST7 HDS2 emulator has two output triggers, OUT1 and OUT2. The OUT1 and OUT2 outlets are available via SUB-click connectors located on the front panel of the ST7 HDS2 emulator box.

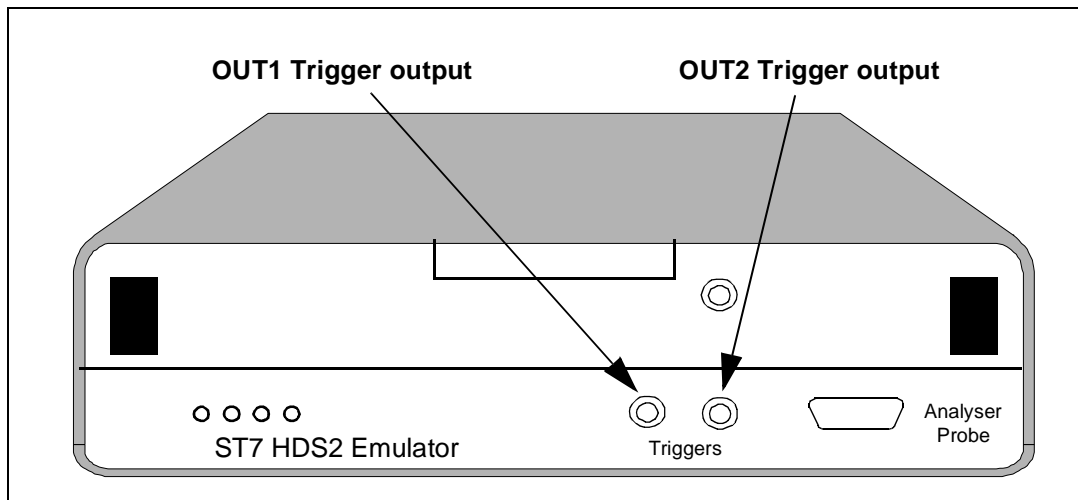
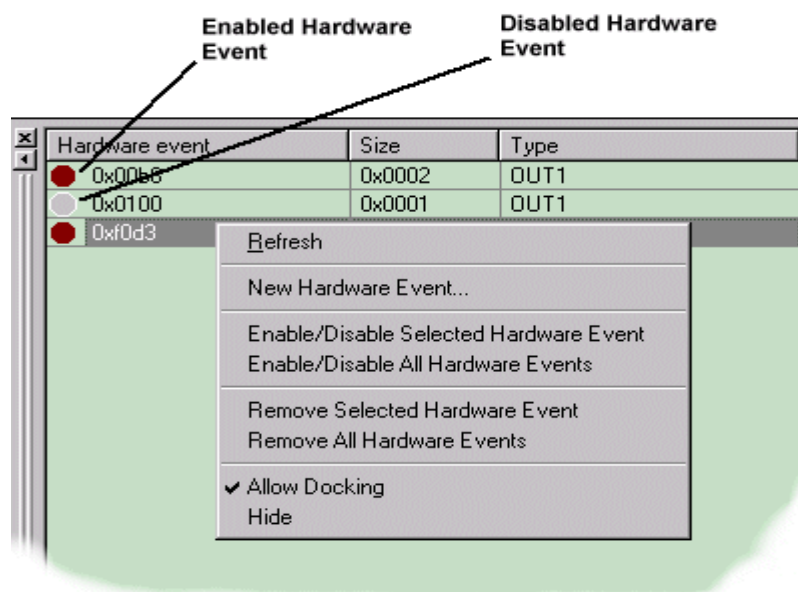

Figure 26: Trigger outputs

You can program the output signals to these triggers using ST7 Visual Debug:

- 1 From the main menu in ST7 Visual Debug, select **View>Hardware Events**. The Hardware Events window will open in your workspace.



- 2 Right-click the mouse while the mouse pointer is anywhere in the **Hardware Events** window.
- 3 Choose **New Hardware Event** from the contextual menu. The **Hardware event settings** dialog box will open as below.

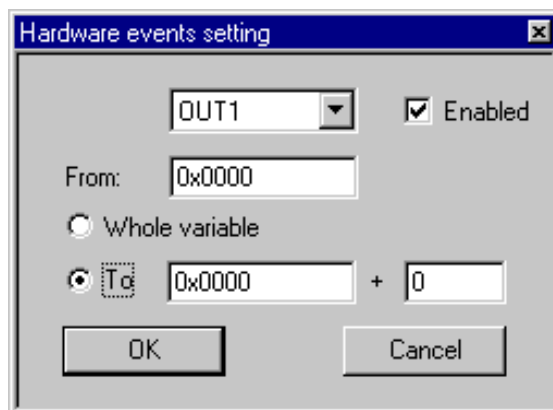

- 4 Choose the trigger output that you wish the signal to be sent to (i.e. OUT1 or OUT2) and check the **Enabled** box.
- 5 You may trigger output signals by setting an event on any of the following:
 - **a whole variable**—creating an *event for synchronization*, which enables you to preset the pulse synchronization for external equipment connected to the output trigger.
 - **a single address**—also creates an *event for synchronization* (see above).
 - **a range of addresses**—creating an *event to measure time*, which enables you to measure the time elapsed during a subroutine execution.

A positive impulse is emitted on OUT1 and OUT2 when a specific condition is met. This impulse lasts for one Clock cycle.

4.5 Analyser probe input signals

The ST7 HDS2 allows you to use 4 external input signals (TTL level). These signals are on pins 6,7,8,9 of the Analyser Probe connector located on the front panel of the emulator as shown below. You can view these probe inputs using ST7 Visual Debug. From the main menu, select **View>Trace**. The input signal values are listed under the Sig column (AL3..0).

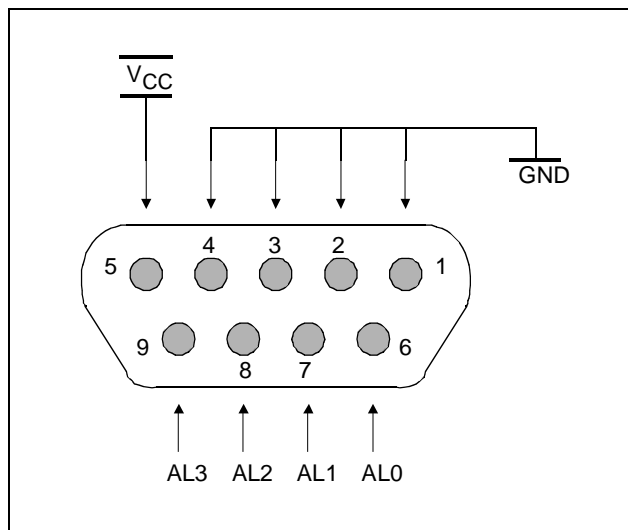

Figure 27: Analyser probe connector

ST7 Visual Debug's **Logical Analyser** allows you to use these input signals to define trace filtering or output trigger events. From the main menu, select **Tools>Logical Analyser** to open the dialog box. A full description of how to use this facility to control trace recording or trigger output signals is given in the ST7 Visual Debug online help.

A rainbow-colored cable will also be delivered to connect your application to these inlets. Each red connector is to be connected to your signal. Each black connector is to be connected to the reference ground for the signal.

Colors are attributed as follows:

- AL0 is to be taken between the RED (signal) and BROWN (ground) wires
- AL1 is to be taken between the YELLOW (signal) and ORANGE (ground) wires.
- AL2 is to be taken between the BLUE (signal) and GREEN (ground) wires.
- AL3 is to be taken between the GREY (signal) and PURPLE (ground) wires.

4.6 Front panel LEDs

Four LEDs on the front panel of the HDS2 box indicate the state of the development tool during emulation:

- **Power (Green)**—indicates that the 5 V power supply is ON.
- **Run (Yellow)**—indicates that the ST7 is running (not in RESET, WFI and HALT mode).
- **System (Red)**—not used with this emulator.
- **Reset (Red)**—not used with this emulator.

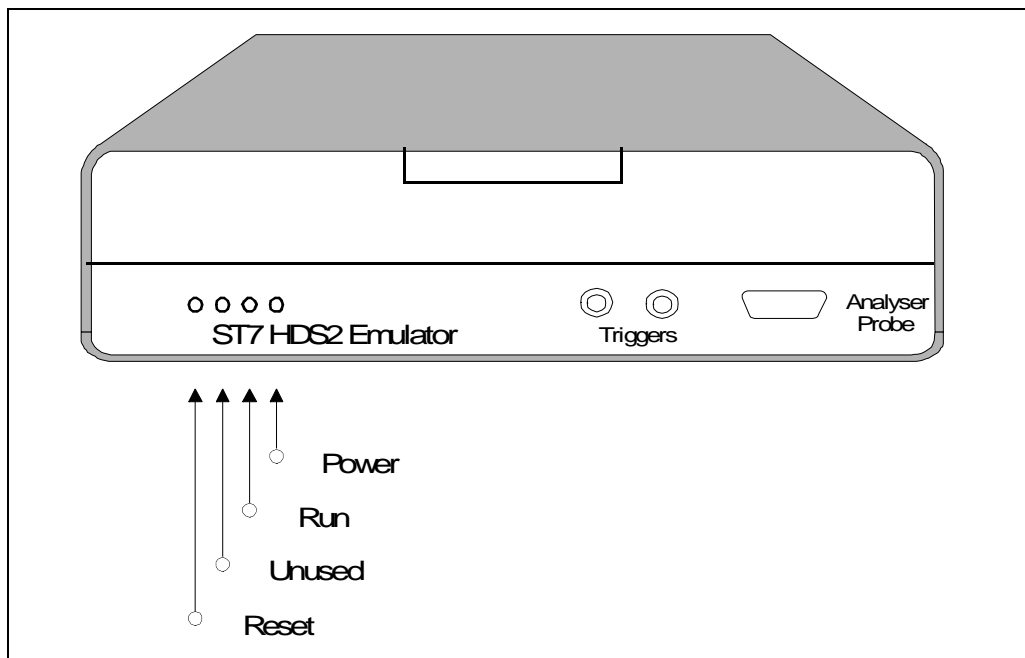

Figure 28: Front panel of HDS2 emulator

4.7 On-chip peripherals

You can configure certain on-chip peripherals in ST7 Visual Debug's **MCU Configuration** dialog box (refer to [Section 3.6: Creating a workspace](#) on page 28) so that the emulator accurately emulates your target device.

The on-chip peripheral options supported by the emulator are:

Fosc

The emulator supports only the **12 MHz** Fosc value that is generated by the emulator clock source.

4.8 Emulation functional limitations and discrepancies

Power supply

The application supply follower allows this emulator to run with an application V_{DD} ranging between **2.4 V to 5.5 V**. If the application isn't powered, or the $V_{DD} < 2.4 V$, the power supply is maintained at 2.4 V. If your application is powered by a voltage greater than 5.5 V, the emulator will limit this value internally to 5.5 V.

Low voltage detector management

The Low Voltage Detector is not yet available on this emulator release.

Option byte configuration

Some features of MDTU5 emulator are configurable under Option byte control. It is possible to modify those features with from the MCU Configuration window. The table below summarizes all of the configurations possible:

Name	Configuration	Description
WATCHDOG	Soft Hard	Watchdog activated by software Watchdog always active
PS_MODE	DUAL_MODE STAND_ALONE USB_MODE	Dual supply mode (normal) Stand-alone mode forced USB mode forced
PE5PU	PULL-UP ON PULL-UP OFF	Determines if a pull-up is connected on Port E5

Note: USBEN option bit is not configurable in emulation mode (USBEN alternate function is always enabled on Port F4).

APPENDIX A: EMC CONFORMITY AND SAFETY REQUIREMENTS

This emulator respects the EMC requirements of the European guideline 89/336/EEC under the following conditions:

- Any tester, equipment, or tool used at any production step or for any manipulation of semi-conductor devices must have its shield connected to ground.
- All ferrites provided with the emulator kit must be attached as described in the hardware installation instructions of the relevant user manual(s).
- Your emulator must be placed on a conductive table top, made of steel or clean aluminum, grounded through a ground cable.
All manipulation of finished goods must be made at such a grounded worktable.
- The worktable must be free of all non-antistatic plastic objects.
- It is recommended that you wear an antistatic wrist or ankle strap, connected to the antistatic floor covering or to the grounded equipment.
- If no antistatic wrist or ankle strap is worn, before each manipulation of the powered-on emulator, you must touch the surface of the grounded worktable.
- It is recommended that antistatic gloves or finger coats be worn.
- It is recommended that nylon clothing be avoided while performing any manipulation of parts.

APPENDIX B: TROUBLESHOOTING

B.1 Identifying the problem

IF THE FOLLOWING OCCURS:	THEN...
<p>Error Message (when starting the STVD7 for HDS Emulator): “No message received from emulator.”</p>	<p>Ensure that:</p> <ul style="list-style-type: none"> • The parallel cable is connected between the emulator and one of the PC’s parallel ports (LPT1 or LPT2). Note that the use of switch boxes between the parallel port connector of your PC and the emulator are not recommended. • The development board is powered on. • The parallel cable used is the one supplied with the kit by STMicroelectronics. <p>If none of the above items has been overlooked, this may mean that your parallel port connection needs to be reconfigured.</p> <p>Please refer to Section B.2: Changing the parallel port setup on your PC on page 59.</p>
<p>Error Messages (when starting the STVD7 for HDS Emulator): “Communication error with EMULATOR board.” or “SYSTEM ERROR DETECTED by EMULATOR BOARD: RESET CPU.”</p>	<p>Ensure that:</p> <ul style="list-style-type: none"> • The flat cables linking the ST77MDT00-Active Probe and the emulator box are properly connected. • The selected configuration file matches the connected ST77MDTU5-Active Probe configuration. If it doesn’t, from within ST7 Visual Debug, open the MCU Configuration dialog box by selecting Tools>MCU Configuration from the main menu. Choose the correct MCU target device in the dropdown list, then click OK to save your changes to the *.wsp file for your debugging session. Exit STVD7 and power off the emulator. Power on the emulator and restart STVD7 to ensure correct installation.

B.2 Changing the parallel port setup on your PC

Under certain circumstances, you may receive the following error message:

“Connection Error (LPT1/LPT2): Interconnection failure. Verify your input/output cable.”

This may mean that the setup of the LPT1 or LPT2 port on your PC is not compatible with the ST7MDTU5-EMU2B.

To set up the port correctly:

- 1 Shut down and restart your PC in order to enter the BIOS setup.
- 2 Follow the messages displayed on the screen and when prompted, press the key required to enter the BIOS setup (usually a function key or the ESC key).
- 3 Select the parallel ports menu. (This may be listed under I/O ports.)
- 4 Change the Mode of the LPT port that you have connected the development board to (i.e. either LPT1 or LPT2) to one of the following compatible modes, according to the following table:

Operating System	Compatible Parallel Port Modes
Windows 95 Windows 98 Windows NT4 Windows 2000	Bidirectional or Centronics (Nibble)

- 5 Save your changes and exit the BIOS setup.

B.3 Running the hardware test

The **Hardware Test** in ST7 Visual Debug lets you check that your emulator is correctly connected, configured and working. You can test components of the development board individually, or all at the same time.

If problems occur during debugging (such as bad debugger responses and unexpected behavior), you should check for hardware problems using the Hardware Test function, and if any are detected, contact your STMicroelectronics sales representative (see [Product Support](#) on page 65).

You may open the **Hardware Test** dialog box by:

- selecting, from the Main Menu, **Emulator>Hardware Test**
- clicking on the Hardware Test icon  in the **Emulator** toolbar.

Warning: Be cautious in performing a Hardware Test on the emulator while an application is open. The opened application WILL BE corrupted by the hardware testing process. If you find that your application has been corrupted, simply close the application, and reopen it.

The **Hardware Test** dialog box shows a list of different tests that can be performed on the emulator.

Check the box of each test that you wish to perform (they are all checked by default) and click **Apply** to start the hardware test.

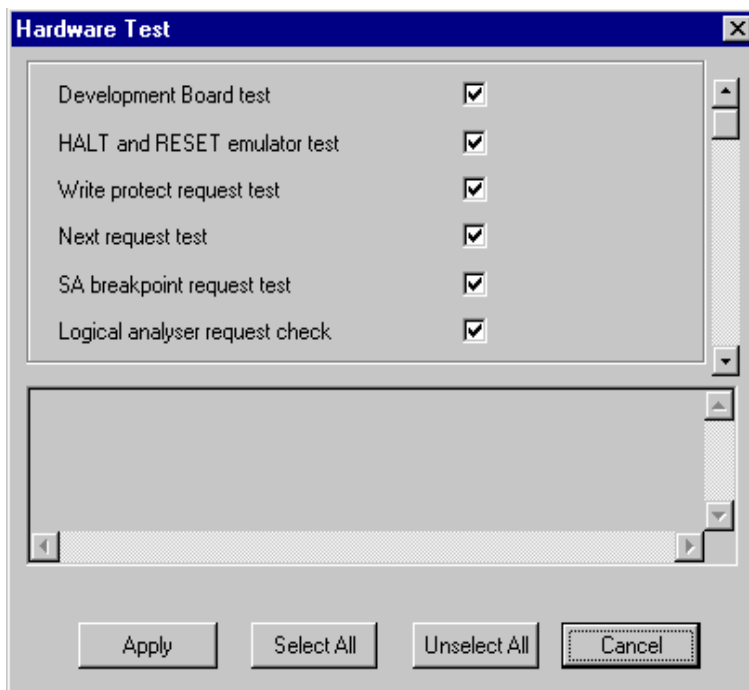

The Hardware tests will be performed one by one, and the results summarized in the dialog box as shown on the right:

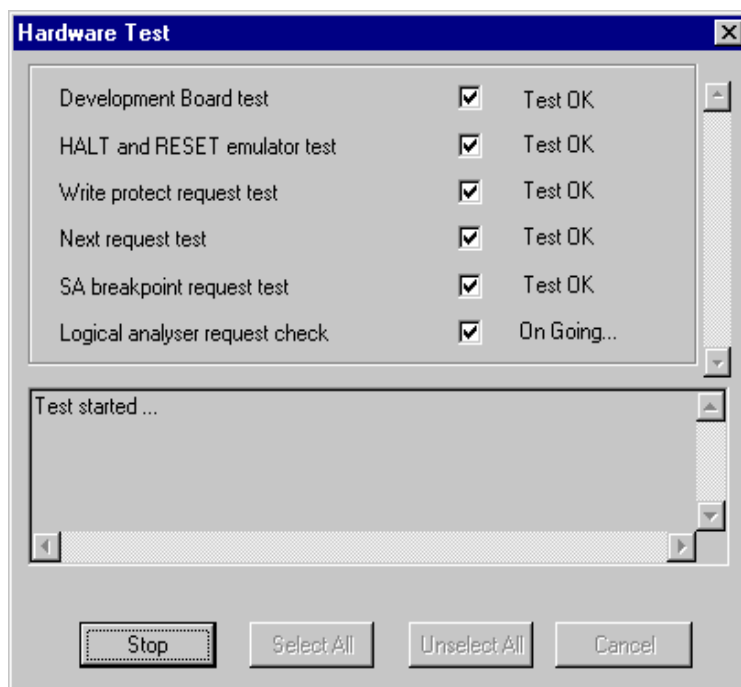

APPENDIX C: GLOSSARY

Application Board

This is the printed circuit board onto which you wish to connect the target ST7 MCU. It should include a socket or footprint so that you can connect the application board to your emulator or development kit using the probe and the appropriate device adapter. This allows you to emulate the behavior of the ST7 MCU in a real application in order to debug your application program.

Device Adapter

Device adapters are included in your emulator kit to allow you to connect the emulator to your application board. The type of device adapter depends on the target device's packaging. Many MCUs come in more than one different package, and you should therefore use the device adapter that corresponds to the type of package you have chosen for your application.

ECP

Extended capabilities port communication standard.

EPP

Enhanced parallel port communication standard.

MCU

Microcontroller Unit. Otherwise referred to as the "target device" throughout this manual. This is the core product (or family of products) for which the Development Kit is designed to act as an emulator and programming tool. In general terms, an MCU is a complete computer system, including a CPU, memory, a clock oscillator and I/O on a single integrated circuit.

ST7MDTU5-Active Probe

A printed card having connector pins that allow you to connect the Emulator to the MCU socket of the user application board. Using the active probe allows the HDS2 emulator to function as if it were the target device embedded in your application. The probe is connected to the emulator by two flat cables.

RC network

Resistor-capacitor network.

ST7 Visual Debug (STVD7)

A graphic debugger software package that allows you to debug applications destined for the ST7 family of MCUs, either using a built-in simulator function, a Development Kit or an HDS2 Emulator.

Target Device

This is the ST7 MCU that you wish to use in your application, and which your emulator or development kit will emulate for you.

TEB

Target Emulation Board. This is the interface between the emulator and the application board. It is directly plugged into the HDS2 Generic Probe and connected to the application board via an adapter.

User Application Board

Designates your application board.

PRODUCT SUPPORT

If you experience any problems with this product or if you need spare parts or repair, contact the distributor or ST sales office where you purchased the product.

Getting prepared before you call

Collect the following information about the product before contacting ST or your distributor:

- 1 Name of the company where you purchased the emulator kit.
- 2 Date of purchase.
- 3 Order Code: Refer to the side of your emulator kit box. The order code will depend on the region for which it was ordered (i.e. the UK, Continental Europe or the USA).
- 4 Serial Number: The serial number is located on the rear panel of the emulator box.
- 5 Target Device: The sales type of the microcontroller you are using in your development.

Contact list

*Note: For **American and Canadian customers** seeking technical support the US/Canada is split in 3 territories. According to your area, contact the following sales office and ask to be transferred to an 8-bit microcontroller Field Applications Engineer (FAE).*

Canada and East Coast

STMicroelectronics
Lexington Corporate Center
10 Maguire Road, Building 1, 3rd floor
Lexington, MA 02421
Phone: 781-402-2650

Mid West

STMicroelectronics
1300 East Woodfield Road, Suite 410
Schaumburg, IL 60173
Phone: 847-585-3000

West coast

STMicroelectronics, Inc.
28202 Cabot Road
Suite 650
Laguna Niguel, CA
Phone: (949) 347-0717

Europe

France (33-1) 47407575
Germany (49-89) 460060
U.K. (44-1628) 890800

Asia/Pacific Region

Japan (81-3) 3280-4120
Hong-Kong (852) 2861 5700
Sydney (61-2) 9580 3811
Taipei (886-2) 2378-8088

Software updates

You can get software updates from the ST Internet web site <http://mcu.st.com>.
For information on firmware and hardware revisions, call your distributor or ST using the contact list given above.

Hardware spare parts

Most of the hardware you will require is included in the emulator kit. However, some special applications may require additional parts, such as connecting an external clock, or you may need additional sockets for your application board.

Below is a list of manufacturers and dealers of SMB and BNC connectors that can be used with our product.

European manufacturer and product references:

Radiall

For worldwide sales locations,
visit Radiall's website at:

www.radiall.com

The EXTERNAL clock male connector on the emulation probe has the following commercial reference:

- In SMB range: Ref.: 114665.

Adaptable Female connectors that fit this connector are:

- SMB upright range
Ref.: 114005 for cable 2,6.
Ref.: 114003 for cable 4,2.
Ref.: 114009 for cable 3,8.
- SMB kneed range
Ref.: 114165 for cable 2,6.
Ref.: 114163 for cable 4,2.
- SMB to BNC range
Ref.: 191214. Adapter SMB female / BNC male.
Ref.: 191215. Adapter SMB female/ BNC female.

USA manufacturer

and product references

R-Tek

411 Quentin Road

Palatine, IL 60067

Phone: (847) 934-7900

Fax: (847) 934-7946

Adaptable female connector part numbers:

- CCAX00168-2: cable length 2 ft, with SMB plug to BNC plug.
- CCAX00168-3: cable length 3 ft, with SMB plug to BNC plug.

Yamaichi sockets

You can order additional Yamaichi QFP sockets directly from Yamaichi at:

http://www.yamaichi.de/Pu/quad_flat_pack/spec/a21-ic149.htm

Index

A

Active Probe	
architecture	49
hardware	49
analyser probe signals	53

C

clock	
selecting frequency	55
selecting source	55
configuration	
analyser probe input signals	53
output triggers	51
connections	
emulator power supply	19
emulator to PC	14
probe to emulator	15

E

ECP	
definition of	63
EMC compliance	15
EMC compliancy	
requirements for	57
emulator kit	
configuration of	6
delivery checklist	11
functional limitations/discrepancies	55
installing software for	21
main features of	47
main functions of	5
operation of	7
software and documentation for	8

F

ferrites	
attaching to cables	15
finished goods	
manipulation of	57
safety requirements	57
functional discrepancies	55

H

hardware	
installation	13
testing	60

I

input signals	53
installation	
hardware	13
STVD7	21

L

LEDs	54
load	
binary files	33
low voltage detection	55

M

MCU	
emulated	5
on-chip peripherals	55
MCU configuration	40
MCU memory	
configuring	42
types	42

O

on-chip peripherals	55
option byte limitations	55
output triggers	51

P

parallel port	
troubleshooting connection problems	59
passive probe	
definition of	63
PC	
connecting emulator to	14
system requirements	11
peripherals	
configuring target	41

Index

power supply limitations	55
project settings	
modifying.....	35

R

RAM	
minimum	11
ROM size	42

S

safety requirements	57
software	
updates	66
ST7MDTU5 EMU2B	
architecture	48
main features of	47
specific features of	47
STVD7	
about.....	23
build context.....	39
contexts.....	39
creating a workspace	28
debug mode	39
installing	21
main features	23
MCU configuration	40
opening binary files	33
opening workspaces	30
supported application files	25
supported toolchains.....	25

switching between contexts.....	40
toolchain paths	23
workspaces.....	24
support	
contact numbers for	65
for development kit	65
information required.....	65
web address	9

T

target device	
definition of	64
emulation discrepancies	6
supported.....	5
TQFP64 package	
connecting	17, 18
troubleshooting	59
connection error.....	59

U

user application board	
definition of	64

W

working environment recommendations.....	57
workspaces	
creating new	28
saving	37

Information furnished is believed to be accurate and reliable. However, STMicroelectronics assumes no responsibility for the consequences of use of such information nor for any infringement of patents or other rights of third parties which may result from its use. No license is granted by implication or otherwise under any patent or patent rights of STMicroelectronics. Specifications mentioned in this publication are subject to change without notice. This publication supersedes and replaces all information previously supplied. STMicroelectronics products are not authorized for use as critical components in life support devices or systems without the express written approval of STMicroelectronics.

The ST logo is a registered trademark of STMicroelectronics.

Intel® is a U.S. registered trademark of Intel Corporation.

Microsoft®, Windows® and Windows NT® are U.S. registered trademarks of Microsoft Corporation.

©2002 STMicroelectronics - All Rights Reserved.

Purchase of I²C Components by STMicroelectronics conveys a license under the Philips I²C Patent. Rights to use these components in an I²C system is granted provided that the system conforms to the I²C Standard Specification as defined by Philips.

STMicroelectronics Group of Companies

Australia - Brazil - China - Finland - France - Germany - Hong Kong - India - Italy - Japan - Malaysia - Malta - Morocco - Singapore - Spain
Sweden - Switzerland - United Kingdom - U.S.A.