

Excellent Integrated System Limited

Stocking Distributor

Click to view price, real time Inventory, Delivery & Lifecycle Information:

[Vishay Semiconductor/Opto Division](#)
[TESP5700](#)

For any questions, you can email us directly:

sales@integrated-circuit.com



TESP5700

Vishay Semiconductors

Silicon PIN Photodiode, RoHS Compliant

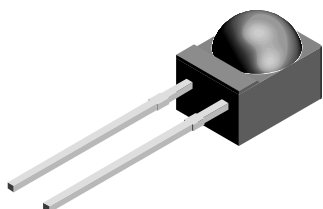

16936

DESCRIPTION

TESP5700 PIN photodiode is applicable to high speed data transmission specifically at low reverse voltage. Black epoxy package include side view lens and daylight blocking filter, matched to high speed IR emitters.

FEATURES

- Package type: leaded
- Package form: side view
- Dimensions (L x W x H in mm): 4.5 x 5 x 6
- Radiant sensitive area (in mm²): 2.2
- High radiant sensitivity
- Daylight blocking filter matched with 870 nm to 950 nm emitters
- High cut-off frequency at $V_R = 2\text{ V}$: 35 MHz
- Angle of half sensitivity: $\phi = \pm 60^\circ$
- Lead (Pb)-free component in accordance with RoHS 2002/95/EC and WEEE 2002/96/EC



RoHS
COMPLIANT

APPLICATIONS

- High speed data transmission specifically using low supply voltage
- High speed detector for infrared radiation
- Infrared remote control and free air data transmissionsystems, e.g. in combination with TSFFxxxx series IR emitters

PRODUCT SUMMARY

COMPONENT	I_{ra} (μA)	ϕ (deg)	$\lambda_{0.5}$ (nm)
TESP5700	25	± 60	790 to 980

Note

Test condition see table "Basic Characteristics"

ORDERING INFORMATION

ORDERING CODE	PACKAGING	REMARKS	PACKAGE FORM
TESP5700	Bulk	MOQ: 4000 pcs, 4000 pcs/bulk	Side view

Note

MOQ: minimum order quantity

ABSOLUTE MAXIMUM RATINGS

PARAMETER	TEST CONDITION	SYMBOL	VALUE	UNIT
Reverse voltage		V_R	60	V
Power dissipation	$T_{amb} \leq 25^\circ\text{C}$	P_V	215	mW
Junction temperature		T_j	100	$^\circ\text{C}$
Operating temperature range		T_{amb}	- 40 to + 100	$^\circ\text{C}$
Storage temperature range		T_{stg}	- 40 to + 100	$^\circ\text{C}$
Soldering temperature	$t \leq 5\text{ s}$	T_{sd}	260	$^\circ\text{C}$
Thermal resistance junction/ambient	Connected with Cu wire, 0.14 mm ²	R_{thJA}	350	K/W

Note

$T_{amb} = 25^\circ\text{C}$, unless otherwise specified

TESP5700

Vishay Semiconductors

Silicon PIN Photodiode, RoHS Compliant



BASIC CHARACTERISTICS						
PARAMETER	TEST CONDITION	SYMBOL	MIN.	TYP.	MAX.	UNIT
Forward voltage	$I_F = 50 \text{ mA}$	V_F		0.9	1.3	V
Breakdown voltage	$I_R = 100 \text{ }\mu\text{A}, E = 0$	$V_{(BR)}$	60			V
Reverse dark current	$V_R = 10 \text{ V}, E = 0$	I_{ro}		1	10	nA
Diode capacitance	$V_R = 0 \text{ V}, f = 1 \text{ MHz}, E = 0$	C_D		17		pF
Serial resistance	$V_R = 2 \text{ V}, f = 1 \text{ MHz}$	R_S		40		Ω
Open circuit voltage	$E_e = 1 \text{ mW/cm}^2, \lambda = 870 \text{ nm}$	V_o		430		mV
Temperature coefficient of V_o	$E_e = 1 \text{ mW/cm}^2, \lambda = 870 \text{ nm}$	TK_{V_o}		- 2.6		mV/K
Short circuit current	$E_e = 1 \text{ mW/cm}^2, \lambda = 870 \text{ nm}$	I_k		23		μA
Reverse light current	$E_e = 1 \text{ mW/cm}^2, \lambda = 870 \text{ nm}, V_R = 2 \text{ V}$	I_{ra}	16	25		μA
Temperature coefficient of I_{ra}	$E_e = 1 \text{ mW/cm}^2, \lambda = 870 \text{ nm}, V_R = 2 \text{ V}$	$TK_{I_{ra}}$		0.13		%/K
Absolute spectral sensitivity	$V_R = 2 \text{ V}, \lambda = 870 \text{ nm}$	$s(\lambda)$		0.57		A/W
	$V_R = 5 \text{ V}, \lambda = 950 \text{ nm}$	$s(\lambda)$		0.37		A/W
Angle of half sensitivity		φ		± 60		deg
Wavelength of peak sensitivity		λ_p		870		nm
Range of spectral bandwidth		$\lambda_{0.5}$		790 to 980		nm
Rise time	$V_R = 2 \text{ V}, R_L = 50 \text{ }\Omega, \lambda = 870 \text{ nm}$	t_r		10		ns
Fall time	$V_R = 2 \text{ V}, R_L = 50 \text{ }\Omega, \lambda = 870 \text{ nm}$	t_f		10		ns
Cut-off frequency	$V_R = 2 \text{ V}, R_L = 50 \text{ }\Omega, \lambda = 870 \text{ nm}$	f_c		35		MHz

Note

$T_{amb} = 25 \text{ }^\circ\text{C}$, unless otherwise specified

BASIC CHARACTERISTICS

$T_{amb} = 25 \text{ }^\circ\text{C}$, unless otherwise specified

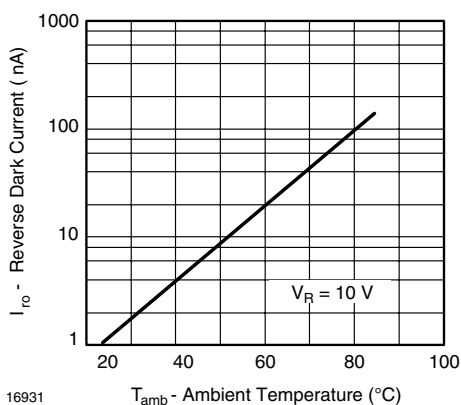

Fig. 1 - Reverse Dark Current vs. Ambient Temperature

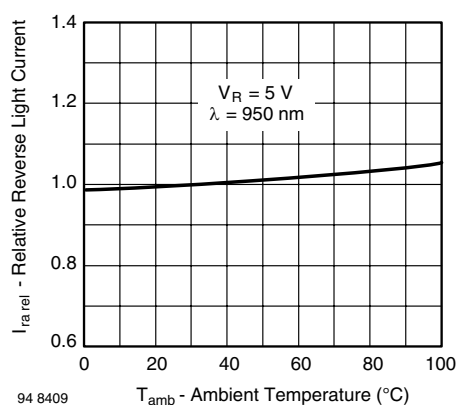
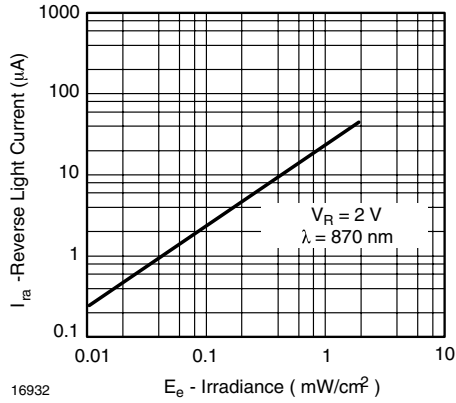

Fig. 2 - Relative Reverse Light Current vs. Ambient Temperature



TESP5700

Silicon PIN Photodiode, RoHS Compliant Vishay Semiconductors



16932
Fig. 3 - Reverse Light Current vs. Irradiance

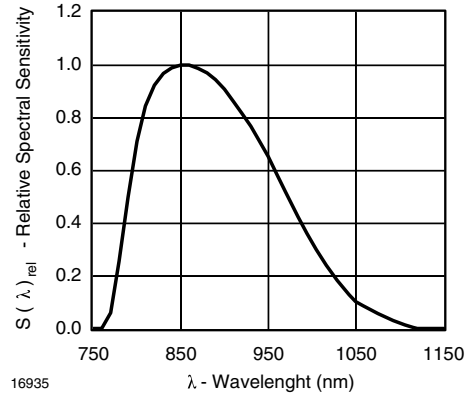

16935
Fig. 6 - Relative Spectral Sensitivity vs. Wavelength

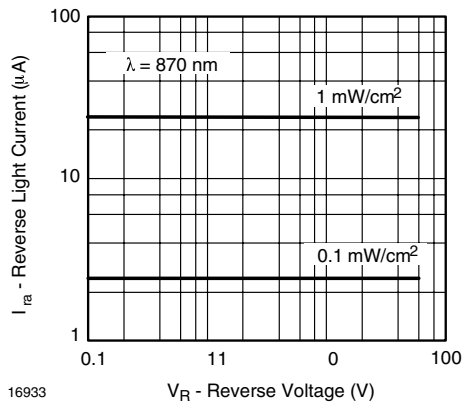

16933
Fig. 4 - Reverse Light Current vs. Reverse Voltage

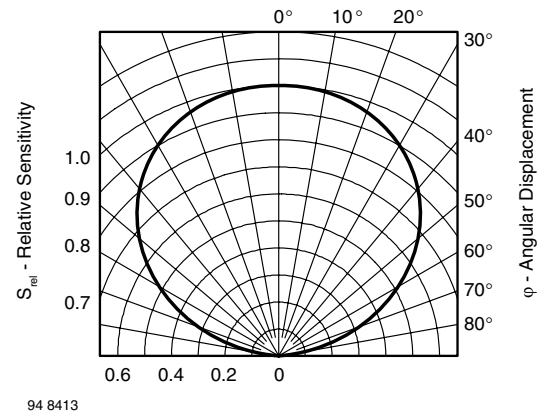

94 8413
Fig. 7 - Relative Radiant Sensitivity vs. Angular Displacement

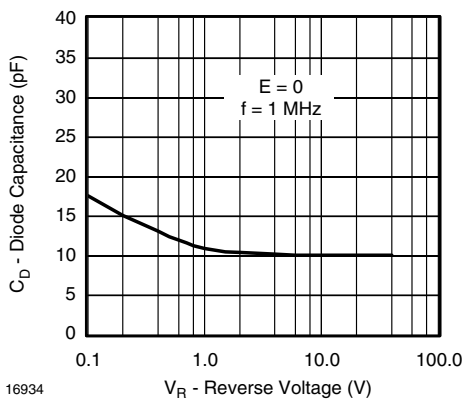

16934
Fig. 5 - Diode Capacitance vs. Reverse Voltage

TESP5700

Vishay Semiconductors

Silicon PIN Photodiode, RoHS Compliant



PACKAGE DIMENSIONS in millimeters

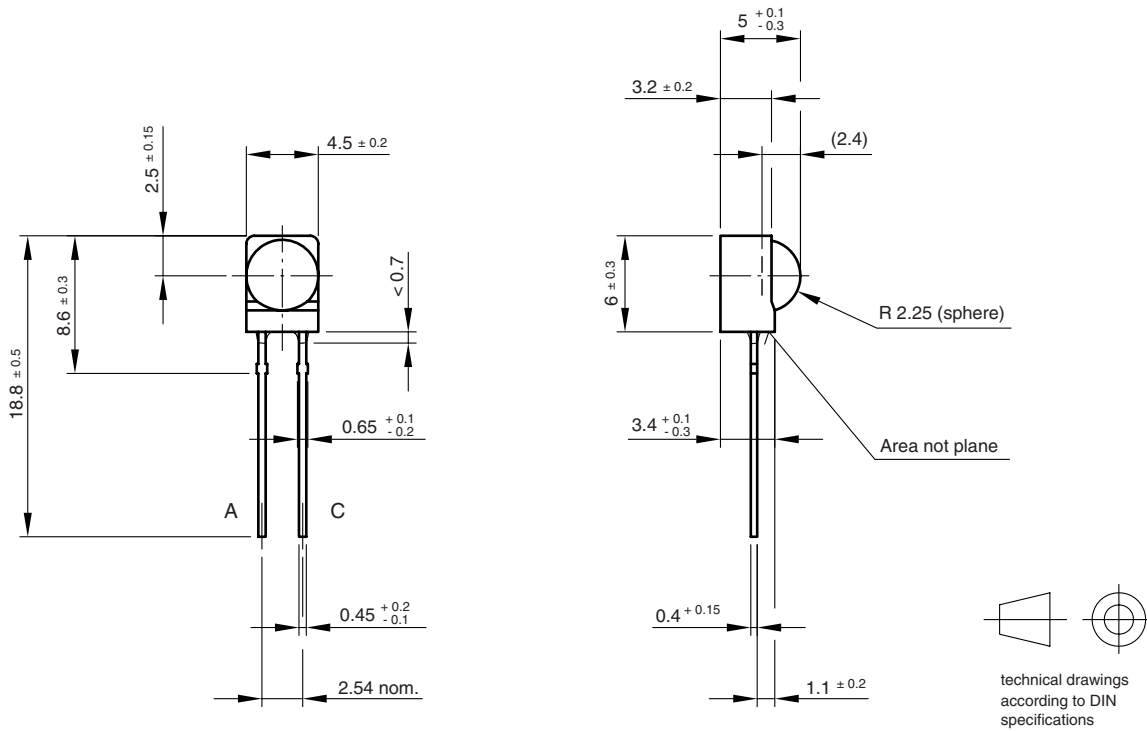

Drawing-No.: 6.544-5199.01-4

Issue: 2; 19.06.01

95 11475



Legal Disclaimer Notice

Vishay

Disclaimer

All product specifications and data are subject to change without notice.

Vishay Intertechnology, Inc., its affiliates, agents, and employees, and all persons acting on its or their behalf (collectively, "Vishay"), disclaim any and all liability for any errors, inaccuracies or incompleteness contained herein or in any other disclosure relating to any product.

Vishay disclaims any and all liability arising out of the use or application of any product described herein or of any information provided herein to the maximum extent permitted by law. The product specifications do not expand or otherwise modify Vishay's terms and conditions of purchase, including but not limited to the warranty expressed therein, which apply to these products.

No license, express or implied, by estoppel or otherwise, to any intellectual property rights is granted by this document or by any conduct of Vishay.

The products shown herein are not designed for use in medical, life-saving, or life-sustaining applications unless otherwise expressly indicated. Customers using or selling Vishay products not expressly indicated for use in such applications do so entirely at their own risk and agree to fully indemnify Vishay for any damages arising or resulting from such use or sale. Please contact authorized Vishay personnel to obtain written terms and conditions regarding products designed for such applications.

Product names and markings noted herein may be trademarks of their respective owners.