

Excellent Integrated System Limited

Stocking Distributor

Click to view price, real time Inventory, Delivery & Lifecycle Information:

[Vishay Semiconductor/Opto Division](#)
[TSSS2600](#)

For any questions, you can email us directly:

sales@integrated-circuit.com



www.vishay.com

TSSS2600

Vishay Semiconductors

Infrared Emitting Diode, 950 nm, GaAs

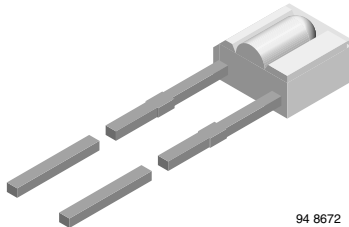

94 8672

DESCRIPTION

TSSS2600 is an infrared, 950 nm emitting diode in GaAs technology, molded in a miniature, clear plastic package with side view lens.

FEATURES

- Package type: leaded
- Package form: side view
- Dimensions (L x W x H in mm): 3.6 x 2.2 x 5
- Peak wavelength: $\lambda_p = 950$ nm
- High reliability
- High radiant power
- High radiant intensity
- Angle of half intensity: $\phi = \pm 25^\circ$, horizontal
- Low forward voltage
- Suitable for high pulse current operation
- Good spectral matching with Si photodetectors
- Package matched with detector TEST2600
- Compliant to RoHS Directive 2002/95/EC and in accordance to WEEE 2002/96/EC



RoHS
COMPLIANT
GREEN
(5-2008)**

Note

** Please see document "Vishay Material Category Policy":
www.vishay.com/doc?99902

APPLICATIONS

- Infrared source in miniature light barriers or reflective sensor systems with short transmission distances and low forward voltage requirements. Matching with silicon PIN photodiodes or phototransistors (e.g. TEST2600)

PRODUCT SUMMARY

COMPONENT	I_e (mW/sr)	ϕ (deg)	λ_p (nm)	tr (ns)
TSSS2600	2.6	± 25	950	800

Note

- Test conditions see table "Basic Characteristics"

ORDERING INFORMATION

ORDERING CODE	PACKAGING	REMARKS	PACKAGE FORM
TSSS2600	Bulk	MOQ: 5000 pcs, 5000 pcs/bulk	Side view

Note

- MOQ: minimum order quantity

ABSOLUTE MAXIMUM RATINGS ($T_{amb} = 25^\circ\text{C}$, unless otherwise specified)

PARAMETER	TEST CONDITION	SYMBOL	VALUE	UNIT
Reverse voltage		V_R	5	V
Forward current		I_F	100	mA
Peak forward current	$t_p/T = 0.5$, $t_p = 100 \mu\text{s}$	I_{FM}	200	mA
Surge forward current	$t_p = 100 \mu\text{s}$	I_{FSM}	2.0	A
Power dissipation		P_V	170	mW
Junction temperature		T_j	100	$^\circ\text{C}$
Operating temperature range		T_{amb}	- 40 to + 100	$^\circ\text{C}$
Storage temperature range		T_{stg}	- 40 to + 100	$^\circ\text{C}$
Soldering temperature	$t \leq 5$ s, 2 mm from case	T_{sd}	260	$^\circ\text{C}$
Thermal resistance junction/ambient	Leads not soldered	R_{thJA}	450	K/W



www.vishay.com

TSSS2600

Vishay Semiconductors

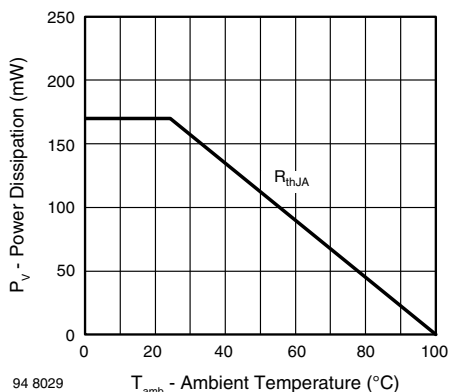

Fig. 1 - Power Dissipation Limit vs. Ambient Temperature

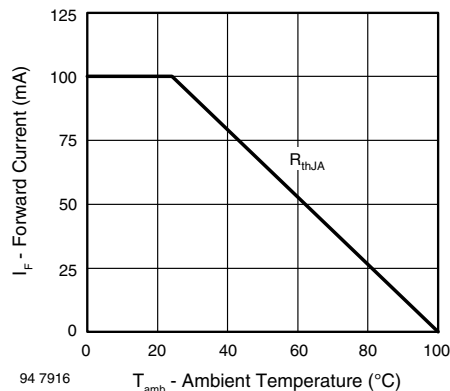

Fig. 1 - Forward Current Limit vs. Ambient Temperature

BASIC CHARACTERISTICS (T _{amb} = 25 °C, unless otherwise specified)						
PARAMETER	TEST CONDITION	SYMBOL	MIN.	TYP.	MAX.	UNIT
Forward voltage	I _F = 100 mA, t _p = 20 ms	V _F		1.25	1.6	V
	I _F = 1.5 A, t _p = 100 μs	V _F		2.2		V
Temperature coefficient of V _F	I _F = 100 mA	TK _{V_F}		- 1.3		mV/K
Reverse current	V _R = 5 V	I _R			100	μA
Junction capacitance	V _R = 0 V, f = 1 MHz, E = 0	C _j		30		pF
Radiant intensity	I _F = 100 mA, t _p = 20 ms	I _e	1	2.6	3	mW/sr
	I _F = 1.5 A, t _p = 100 μs	I _e		25		mW/sr
Radiant power	I _F = 100 mA, t _p = 20 ms	φ _e		20		mW
Temperature coefficient of φ _e	I _F = 100 mA	TKφ _e		- 0.8		%/K
Angle of half intensity	horizontal	φ ₁		± 25		deg
	vertical	φ ₂		± 60		deg
Peak wavelength	I _F = 100 mA	λ _p		950		nm
Spectral bandwidth	I _F = 100 mA	Δλ		50		nm
Temperature coefficient of λ _p	I _F = 100 mA	TKλ _p		0.2		nm/K
Rise time	I _F = 100 mA	t _r		800		ns
	I _F = 1.5 A	t _r		400		ns
Fall time	I _F = 100 mA	t _f		800		ns
	I _F = 1.5 A	t _f		400		ns
Virtual source diameter		d		2		mm



www.vishay.com

TSSS2600

Vishay Semiconductors

BASIC CHARACTERISTICS ($T_{amb} = 25\text{ }^{\circ}\text{C}$, unless otherwise specified)

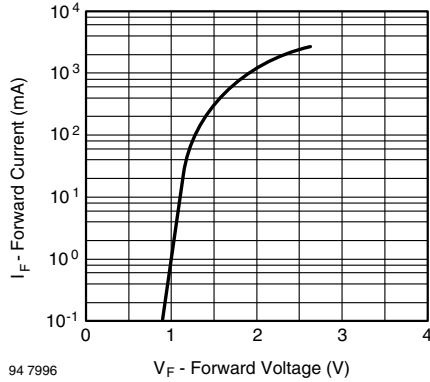

Fig. 2 - Pulse Forward Current vs. Forward Voltage

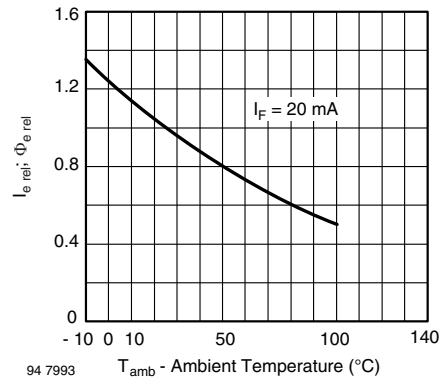

Fig. 5 - Relative Radiant Intensity/Power vs. Ambient Temperature

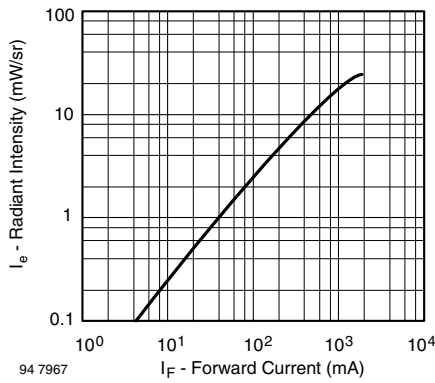

Fig. 3 - Radiant Intensity vs. Forward Current

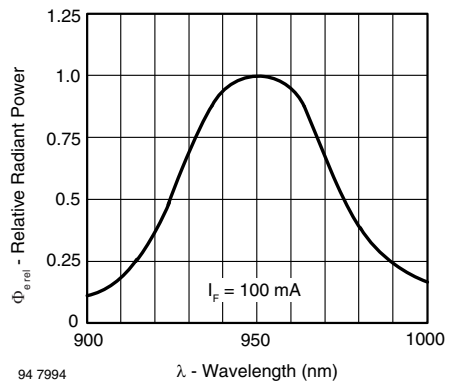

Fig. 6 - Relative Radiant Power vs. Wavelength

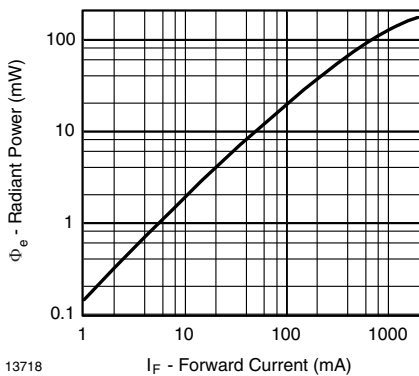

Fig. 4 - Radiant Power vs. Forward Current

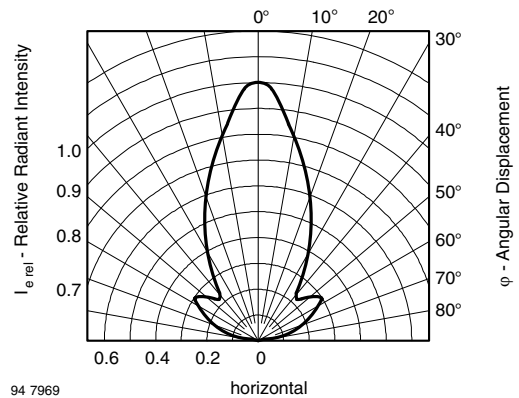

Fig. 7 - Relative Radiant Intensity vs. Angular Displacement



www.vishay.com

TSSS2600

Vishay Semiconductors

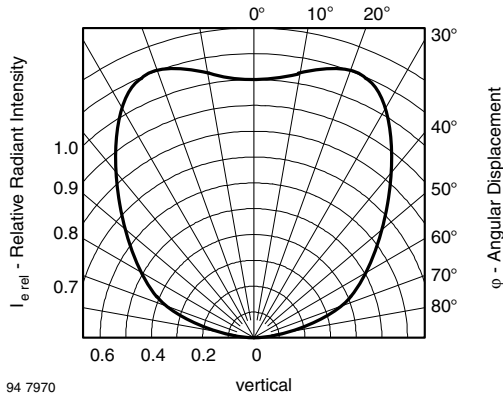
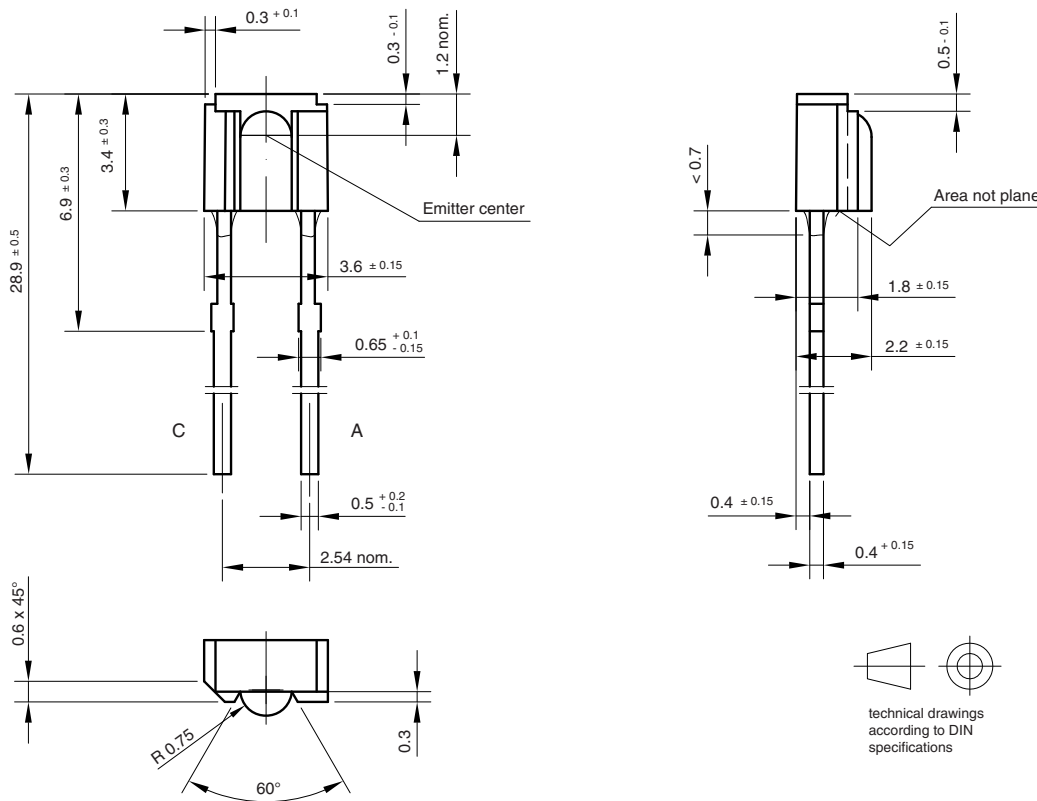

Fig. 2 - Relative Radiant Intensity vs. Angular Displacement

PACKAGE DIMENSIONS in millimeters



Drawing-No.: 6.544-5241.01-4
 Issue: 3; 18.04.96
 95 11488



Disclaimer

ALL PRODUCT, PRODUCT SPECIFICATIONS AND DATA ARE SUBJECT TO CHANGE WITHOUT NOTICE TO IMPROVE RELIABILITY, FUNCTION OR DESIGN OR OTHERWISE.

Vishay Intertechnology, Inc., its affiliates, agents, and employees, and all persons acting on its or their behalf (collectively, "Vishay"), disclaim any and all liability for any errors, inaccuracies or incompleteness contained in any datasheet or in any other disclosure relating to any product.

Vishay makes no warranty, representation or guarantee regarding the suitability of the products for any particular purpose or the continuing production of any product. To the maximum extent permitted by applicable law, Vishay disclaims (i) any and all liability arising out of the application or use of any product, (ii) any and all liability, including without limitation special, consequential or incidental damages, and (iii) any and all implied warranties, including warranties of fitness for particular purpose, non-infringement and merchantability.

Statements regarding the suitability of products for certain types of applications are based on Vishay's knowledge of typical requirements that are often placed on Vishay products in generic applications. Such statements are not binding statements about the suitability of products for a particular application. It is the customer's responsibility to validate that a particular product with the properties described in the product specification is suitable for use in a particular application. Parameters provided in datasheets and / or specifications may vary in different applications and performance may vary over time. All operating parameters, including typical parameters, must be validated for each customer application by the customer's technical experts. Product specifications do not expand or otherwise modify Vishay's terms and conditions of purchase, including but not limited to the warranty expressed therein.

Except as expressly indicated in writing, Vishay products are not designed for use in medical, life-saving, or life-sustaining applications or for any other application in which the failure of the Vishay product could result in personal injury or death. Customers using or selling Vishay products not expressly indicated for use in such applications do so at their own risk. Please contact authorized Vishay personnel to obtain written terms and conditions regarding products designed for such applications.

No license, express or implied, by estoppel or otherwise, to any intellectual property rights is granted by this document or by any conduct of Vishay. Product names and markings noted herein may be trademarks of their respective owners.