

Excellent Integrated System Limited

Stocking Distributor

Click to view price, real time Inventory, Delivery & Lifecycle Information:

[Molex Connector Corporation](#)
[0008560108](#)

For any questions, you can email us directly:

sales@integrated-circuit.com

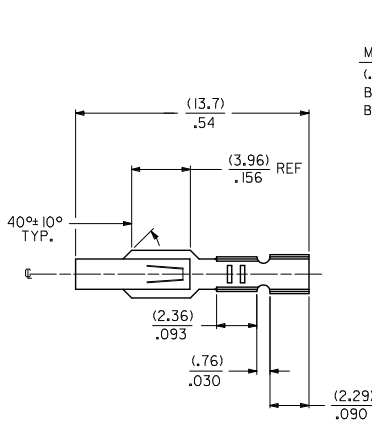
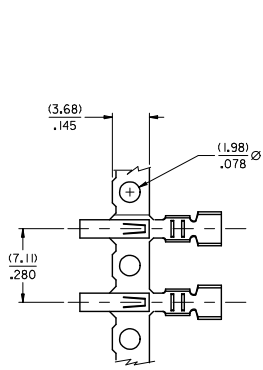

MATERIAL CODE
 (.28)/.0106 THK
 BLANK=BRASS
 B=PHOS BRONZE

2578 - * - * * *
 WINDING SPEC.
 A=CHAIN, PER WINDING DETAIL "A"
 BLANK=CHAIN, PER WINDING DETAIL "B"
 L=LOOSE

PLATING CODE
 (PER SDES-88)

OPTIONS
 BLANK=AS SHOWN
 1 = WITH CAT EARS

(122) - OVERALL TIN: (0.00381)/.000150 MIN.
 OVER (0.00076)/.000030 MIN. NICKEL
 (154) - OVERALL TIN (0.00254)/.000100 MIN.
 OVER (0.00127)/.000050 MIN. NICKEL
 (224) - OVERALL MATTE TIN: (0.00508)/.000200 MIN.
 OVER (0.00127)/.000050 MIN. NICKEL
 (550) - SELECT GOLD: (0.00038)/.000015 MIN.
 OVERALL GOLD FLASH: (0.00005)/.000002 MIN.
 OVERALL NICKEL UNDERPLATE: (0.00076)/.000030 MIN.
 (555) - SELECT GOLD: (0.00038)/.000015 MIN.
 OVERALL NICKEL UNDERPLATE: (0.00076)/.000030 MIN.
 (558) - SELECT GOLD: (0.00076)/.000030 MIN.
 OVERALL GOLD FLASH: (0.00005)/.000002 MIN.
 OVERALL NICKEL UNDERPLATE: (0.00127)/.000050 MIN.
 (P909) - OVERALL HOT TIN DIP: (0.00254)/.000100 MIN

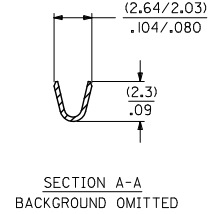
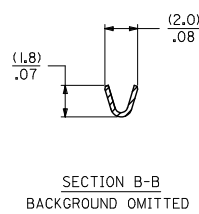
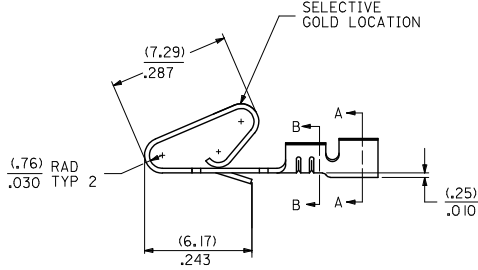
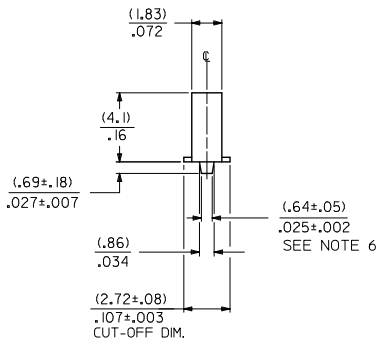

1. MATERIAL: SEE LEGEND
2. FINISH: SEE LEGEND
3. PRODUCT SPECIFICATION: PS-08-50
4. CRIMP ACCEPTS 22 TO 26 GA. WIRE WITH (1.65)/0.65 MAX INSULATION DIA.
5. DIMENSIONS GIVEN ACROSS CENTERLINES ARE SYMMETRICAL ABOUT THOSE CENTERLINES WITHIN HALF THE TOTAL TOLERANCE.
6. OPTIONAL DESIGN (.86±.05)/.034±.002
7. THIS PART CONFORMS TO CLASS B REQUIREMENTS OF COSMETIC SPECIFICATION PS-45499-002

ADD WINDING VIEW EC NO: UCP2014-4151 DRAWN BY: 2014/04/07 CHKD BY: 2014/04/07 APPROVED BY: 2014/04/21	QUALITY SYMBOLS ▽=0 ▽=0 ▽=0	GENERAL TOLERANCES (UNLESS SPECIFIED)		DIMENSION STYLE		SCALE	DESIGN UNITS	THIRD ANGLE PROJECTION
		mm	INCH	MM/IN	DATE	---	INCH	☉
X1	REV	4 PLACES	± ---	± ---	DRAWN BY	PEREZ / AR	DATE	01/29/87
		3 PLACES	± ---	± .010	CHECKED BY	DATE		
		2 PLACES	± 0.25	± .014	APPROVED BY	PATEL	DATE	01/29/87
		1 PLACE	± 0.36	± ---	MATERIAL NO.	SMITH	DATE	2014/04/21
		0 PLACE	± ---	± ---	DOCUMENT NO.			
		ANGULAR ±1/2°		SEE CHART		SD-2578		SHEET NO. 1 OF 2
		DRAFT WHERE APPLICABLE MUST REMAIN WITHIN DIMENSIONS		THIS DRAWING CONTAINS INFORMATION THAT IS PROPRIETARY TO MOLEX INCORPORATED AND SHOULD NOT BE USED WITHOUT WRITTEN PERMISSION				

2578-(****)*		2578-B-(****)*	
PART NO.	ENG. NO.	PART NO.	ENG. NO.
08-50-0107	2578-(P909)	08-50-0133	2578-B-(P909)
08-50-0108	2578-(P909)L	08-50-0134	2578-B-(P909)L
08-50-0111	2578-(154)	08-65-0116	2578-B-(555)
08-50-0112	2578-(154)L	08-65-0117	2578-B-(555)L
08-56-0107	2578-(550)	08-60-0003	2578-B-(122)
08-56-0108	2578-(550)L	08-60-0004	2578-B-(122)L
08-55-0105	2578-(555)	08-65-0110	2578-B-(558)
08-55-0106	2578-(555)L	08-65-0111	2578-B-(558)L
08-50-0061	2578-(224)	08-58-0125	2578-B-(550)
08-50-0062	2578-(224)L	08-58-0126	2578-B-(550)L
08-55-0137	2578-(558)A		
	2578-(558)L		
08-50-0018	2578-(154)		
08-50-0019	2578-(154)L		
08-55-0123	2578-(558)		
	2578-(558)L		

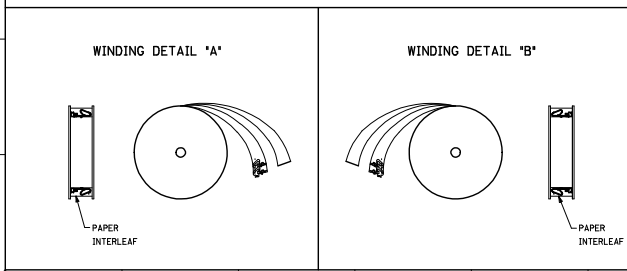
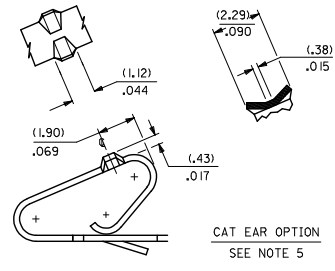

SEE SHEET 1 EC NO. UCF2014-4131 DRAWN BY: 2014/04/07 CHKD BY: 2014/04/07 APPROVED BY: 2014/04/21	QUALITY SYMBOLS ∇=0 ∇=0 ∇=0	GENERAL TOLERANCES (UNLESS SPECIFIED)		DIMENSION STYLE MM/IN		SCALE ---	DESIGN UNITS INCH	THIRD ANGLE PROJECTION
		4 PLACES ± --- ± --- 3 PLACES ± --- ± .010 2 PLACES ± 0.25 ± .014 1 PLACE ± 0.36 ± --- 0 PLACE ± --- ± ---	mm INCH DRAWN BY: PEREZ/AR DATE: 01/29/87 CHECKED BY: PATEL DATE: 01/29/87 APPROVED BY: F-SMITH DATE: 2014/04/21	TITLE CRIMP TERMINAL (3.96)/.156 CENTERS 22 TO 26 GA WIRE		MATERIAL NO. SEE CHART		DOCUMENT NO. SD-2578
DRAFT WHERE APPLICABLE MUST REMAIN WITHIN DIMENSIONS		THIS DRAWING CONTAINS INFORMATION THAT IS PROPRIETARY TO MOLEX INCORPORATED AND SHOULD NOT BE USED WITHOUT WRITTEN PERMISSION						