

Excellent Integrated System Limited

Stocking Distributor

Click to view price, real time Inventory, Delivery & Lifecycle Information:

[Kingbright](#)
[WP7104F3C](#)

For any questions, you can email us directly:

sales@integrated-circuit.com

Kingbright

T-1 (3mm) INFRARED EMITTING DIODE

PRELIMINARY SPEC

Part Number: WP7104F3C

Features

- MECHANICALLY AND SPECTRALLY MATCHED TO THE PHOTOTRANSISTOR.
- WATER CLEAR LENS.
- RoHS COMPLIANT.

Description

F3 Made with Gallium Arsenide Infrared Emitting diodes.

Package Dimensions

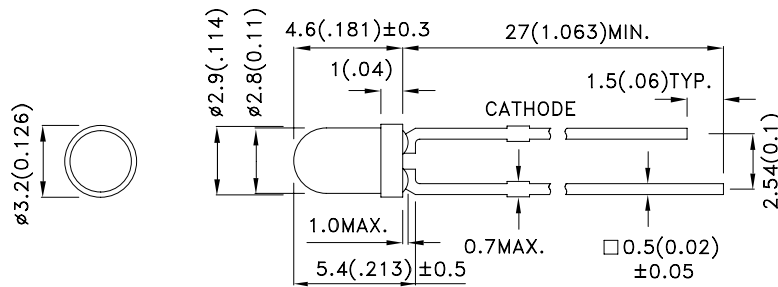

Notes:

1. All dimensions are in millimeters (inches).
2. Tolerance is $\pm 0.25(0.01)$ unless otherwise noted.
3. Lead spacing is measured where the leads emerge from the package.
4. Specifications are subject to change without notice.



Kingbright

Selection Guide

Part No.	Dice	Lens Type	Po (mW/sr) [2] @ 20mA *50mA		Viewing Angle [1]
			Min.	Typ.	2θ1/2
WP7104F3C	F3 (GaAs)	WATER CLEAR	7	30	34°
			*18	*80	

Notes:

1. θ1/2 is the angle from optical centerline where the luminous intensity is 1/2 the optical centerline value.
2. * Luminous intensity with asterisk is measured at 50mA; Radiant Intensity/ luminous flux: +/-15%.

Electrical / Optical Characteristics at TA=25°C

Parameter	P/N	Symbol	Typ.	Max.	Units	Test Conditions
Forward Voltage [1]	F3	V _F	1.2	1.6	V	I _F =20mA
Reverse Current	F3	I _R		10	uA	V _R = 5V
Capacitance	F3	C	90		pF	V _F =0V;f=1MHz
Peak Spectral Wavelength	F3	λ _P	940		nm	I _F =20mA
Spectral Bandwidth	F3	Δλ1/2	50		nm	I _F =20mA

Note:

1. Forward Voltage: +/-0.1V.

Absolute Maximum Ratings at TA=25°C

Parameter	Symbol	F3	Units
Power dissipation	P _T	80	mW
DC Forward Current	I _F	50	mA
Peak Forward Current [1]	i _{FS}	1.2	A
Reverse Voltage	V _R	5	V
Operating Temperature	T _A	-40 To +85	°C
Storage Temperature	T _{STG}	-40 To +85	°C
Lead Solder Temperature [2]	260°C For 3 Seconds		
Lead Solder Temperature [3]	260°C For 5 Seconds		

Notes:

1. 1/10 Duty Cycle, 0.1ms Pulse Width.
2. 2mm below package base.
3. 5mm below package base.

Kingbright

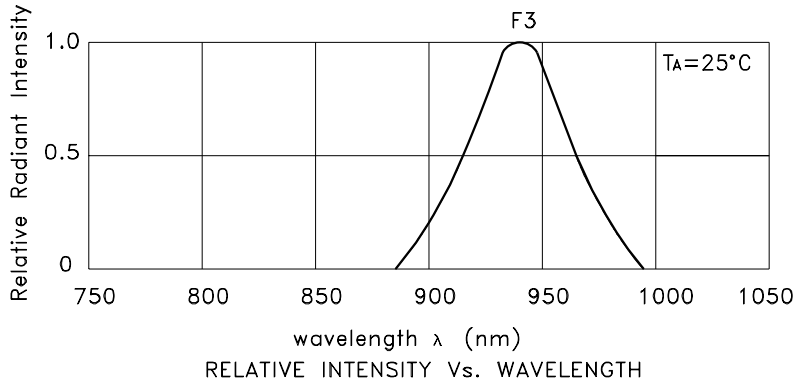

WP7104F3C

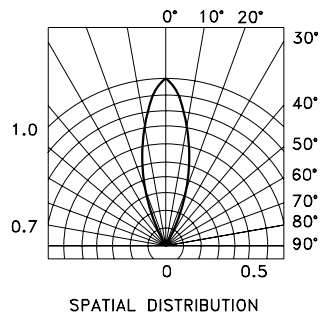
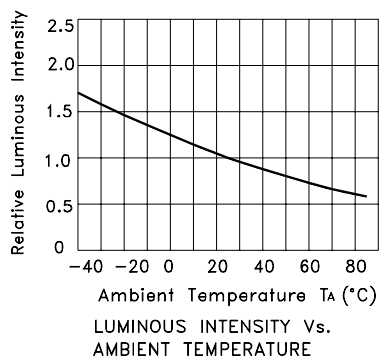
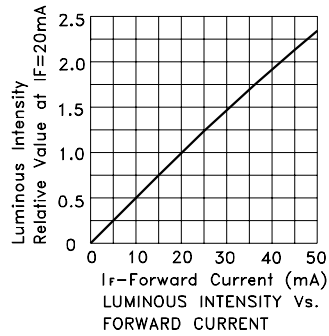
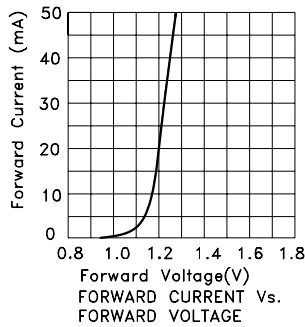

Kingbright

PACKING & LABEL SPECIFICATIONS

WP7104F3C

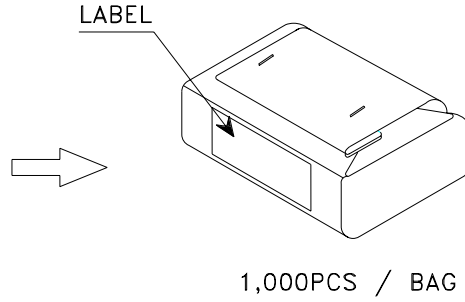
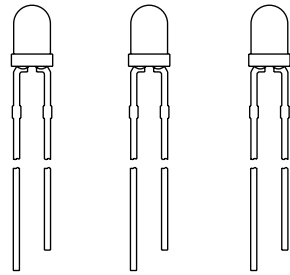

OUTSIDE LABEL

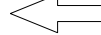

OUTSIDE LABEL

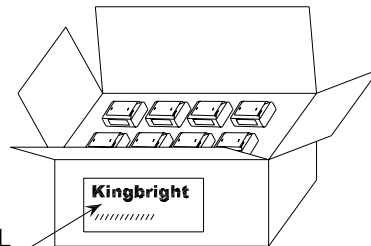

28K / 5# BOX

Kingbright	
Q.C.	QC XX XX XX PASSED
TYPE NO : WP7104xxx	
QUANTITY : 1,000 pcs	
S/N : XX	CODE: XX
LOT NO :  XX-XXXX	
RoHS Compliant	

Kingbright

LED MOUNTING METHOD

1. The lead pitch of the LED must match the pitch of the mounting holes on the PCB during component placement. Lead-forming may be required to insure the lead pitch matches the hole pitch. Refer to the figure below for proper lead forming procedures.

(Fig. 1)

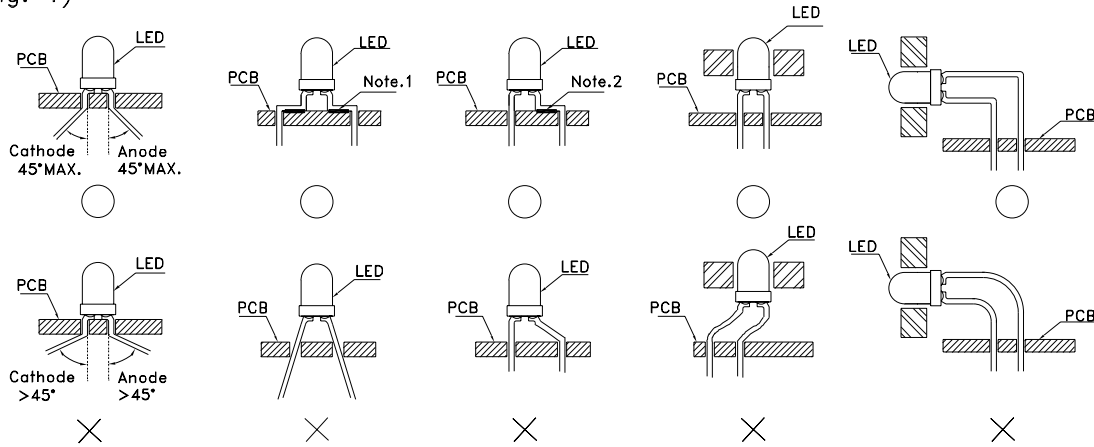

Fig. 1

”O” Correct mounting method ”X” Incorrect mounting method

Note 1-2 : Do not route PCB trace in the contact area between the leadframe and the PCB to prevent short-circuits.

2. When soldering wire to the LED, use individual heat-shrink tubing to insulate the exposed leads to prevent accidental contact short-circuit.

(Fig. 2)

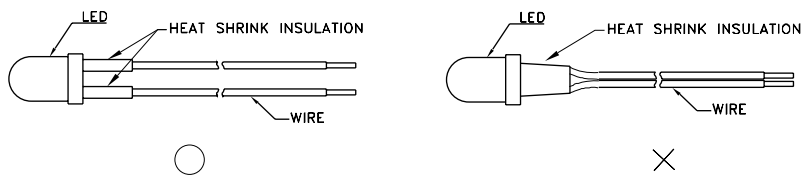

Fig. 2

3. Use stand-offs (Fig. 3) or spacers (Fig. 4) to securely position the LED above the PCB.

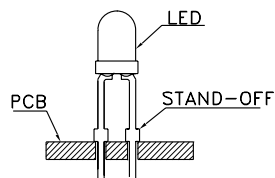

Fig. 3

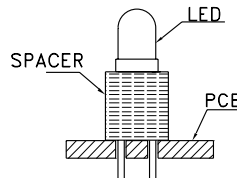

Fig. 4

Kingbright

LEAD FORMING PROCEDURES

1. Maintain a minimum of 2mm clearance between the base of the LED lens and the first lead bend. (Fig. 5 and 6)

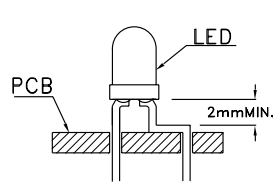

Fig. 5

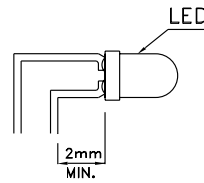

Fig. 6

2. Lead forming or bending must be performed before soldering, never during or after Soldering.
3. Do not stress the LED lens during lead-forming in order to fractures in the lens epoxy and damage the internal structures.
4. During lead forming, use tools or jigs to hold the leads securely so that the bending force will not be transmitted to the LED lens and its internal structures. Do not perform lead forming once the component has been mounted onto the PCB. (Fig. 7)
5. Do not bend the leads more than twice. (Fig. 8)

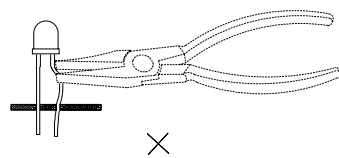

Fig. 7

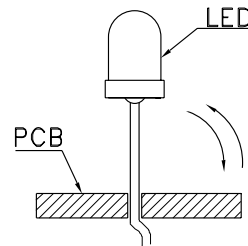

Fig. 8

6. After soldering or other high-temperature assembly, allow the LED to cool down to 50°C before applying outside force (Fig. 9). In general, avoid placing excess force on the LED to avoid damage. For any questions please consult with Kingbright representative for proper handling procedures.

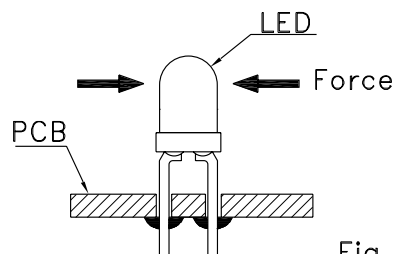

Fig. 9