

## Excellent Integrated System Limited

Stocking Distributor

Click to view price, real time Inventory, Delivery & Lifecycle Information:

[Bel Fuse Inc.](#)  
[SRBA-03A1A0G](#)

For any questions, you can email us directly:  
[sales@integrated-circuit.com](mailto:sales@integrated-circuit.com)

## NON-ISOLATED DC/DC CONVERTERS

8.3 Vdc - 14 Vdc Input      0.75 Vdc - 5.0 Vdc/3 A Output



**SRBA-03A1Ax**

**RoHS Compliant**

**Rev.A**

- Non-Isolated
- Fixed Frequency
- High Efficiency
- High Power Density
- Active Low/High (Option)
- Under-Voltage Lockout (UVLO)
- OCP/SCP
- Remote On/Off
- Wide Trim Range
- Wide Input Range

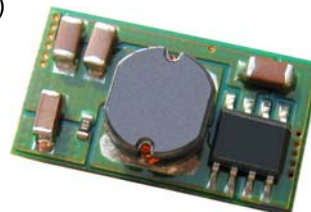

### Description

The Bel SRBA-03A1Ax modules are a series of non-isolated dc/dc converters that deliver up to 3 A of output current with full load efficiency of 93% at 5.0 Vdc output. These modules provide precisely regulated voltage programmable via external resistor from 0.75 Vdc to 5.5 Vdc over a wide range of input voltage. Their open-frame construction and small footprint enable designers to develop cost and space-efficient solutions. Standard features include remote On/Off, programmable output voltage, over-temperature protection, over current protection, short circuit protection, and under-voltage lockout.

### Part Selection

Output Voltage	Input Voltage	Max. Output Current	Max. Output Power	Typical Efficiency at 5.0V	Model Number Active High	Model Number Active Low
0.75 V - 5.0 V	8.3 V - 14 V	3 A	15 W	93%	SRBA-03A1A0	SRBA-03A1AL

- Notes:** 1. Add "G" suffix at the end of the model number to indicate Tray Packaging.  
 2. All part numbers above indicate RoHS 6. Change the second letter "R" to "7" for RoHS 5 part numbers.

### Absolute Maximum Ratings

Parameter	Min	Typ	Max	Notes
Input Voltage (continuous)	-0.3 V	-	15 V	
Output Enable Terminal Voltage	-0.3 V	-	15 V	
Ambient Temperature	-40 °C	-	85 °C	
Storage Temperature	-55 °C	-	125 °C	

**Note:** All specifications are typical at 25°C unless otherwise stated.

### Input Specifications

Parameter	Min	Typ	Max	Notes
Input Voltage	8.3 V	12 V	14 V	
Input Current (full load)				
Vo=5.0 V	-	1.35 A	2.00 A	
Vo=3.3 V	-	0.90 A	1.30 A	
Vo=0.75 V	-	0.24 A	0.35 A	
Input Current (no load)				
Vo=5.0 V	-	55 mA	65 mA	
Vo=3.3 V	-	40 mA	50 mA	
Vo=0.75 V	-	15 mA	20 mA	

## NON-ISOLATED DC/DC CONVERTERS

8.3 Vdc - 14 Vdc Input      0.75 Vdc - 5.0 Vdc/3 A Output



### Input Specifications (continued)

Parameter	Min	Typ	Max	Notes
Remote Off Input Current	-	3 mA	6 mA	
Input Reflected Ripple Current (pk-pk)				Tested with two 100 uF/25 V tantalum input capacitors & simulated source impedance of 1 uH, 5 Hz to 20 MHz.
Vo=5.0 V	-	75 mA	120 mA	
Vo=3.3 V	-	50 mA	90 mA	
Vo=0.75 V	-	20 mA	35 mA	
Input Reflected Ripple Current (rms)				
Vo=5.0 V	-	20 mA	60 mA	
Vo=3.3 V	-	15 mA	30 mA	
Vo=0.75 V	-	5 mA	15 mA	
I <sup>2</sup> t Inrush Current Transient	-	0.01 A <sup>2</sup> s	0.02 A <sup>2</sup> s	
Turn-on Voltage Threshold	7.6V	7.9 V	8.2 V	
Turn-off Voltage Threshold	7.0V	7.8 V	8.1 V	

### Output Specifications

Parameter	Min	Typ	Max	Notes
Output Voltage Set Point	-2% Vo,set	-	2% Vo,set	Vin=12 V, Io=Iomax, full load
Output Voltage Set Point	-2.5% Vo,set	-	3.5% Vo,set	Over all operating input voltages, resistive loads and temperature conditions
Load Regulation	0.5% Vo,set	0.4% Vo,set	0.5% Vo,set	Io=Iomin to Iomax
Line Regulation	0.4% Vo,set	0.3% Vo,set	0.4% Vo,set	Vin=Vinmin to Vinmax
Regulation Over Temperature (-40 °C to +85 °C)	-	0.5% Vo,set	0.8% Vo,set	
Output Current	0 A	-	3 A	
Current Limit Threshold	5 A	-	12 A	
Short Circuit Surge Transient	-	0.15 A <sup>2</sup> s	-	
Ripple and Noise (pk-pk)				Tested with 0-20 MHz, with 10 uF/10 V tantalum capacitor and 1uF/10 V ceramic capacitor at the output
Vo=5.0 V	-	65 mV	100 mV	
Vo=3.3 V	-	45 mV	80 mV	
Vo=0.75 V	-	20 mV	35 mV	
Ripple and Noise (rms)				
Vo=5.0 V	-	20 mV	40 mV	
Vo=3.3 V	-	10 mV	25 mV	
Vo=0.75 V	-	5 mV	15 mV	
Turn on Time	-	5 mS	8 mS	
Overshoot at Turn on	-	0%	3%	
Output Capacitance	0 uF	-	1200 uF	
<b>Transient Response</b>				
50% ~ 100% Max Load	All	-	200 mV	300 mV
Settling Time		-	50 uS	80 uS
100% ~ 50% Max Load		-	200 mV	300 mV
Settling Time		-	50 uS	80 uS

**Note:** All specifications are typical at nominal input (Vin=12 V), full load at 25 °C unless otherwise stated.

## NON-ISOLATED DC/DC CONVERTERS

8.3 Vdc - 14 Vdc Input

0.75 Vdc - 5.0 Vdc/3 A Output



### General Specifications

Parameter	Min	Typ	Max	Notes
Efficiency Vo=5.0 V Vo=3.3 V Vo=0.75 V	90% 88% 76%	93% 91% 80%	- - -	Measured at Vin=12 V, full load (Current Source)
Switching Frequency	-	300 kHz	-	
Over Temperature Shutdown	-	135 °C	-	
MTBF	6,740,000 hours			Calculated Per Bell Core SR-332 (Io = 80% load; Ta = 25 °C)
Dimensions (Surface Mount) Inches (L x W x H) Millimeters (L x W x H)	0.8 x 0.45 x 0.251 20.32 x 11.42 x 6.38			
Weight	-	3 g	-	

**Note:** All specifications are typical at 25 °C unless otherwise stated.

### Control Specifications

Parameter	Min	Typ	Max	Notes
<b>Remote On/Off</b>				
Signal Low (Unit Off)	-0.3 V	-	0.4 V	SRBA-03A1A0; Remote On/Off pin open, Unit on.
Signal High (Unit On)	2.5 V	-	14 V	
Signal Low (Unit On)	-0.3 V	-	0.4 V	SRBA-03A1AL; Remote On/Off pin open, Unit on.
Signal High (Unit Off)	2.5 V	-	14 V	
Output Voltage Trim Range (Wide Trim)	0.7525 V	-	5.0 V	

## NON-ISOLATED DC/DC CONVERTERS

8.3 Vdc - 14 Vdc Input

0.75 Vdc - 5.0 Vdc/3 A Output



### Remote Enable Specifications

The SRBA-03A1AL modules feature an enable pin with negative logic. If not using the enable pin, leave the pin open (the module will be on). During logic\_high, the module is turned off, during logic\_low, the module is turned on. Its inner circuit impedance is shown as figure.

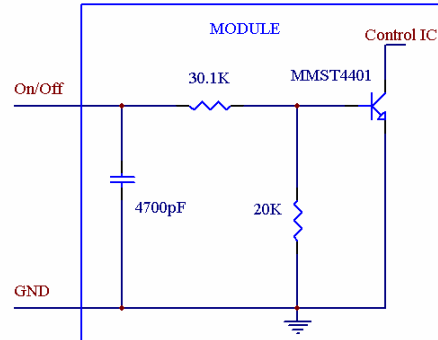

SRBA-03A1AL

The SRBA-03A1A0 modules feature an enable pin with Positive logic. If not using the enable pin, leave the pin open (the module will be on). During logic\_high, the module is turned on, during logic\_low, the module is turned off. Its inner circuit impedance is shown as figure.

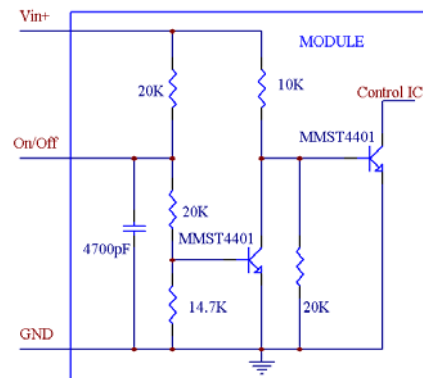

SRBA-03A1A0

### Output Trim Equations

Equation for calculating the trim resistor (in kΩ) given the desired adjusted voltage ( $V_{adj}$ ) is shown below. The Trim Up resistor should be connected between the Trim pin and Ground.

$$R_{trim} = \frac{10.507}{V_{adj} - 0.7525} - 1$$

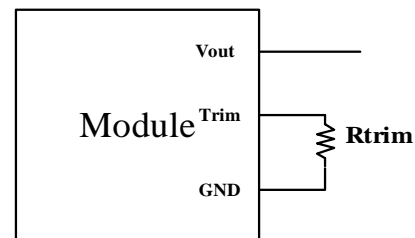

Equation for calculating the trim voltage (in V) given the desired adjusted voltage ( $V_{adj}$ ) is shown below. The Trim Up voltage should be connected between the Trim pin and Ground.

$$V_{trim} = 0.7 - 0.0667 \times (V_{adj} - 0.7525)$$

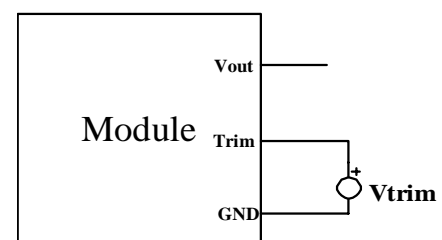

**NON-ISOLATED DC/DC CONVERTERS**  
 8.3 Vdc - 14 Vdc Input      0.75 Vdc - 5.0 Vdc/3 A Output



**Efficiency Data**

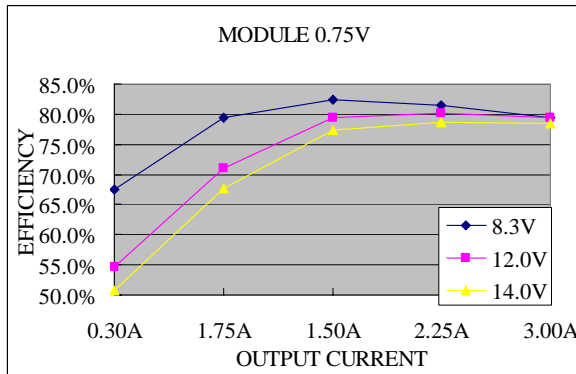
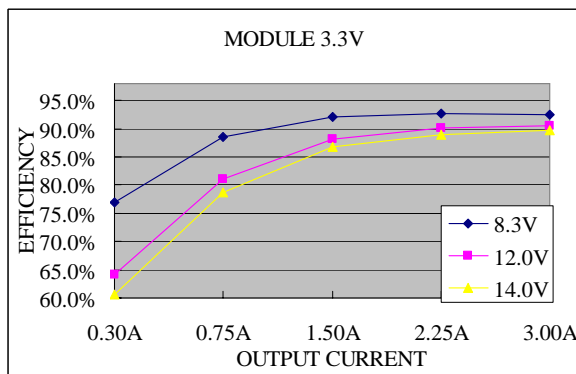
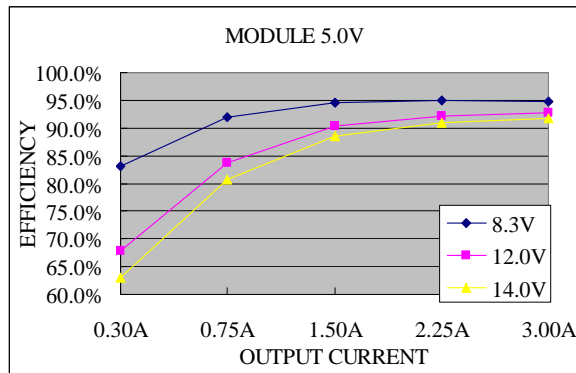

**NON-ISOLATED DC/DC CONVERTERS**

8.3 Vdc - 14 Vdc Input

0.75 Vdc - 5.0 Vdc/3 A Output



**Thermal Derating Curves**

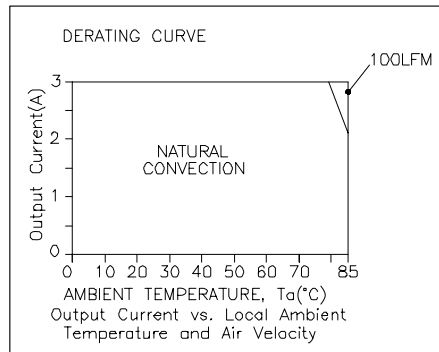

**Vin=12 V, Vo=5.0 V**

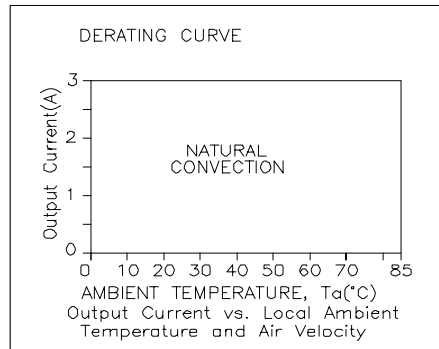

**Vin=12 V, Vo=3.3 V**

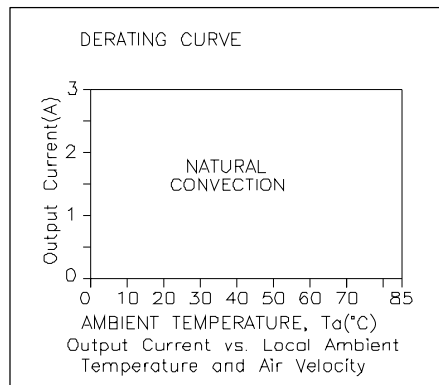

**Vin=12 V, Vo=0.75 V**

**NON-ISOLATED DC/DC CONVERTERS**

8.3 Vdc - 14 Vdc Input

0.75 Vdc - 5.0 Vdc/3 A Output



**Ripple and Noise Waveforms**

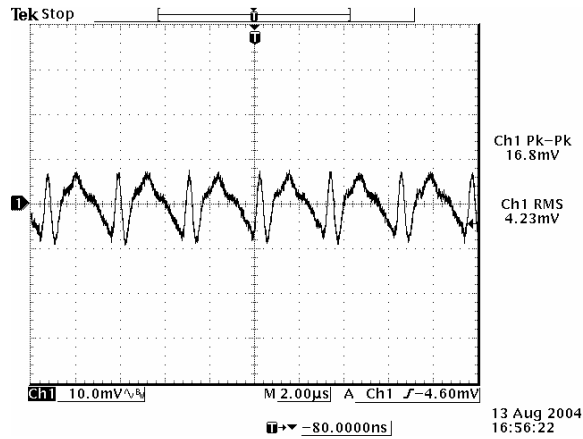

12 Vdc input, 0.75 Vdc output

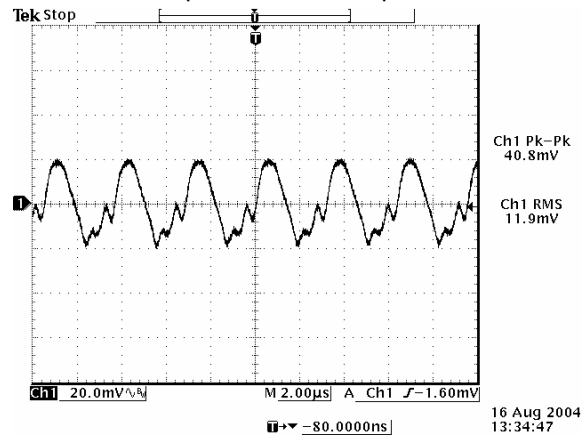

12 Vdc input, 3.3 Vdc output

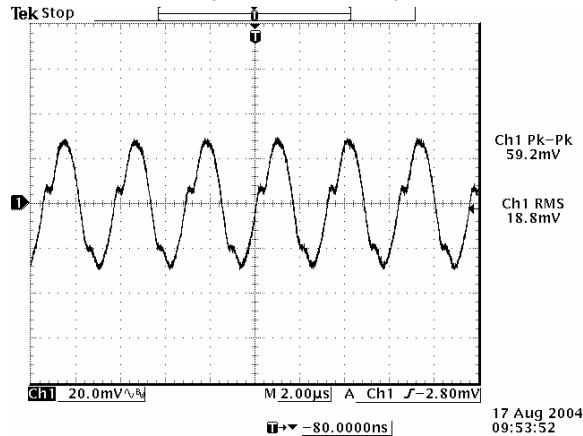

12 Vdc input, 5.0 Vdc output

**Note:** Ripple and noise at full load, 0-20 MHz BW, with 10 uF/10 V tantalum cap and 1 uF/10 V ceramic cap at the output, and Ta=25 deg C.



**NON-ISOLATED DC/DC CONVERTERS**  
 8.3 Vdc - 14 Vdc Input      0.75 Vdc - 5.0 Vdc/3 A Output



**Transient Response Waveforms**

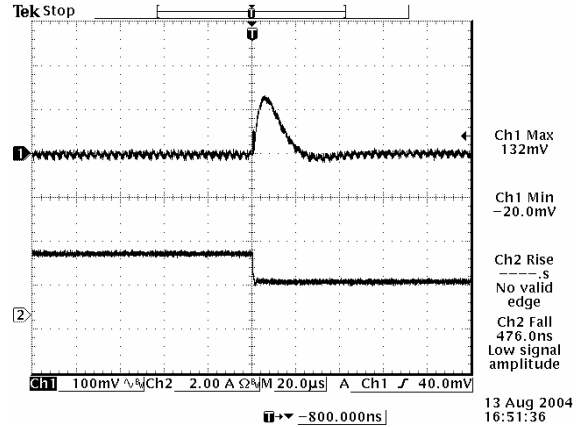
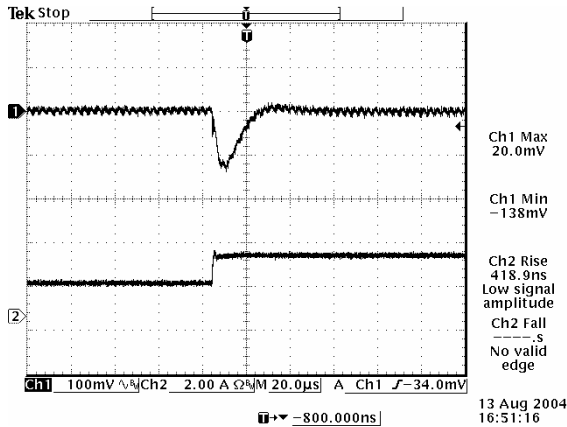

Transients 50% to 100% load 0.75 Vdc output

Transients 100% to 50% load 0.75 Vdc output

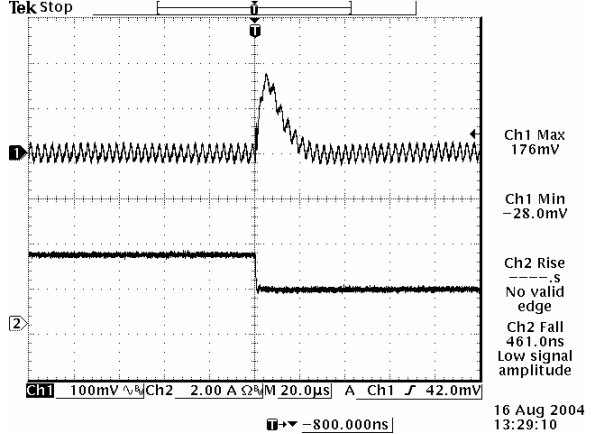
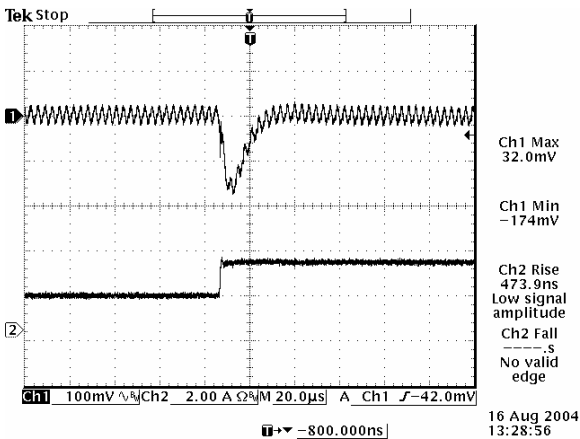

Transients 50% to 100% load 3.3 Vdc output

Transients 100% to 50% load 3.3 Vdc output

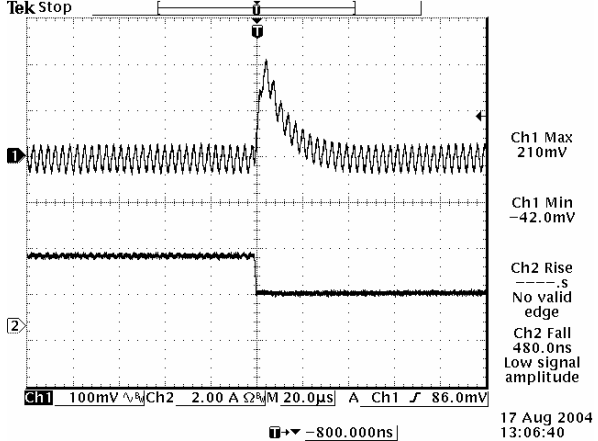
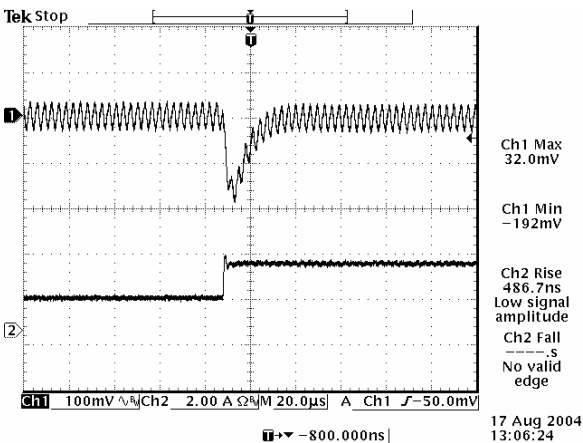

Transients 50% to 100% load 5.0 Vdc output

Transients 100% to 50% load 5.0 Vdc output

**Note:** Transient response at 12 Vdc input, di/dt=2.5 A/uS, with 10 uF/10 V tantalum cap and 1 uF/10 V ceramic cap at the output, Ta=25 deg C.

## NON-ISOLATED DC/DC CONVERTERS

8.3 Vdc - 14 Vdc Input

0.75 Vdc - 5.0 Vdc/3 A Output



### Mechanical Outline

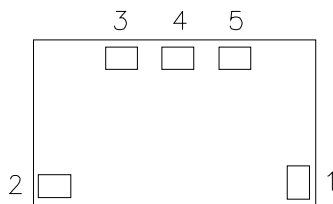
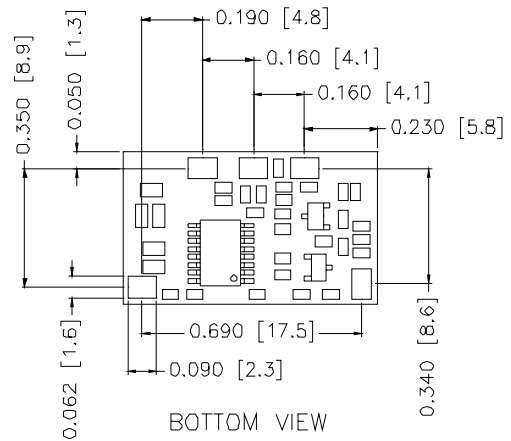
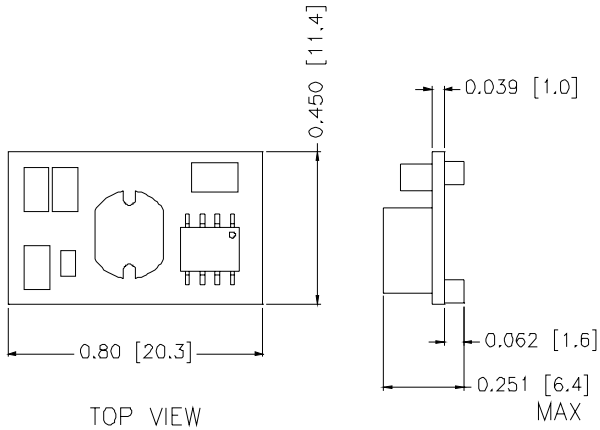

### Pin Connections

Pin	Function
1	Remote On/Off
2	Vin
3	Ground
4	Trim
5	Vout

### RECOMMENDED PAD LAYOUT

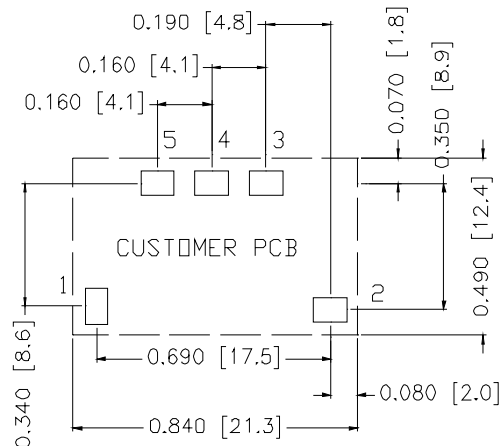

### PAD SIZE:

MIN: 0.12" \* 0.095" (3.05mm \* 2.41mm)

MAX: 0.135" \* 0.11" (3.43mm \* 2.79mm)

### RoHS Compliance

Complies with the European Directive 2002/95/EC, calling for the elimination of lead and other hazardous substances from electronic products.



#### CORPORATE

**Bel Fuse Inc.**  
 206 Van Vorst Street  
 Jersey City, NJ 07302  
 Tel 201-432-0463  
 Fax 201-432-9542  
[www.belfuse.com](http://www.belfuse.com)

#### FAR EAST

**Bel Fuse Ltd.**  
 8F/ 8 Luk Hop Street  
 San Po Kong  
 Kowloon, Hong Kong  
 Tel 852-2328-5515  
 Fax 852-2352-3706  
[www.belfuse.com](http://www.belfuse.com)

#### EUROPE

**Bel Fuse Europe Ltd.**  
 Preston Technology Management Centre  
 Marsh Lane, Suite G7, Preston  
 Lancashire, PR1 8UD, U.K.  
 Tel 44-1772-556601  
 Fax 44-1772-888366  
[www.belfuse.com](http://www.belfuse.com)