

Excellent Integrated System Limited

Stocking Distributor

Click to view price, real time Inventory, Delivery & Lifecycle Information:

[Samtec, Inc.](#)
[IPL1-102-02-S-D-K](#)

For any questions, you can email us directly:
sales@integrated-circuit.com

REVISION A

DO NOT SCALE FROM THIS PRINT

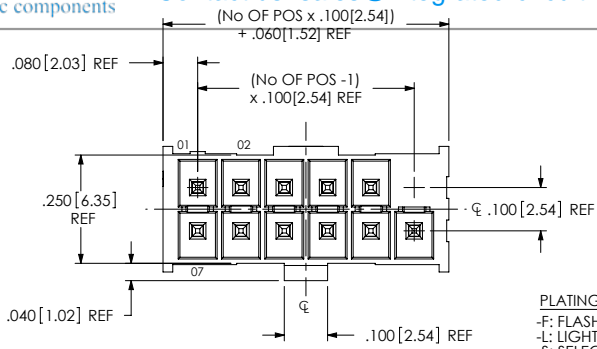
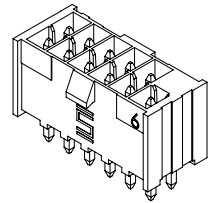
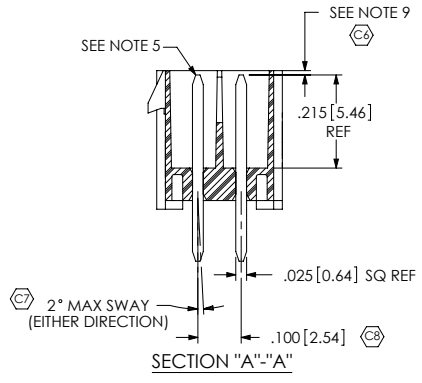
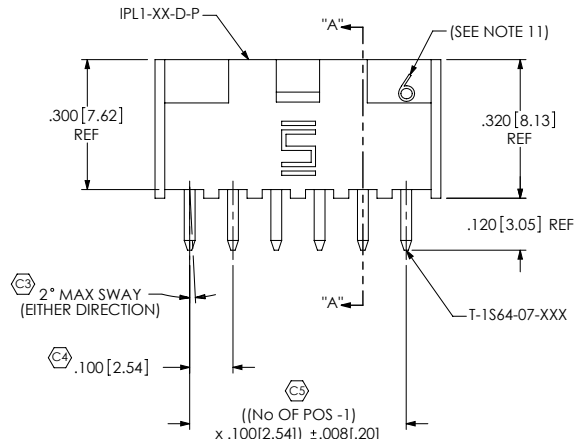

FIG 1
IPL1-106-01-XXX-D-P SHOWN

- IPL1-1XX-XX-XXX-D-XX-X**
- No OF POSITIONS -02 THRU .25 (PER ROW)
- LEAD STYLE**
-01: THROUGH HOLE (USE T-1S64-XX-XX)
-02: SURFACE MOUNT (SEE FIG 2, SHT 2) (USE T-1S64-XX-XX)
- PLATING SPECIFICATION**
-F: FLASH SELECTIVE (USE T-1S64-XX-F)
-L: LIGHT SELECTIVE (USE T-1S64-XX-L)
-S: SELECTIVE (USE T-1S64-XX-S)
-H: HEAVY GOLD (T-1S64-XX-H)
-FM: FLASH SELECTIVE/MATTE TIN TAILS (USE T-1S64-XX-F)
-LM: LIGHT SELECTIVE/MATTE TIN TAILS (USE T-1S64-XX-L)
-SM: SELECTIVE/MATTE TIN TAILS (USE T-1S64-XX-S)
-STL: SELECTIVE/TIN/LEAD TAILS (USE T-1S64-XX-STL)
- OPTION**
-P: POLARIZATION (SEE FIG 1) (USE IPL1-XX-D-P) (NOT AVAILABLE W/ -K OR -G, OPTIONS)
-K: KEYED POLARIZATION (USE IPL1-XX-D-K) (SEE FIG 5, SHEET 3) (NOT AVAILABLE W/ -P OR -G, OPTIONS)
-G: GUIDE POSTS (SEE FIG 6 & 7, SHEET 3) (USE IPL1-XX-D-GP) (NOT AVAILABLE W/-P, -K OPTIONS) (LEAVE BLANK FOR NO POLARIZATION (SEE FIG 4, SHEET 3). SAMTEC WILL ONLY SUPPORT EXISTING BUSINESS AS OF REV U)
- OPTION**
-RA: RIGHT ANGLE (SEE FIG 3, SHT 2) (AVAILABLE WITH -01 LEAD STYLE ONLY)
- ROW SPECIFICATION**
-D: DOUBLE (USE IPL1-XX-D)



- NOTES:
1. Ⓢ REPRESENTS A CRITICAL DIMENSION.
 2. NOTE DELETED.
 3. MINIMUM TERMINAL RETENTION: 1 LB.
 4. PARTS TO BE MOLDED TO POSITION.
 5. POST MUST BE WITHIN .005[.13] OF EACH OTHER.
 6. ALL PIN TO PIN DIMENSIONS TO BE MEASURED FROM TIP TO TIP.
 7. NOTE DELETED.
 8. DIMENSION TO BE MEASURED AT BEND.
 9. TIP TO BE FLUSH TO .015 BELOW TOP OF SHROUD.
 10. BOTH ROWS TO BE SYMMETRIC WITHIN .010[0.25].
 11. THIS NUMBER REPRESENTS THE NUMBER OF POSITIONS PER ROW ONLY AND IS NOT INTENDED TO BE USED IN POSITION NUMBERING.
 12. 1 OR 2 GATE PADS TO BE PRESENT AT VENDOR DISCRETION.

TABLE 1

LEAD STYLE	OPTION	TERMINAL 1	OAL REF	TERMINAL 2	OAL REF
-01	NONE	T-1S64-07-X	.430[10.92]	N/A	N/A
-01	-RA	T-1S64-09-X	.530[13.46]	T-1S64-10-X	.730[18.54]
-02	NONE	T-1S64-08-X	.445[11.30]	N/A	N/A

UNLESS OTHERWISE SPECIFIED, DIMENSIONS ARE IN INCHES. TOLERANCES ARE:
DECIMALS: .XX: ±.01[.3] .XXX: ±.005[.13] .XXXX: ±.0020[.051]
ANGLES: ± 2°

PROPRIETARY NOTE: THIS DOCUMENT CONTAINS INFORMATION CONFIDENTIAL AND PROPRIETARY TO SAMTEC, INC. AND SHALL NOT BE REPRODUCED OR TRANSFERRED TO OTHER DOCUMENTS OR DISCLOSED TO OTHERS OR USED FOR ANY PURPOSE OTHER THAN THAT WHICH IT WAS OBTAINED WITHOUT THE EXPRESSED WRITTEN CONSENT OF SAMTEC, INC.

MATERIAL: DO NOT SCALE DRAWING SHEET SCALE: 3:1
INSULATOR: LCP UL94-V0, COLOR: BLACK
-K INSULATOR: LCP UL94-V0, COLOR: NATURAL
TERMINAL: PHOS BRONZE

DESCRIPTION: .100[2.54] DOUBLE ROW TERMINAL ASSEMBLY

DWG. NO. **IPL1-1XX-XX-XXX-D-XX-X**

BY: KEVIN B 03/11/02 SHEET 1 OF 3

F:\DWG\MSC\MKTG\IPL1-1XX-XX-XXX-D-XX-X-MKT.SLDDRW

Samtec
520 PARK EAST BLVD, NEW ALBANY, IN 47150
PHONE: 812-944-6733 FAX: 812-948-5047
e-Mail: info@SAMTEC.com code 55322

REVISION A/F

FIG 2
IPL1-106-02-XXX-D-P SHOWN
[DIFFERENT AS SHOWN, OTHERWISE SAME AS FIG 1]

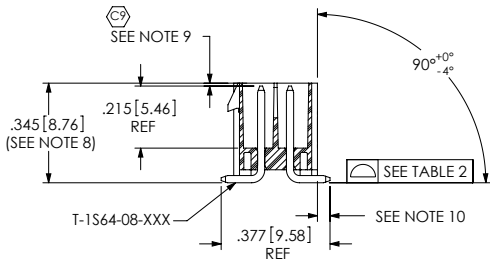

No OF POS.	COPLANARITY
-02 THRU -05	.004[.10]
-06 THRU -10	.005[.13]
-11 THRU -25	.006[.15]

-02: SURFACE MOUNT INPROCESS 1

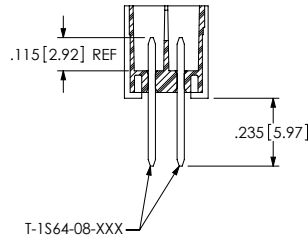

-02: SURFACE MOUNT INPROCESS 2

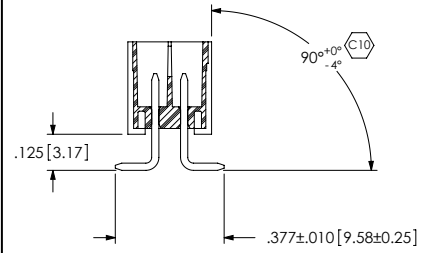

PACKAGING VIEWS
(ASSEMBLIES TO HAVE POSITION #1 LOADED IN THE SAME DIRECTION AS ARROW ON TUBE, EXCEPT WITH -RA OPTION)

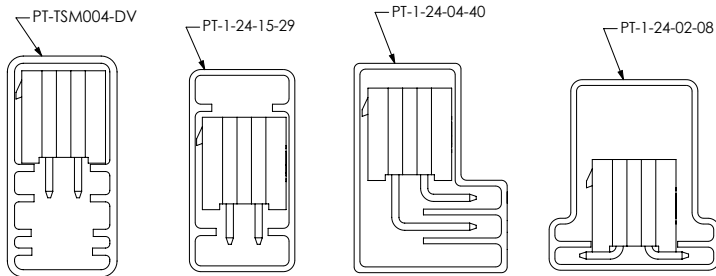

LEAD STYLE	OPTION	PACKAGING TUBE	PLUG
-01	NONE	PT-1-24-15-29	TP-07
-01 (2 POSITION)	NONE	PT-TSM004-DV	TP-07
-01	-RA	PT-1-24-04-40	TP-07
-02	NONE	PT-1-24-02-08	TP-13

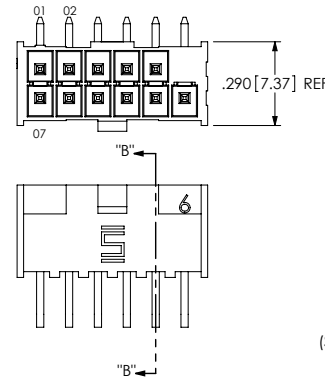
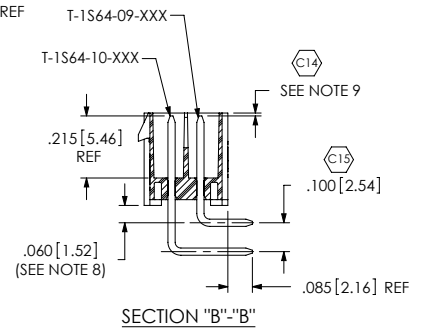

FIG 3
IPL1-106-01-XXX-D-RA-P SHOWN
(DIFFERENT AS SHOWN, OTHERWISE SAME AS FIG 1)



F:\DWG\MISC\MKTG\IPL1-100-XX-XXX-D-XX-X-MKT.SLDDRW

PROPRIETARY NOTE
THIS DOCUMENT CONTAINS INFORMATION CONFIDENTIAL AND PROPRIETARY TO SAMTEC, INC. AND SHALL NOT BE REPRODUCED OR TRANSFERRED TO OTHER DOCUMENTS OR DISCLOSED TO OTHERS OR USED FOR ANY PURPOSE OTHER THAN THAT WHICH IT WAS OBTAINED WITHOUT THE EXPRESSED WRITTEN CONSENT OF SAMTEC, INC.

DO NOT SCALE DRAWING

SHEET SCALE: 2:1

Samtec

520 PARK EAST BLVD, NEW ALBANY, IN 47150
PHONE: 812-944-6733 FAX: 812-948-5047
e-Mail info@SAMTEC.com code 55322

DESCRIPTION: .100[2.54] DOUBLE ROW TERMINAL ASSEMBLY

DWG. NO. IPL1-1XX-XX-XXX-D-XX-X

BY: KEVIN B 03/11/02 SHEET 2 OF 3

REVISION AF

-RA: INPROCESS 1

-RA: INPROCESS 2

-RA: INPROCESS 3

-RA: INPROCESS 4

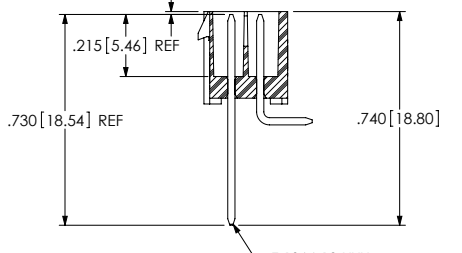
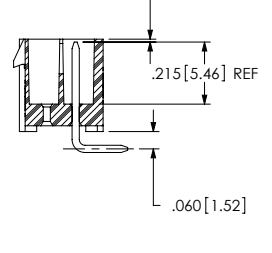
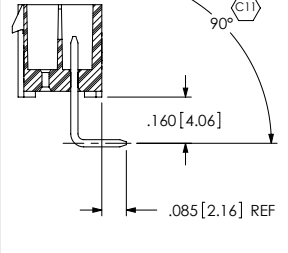
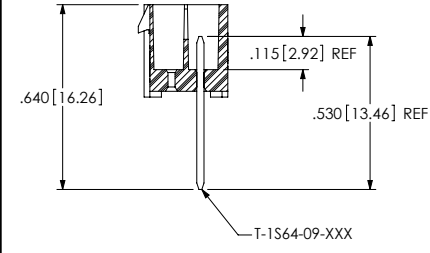

FIG 4
(IPL1-106-01-XXX-D SHOWN)
(DIFFERENT AS SHOWN,
OTHERWISE SAME AS FIG 1)

**SAMTEC WILL ONLY SUPPORT
EXISTING BUSINESS AS OF REV. U)**

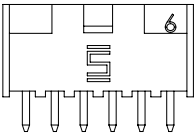
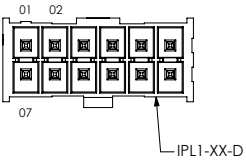

FIG 5
(IPL1-106-01-XXX-D-K SHOWN)
(DIFFERENT AS SHOWN, OTHERWISE SAME AS FIG 4)

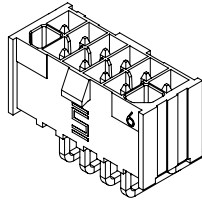
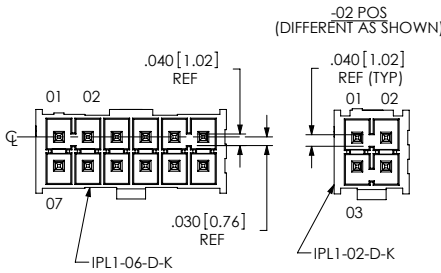

FIG 6
(IPL1-106-01-XXX-D-RA-G SHOWN)
(DIFFERENT AS SHOWN, OTHERWISE SAME AS FIG 3)

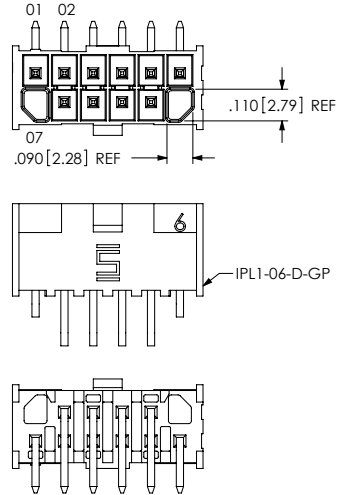
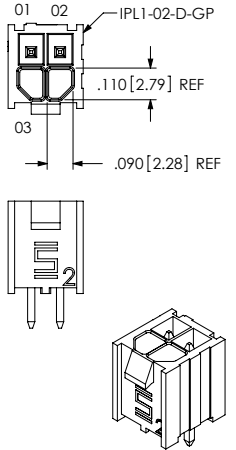

FIG 7
(IPL1-102-01-XXX-D-G SHOWN)
(DIFFERENT AS SHOWN,
OTHERWISE SAME AS FIG 1)



PROPRIETARY NOIE

THIS DOCUMENT CONTAINS INFORMATION
CONFIDENTIAL AND PROPRIETARY TO
SAMTEC, INC. AND SHALL NOT BE REPRODUCED
OR TRANSFERRED TO OTHER DOCUMENTS OR
DISCLOSED TO OTHERS OR USED FOR ANY
PURPOSE OTHER THAN THAT WHICH IT WAS
OBTAINED WITHOUT THE EXPRESSED WRITTEN
CONSENT OF SAMTEC, INC.

DO NOT SCALE DRAWING

SHEET SCALE: 2:1

samtec

520 PARK EAST BLVD, NEW ALBANY, IN 47150
PHONE: 812-944-6733 FAX: 812-948-5047
e-Mail info@SAMTEC.com code 55322

DESCRIPTION:
.100[2.54] DOUBLE ROW TERMINAL ASSEMBLY

DWG. NO.
IPL1-1XX-XX-XXX-D-XX-X

BY: KEVIN B 03/11/02 SHEET 3 OF 3