

## Excellent Integrated System Limited

Stocking Distributor

Click to view price, real time Inventory, Delivery & Lifecycle Information:

[Maxim Integrated](#)  
[MAX5547ETA+T](#)

For any questions, you can email us directly:

[sales@integrated-circuit.com](mailto:sales@integrated-circuit.com)



# Dual, 10-Bit, Current-Sink Output DAC

**MAX5547**

## General Description

The MAX5547 dual, 10-bit, dual range, digital-to-analog converter (DAC) sinks up to 3.6mA of current, making it ideal for laser-driver-control applications. Parallel the MAX5547 outputs to sink higher current (up to 7.2mA max). Operating from a single +2.7V to +5.25V supply, the MAX5547 typically consumes 1mA (internal reference).

The MAX5547 operates from a precision +2.5V internal 4ppm/°C reference or an external reference in the +2.45V to +2.55V range. The maximum full-scale current-sink range is software programmable to 3.6mA or 1.2mA for each DAC. A 10MHz SPI™-compatible serial interface configures the device.

The MAX5547 is available in a 3mm x 3mm x 0.8mm 8-pin TDFN package and is specified over the -40°C to +85°C extended temperature range.

## Applications

- Laser-Driver Control
- Pin-Diode Bias Currents
- Modulation Currents
- Average Power
- Extinction Ratios

## Features

- ◆ Dual Current-Sink DACs
- ◆ 10-Bit Resolution
- ◆ Two Software-Programmable Full-Scale Current Ranges: 3.6mA or 1.2mA
- ◆ Parallelable Outputs for Up to 7.2mA (max)
- ◆ +2.5V Internal Reference Drifts Only 4ppm/°C
- ◆ +2.7V to +5.25V Single-Supply Operation
- ◆ INL: ±1 LSB
- ◆ DNL: ±0.75 LSB (Guaranteed Monotonic)
- ◆ Low +0.8V Output Compliance
- ◆ Ultra-Small, 3mm x 3mm x 0.8mm, 8-Pin TDFN Package

## Ordering Information

PART	TEMP RANGE	PIN-PACKAGE	TOP MARK
MAX5547ETA+	-40°C to +85°C	8 TDFN-EP*	APF

\*EP = Exposed pad.

+ Denotes a lead(Pb)-free/RoHS-compliant package.

Pin Configuration appears at end of data sheet.

## Typical Operating Circuit

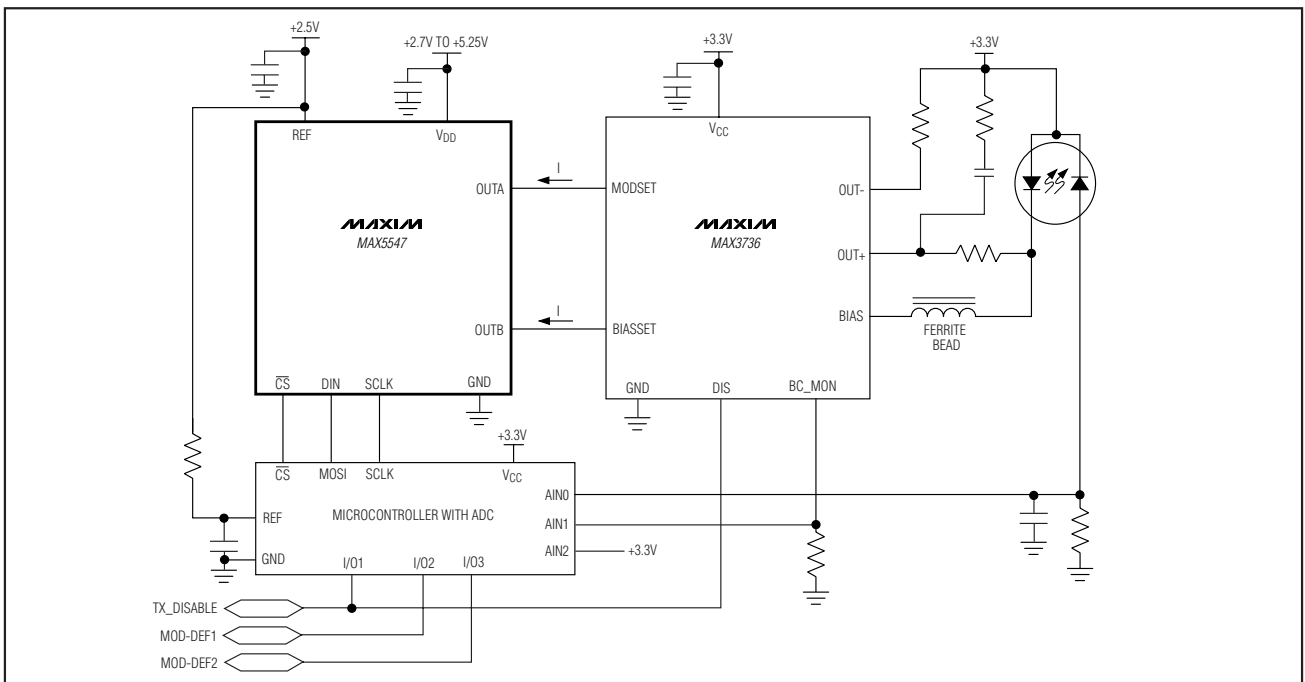

SPI is a trademark of Motorola, Inc.



# Dual, 10-Bit, Current-Sink Output DAC

## ABSOLUTE MAXIMUM RATINGS

V <sub>DD</sub> to GND	-0.3V to +6V	Operating Temperature Range	-40°C to +85°C
OUTA, OUTB, REF to GND	-0.3V to (V <sub>DD</sub> + 0.3V)	Junction Temperature	+150°C
SCLK, DIN, CS to GND	-0.3V to +6V	Storage Temperature Range	-65°C to +150°C
Continuous Power Dissipation (T <sub>A</sub> = +70°C)		Lead Temperature (soldering, 10s)	+300°C
8-Pin TDFN (derate 18.2mW/°C above +70°C)	1454.5mW		

Stresses beyond those listed under "Absolute Maximum Ratings" may cause permanent damage to the device. These are stress ratings only, and functional operation of the device at these or any other conditions beyond those indicated in the operational sections of the specifications is not implied. Exposure to absolute maximum rating conditions for extended periods may affect device reliability.

## ELECTRICAL CHARACTERISTICS

(V<sub>DD</sub> = +2.7V to +5.25V, V<sub>GND</sub> = 0V, external reference = +2.5V, output voltage = +2.0V, T<sub>A</sub> = -40°C to +85°C. Typical values are at V<sub>DD</sub> = +3.0V, and T<sub>A</sub> = +25°C.) (Note 1)

PARAMETER	SYMBOL	CONDITIONS	MIN	TYP	MAX	UNITS
<b>STATIC PERFORMANCE—ANALOG SECTION</b>						
Resolution			10			Bits
Integral Nonlinearity (Note 2)	INL	I <sub>OUT_</sub> = 1.2mA		±1	±6	LSB
		I <sub>OUT_</sub> = 3.6mA		±1	±6	
Differential Nonlinearity	DNL	Guaranteed monotonic			±0.75	LSB
Offset Error	OE	Code = 030h, T <sub>A</sub> = +25°C			±9	LSB
Offset Temperature Coefficient		(Note 3)		0.05	0.15	LSB/°C
Gain Error	GE	Measured from code 030h to 3FFh	I <sub>OUT_</sub> = 1.2mA	±0.1	±3	%
			I <sub>OUT_</sub> = 3.6mA	±0.1	±5.5	
Gain Temperature Coefficient		I <sub>OUT_</sub> = 1.2mA		15		ppm/°C
		I <sub>OUT_</sub> = 3.6mA		25		
Line Regulation		V <sub>DD</sub> = +2.7V to +5.25V			0.8	LSB/V
Output Crosstalk		OUTA = midscale, OUTB switching from 030h to 3FFh		54		dB
<b>REFERENCE</b>						
Internal-Reference Voltage	V <sub>REF</sub>	T <sub>A</sub> = +25°C	2.48	2.5	2.52	V
Internal-Reference Temperature Coefficient		(Note 4)		4	30	ppm/°C
Internal-Reference Load Regulation		0μA < I <sub>REF</sub> < +300μA		1	3.5	Ω
Internal-Reference Power-Up Time		C <sub>REF</sub> = 1μF, to 0.05%		0.55		ms
Internal-Reference Sink Current					50	μA
Internal-Reference Source Current					300	μA
REF Capacitive Load		(Note 4)	0.1		10.0	μF
Reference Line Regulation		V <sub>DD</sub> = +2.7V to +5.25V		25		μV/V
Internal-Reference Noise		f = 0.1Hz to 10Hz		10		μV <sub>RMS</sub>
		f = 10Hz to 10kHz		27		
External-Reference Range	V <sub>REF</sub>		2.45		2.55	V

## Dual, 10-Bit, Current-Sink Output DAC

### ELECTRICAL CHARACTERISTICS (continued)

(V<sub>DD</sub> = +2.7V to +5.25V, V<sub>GND</sub> = 0V, external reference = +2.5V, output voltage = +2.0V, T<sub>A</sub> = -40°C to +85°C. Typical values are at V<sub>DD</sub> = +3.0V, and T<sub>A</sub> = +25°C.) (Note 1)

PARAMETER	SYMBOL	CONDITIONS	MIN	TYP	MAX	UNITS	
External-Reference Input Impedance	R <sub>REF</sub>			90		kΩ	
<b>DAC OUTPUTS</b>							
Output Current (Note 5)	I <sub>OUT-</sub>	1.2mA low-current range	Code = 030h	50		μA	
			Code = 3FFh	1170	1200		1230
		3.6mA high-current range	Code = 030h	150			
			Code = 3FFh	3400	3600		3800
LSB Size		1.2mA full-scale current		1.17		μA	
		3.6mA full-scale current		3.52			
Current-Source Compliance Voltage Range		I <sub>OUT-</sub> = full-scale (Note 6)	0.8			V	
Output Impedance at Full-Scale Current		I <sub>OUT-</sub> = 1.2mA, V <sub>OUT</sub> = +1V to +5.25V		600		kΩ	
		I <sub>OUT-</sub> = 3.6mA, V <sub>OUT</sub> = +1V to +5.25V		180			
<b>DYNAMIC PERFORMANCE</b>							
Settling Time	t <sub>S</sub>	To 1% (Note 7)		10		μs	
Output Noise	I <sub>RMS</sub>	f = 0.1Hz to 10Hz		0.05		LSB <sub>RMS</sub>	
		f = 10Hz to 10kHz		0.35			
Supply Feedthrough		100mV, 1kHz signal added to V <sub>DD</sub>		0.85		LSB/V	
Digital Feedthrough		R <sub>LOAD</sub> = 500Ω, C <sub>LOAD</sub> = 100pF		2		pA•s	
Digital-to-Analog Glitch Impulse		R <sub>LOAD</sub> = 500Ω, C <sub>LOAD</sub> = 100pF		16		pA•s	
DAC-to-DAC Full-Scale Current Matching				2		%	
<b>POWER SUPPLIES</b>							
Supply Voltage	V <sub>DD</sub>		+2.70		+5.25	V	
Supply Current	I <sub>DD</sub>	V <sub>DD</sub> = +5.25V, no load, SCLK not switching	Internal reference mode	1.1	2	mA	
			External reference mode	0.75	1.5		
<b>LOGIC AND CONTROL INPUTS</b>							
Input High Voltage	V <sub>IH</sub>	(Note 8)	0.7 x V <sub>DD</sub>			V	
Input Low Voltage	V <sub>IL</sub>	(Note 8)			0.8	V	
Input Hysteresis	V <sub>HYS</sub>		0.05 x V <sub>DD</sub>			V	
Input Capacitance	C <sub>IN</sub>			10		pF	
Input Leakage Current	I <sub>IN</sub>				±1	μA	

## Dual, 10-Bit, Current-Sink Output DAC

### ELECTRICAL CHARACTERISTICS (continued)

( $V_{DD} = +2.7V$  to  $+5.25V$ ,  $V_{GND} = 0V$ , external reference =  $+2.5V$ , output voltage =  $+2.0V$ ,  $T_A = -40^\circ C$  to  $+85^\circ C$ . Typical values are at  $V_{DD} = +3.0V$ , and  $T_A = +25^\circ C$ .) (Note 1)

PARAMETER	SYMBOL	CONDITIONS	MIN	TYP	MAX	UNITS
<b>SPI TIMING CHARACTERISTICS (see Figure 1)</b>						
SCLK Clock Period	$t_{CP}$		100			ns
SCLK Pulse-Width High	$t_{CH}$		40			ns
SCLK Pulse-Width Low	$t_{CL}$		40			ns
$\overline{CS}$ Fall to SCLK Fall Setup Time	$t_{CSS}$		25			ns
SCLK Fall to $\overline{CS}$ Rise Hold Time	$t_{CSH}$		50			ns
DIN to SCLK Fall Setup Time	$t_{DS}$		40			ns
DIN to SCLK Fall Hold Time	$t_{DH}$		0			ns
$\overline{CS}$ Pulse-Width High	$t_{CSW}$		100			ns

**Note 1:** Devices are 100% production tested at  $T_A = +25^\circ C$ . Limits over temperature are guaranteed by design.

**Note 2:** INL linearity is from code 48 to code 1023.

**Note 3:** Specification based on characterization data. Not production tested.

**Note 4:** Guaranteed by design. Not production tested.

**Note 5:** The DACs continue to operate at currents lower than  $50\mu A$  on the  $1.2mA$  range and  $150\mu A$  on the  $3.6mA$  range. However, performance is not guaranteed at these low currents. A code of all zeros has a nominal output current of  $0\mu A$ .

**Note 6:** Compliance voltage range is defined as the range where the output current is  $-2$  LSB of its value at  $V_{OUT} = +1V$ .

**Note 7:** Settling time is measured from  $0.25 \times$  full scale to  $0.75 \times$  full scale.

**Note 8:** The device draws higher supply current when the digital inputs are driven with voltages between ( $V_{DD} - 0.5V$ ) and ( $V_{GND} + 0.5V$ ). See Supply Current vs. Digital Input Voltage in the *Typical Operating Characteristics*.

### Typical Operating Characteristics

( $V_{DD} = +3.0V$ ,  $V_{GND} = 0V$ , external reference =  $+2.5V$ ,  $T_A = +25^\circ C$ , unless otherwise noted.)

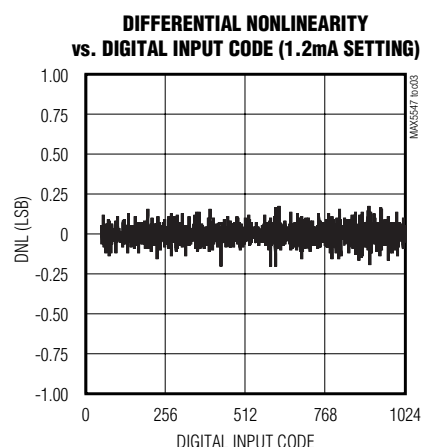
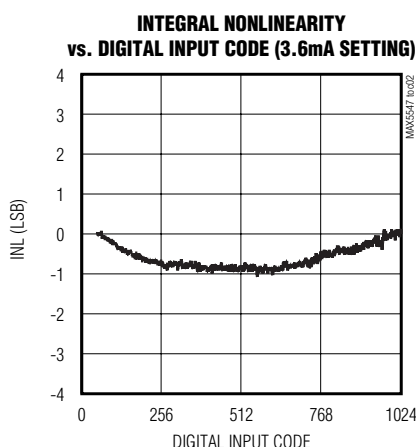
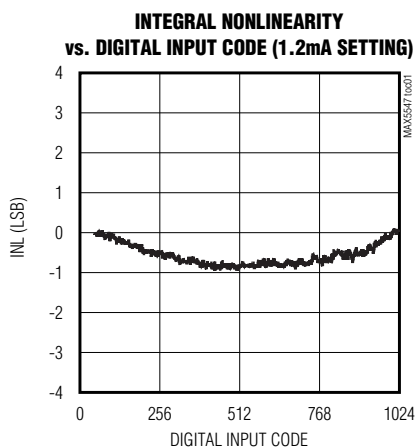

## Dual, 10-Bit, Current-Sink Output DAC

### Typical Operating Characteristics (continued)

( $V_{DD} = +3.0V$ ,  $V_{GND} = 0V$ , external reference = +2.5V,  $T_A = +25^\circ C$ , unless otherwise noted.)

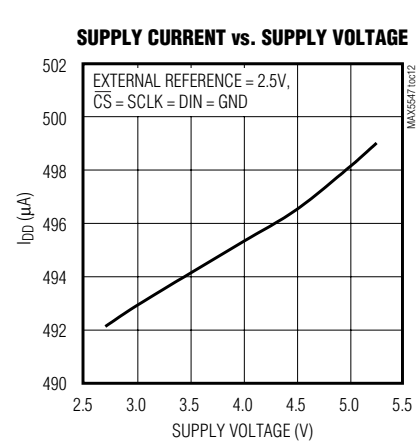
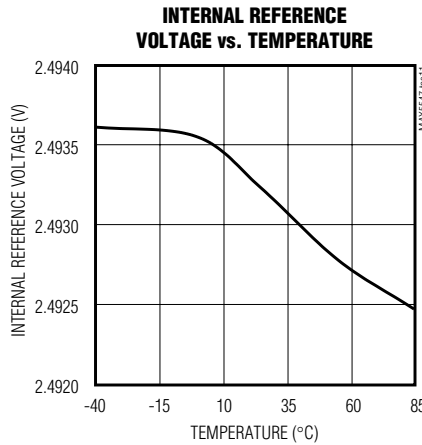
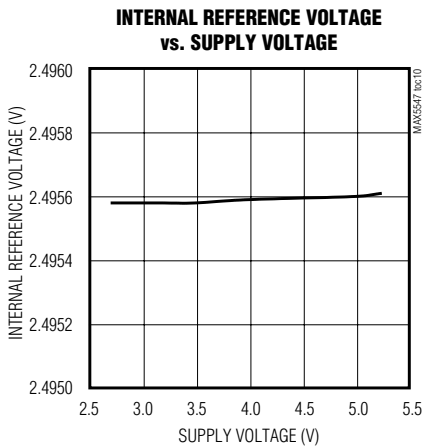
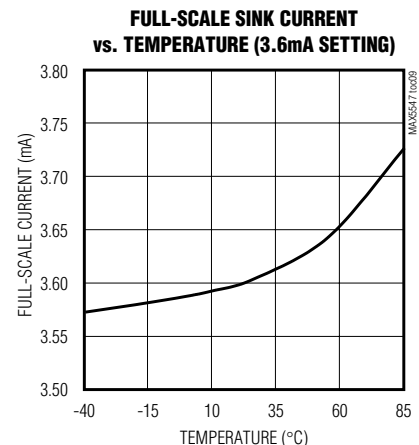
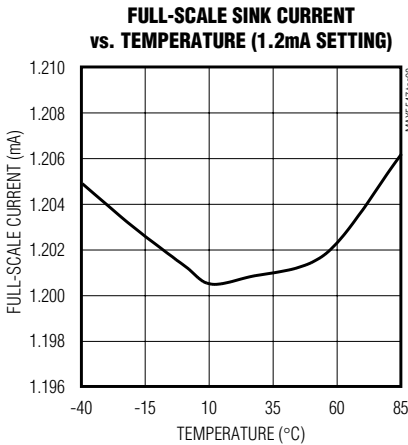
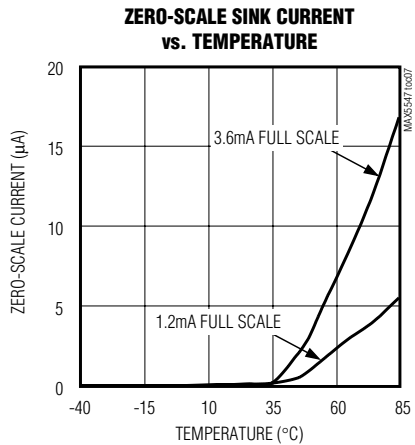
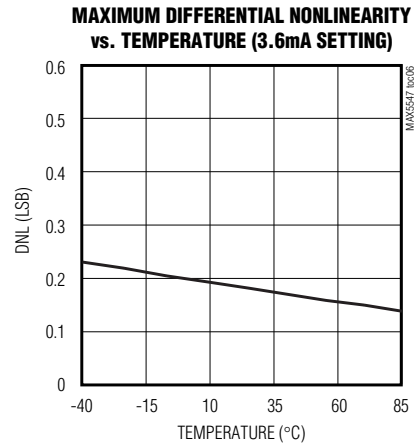
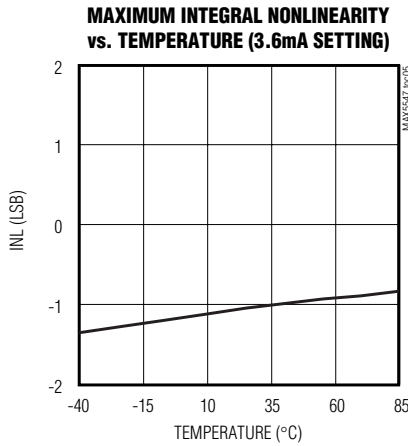
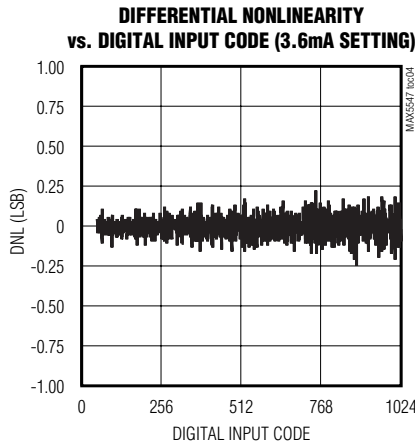

# Dual, 10-Bit, Current-Sink Output DAC

## Typical Operating Characteristics (continued)

( $V_{DD} = +3.0V$ ,  $V_{GND} = 0V$ , external reference = +2.5V,  $T_A = +25^\circ C$ , unless otherwise noted.)

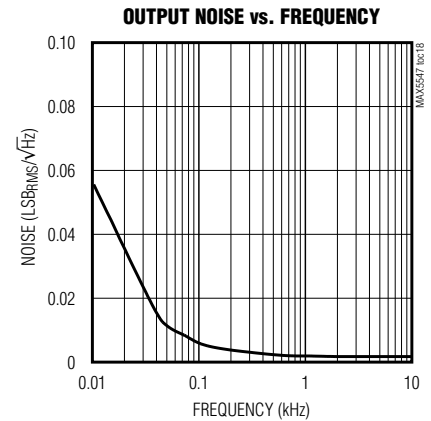
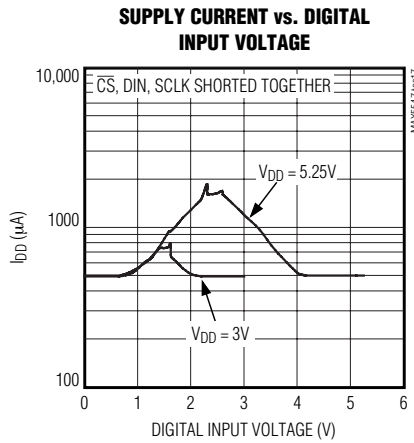
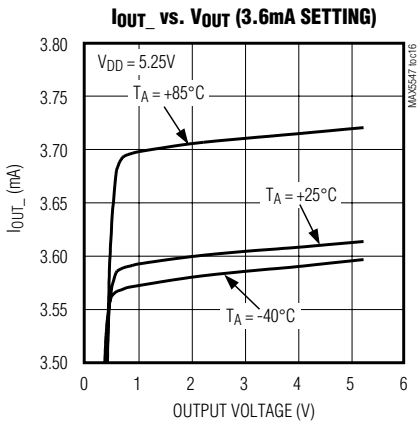
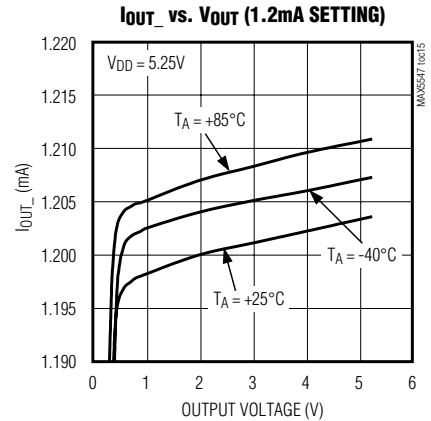
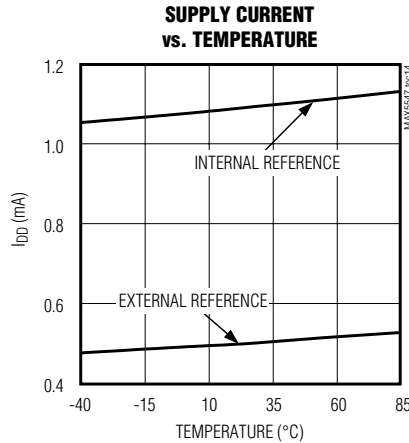
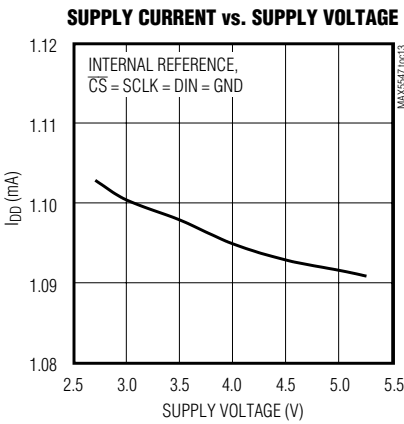

**SETTLING TIME (FULL-SCALE POSITIVE STEP) (I<sub>OUT-</sub> = 1.2mA)**

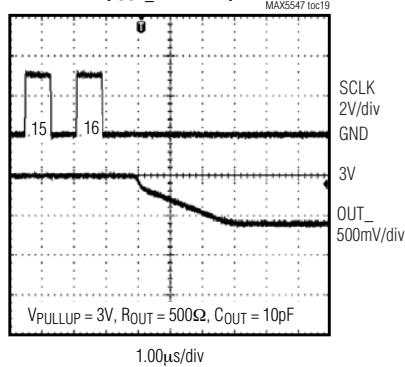

**SETTLING TIME (FULL-SCALE POSITIVE STEP) (I<sub>OUT-</sub> = 3.6mA)**

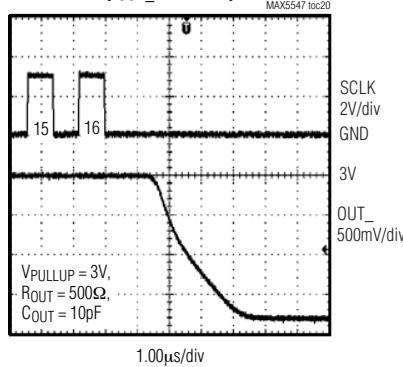

**SETTLING TIME (FULL-SCALE NEGATIVE STEP) (I<sub>OUT-</sub> = 1.2mA)**

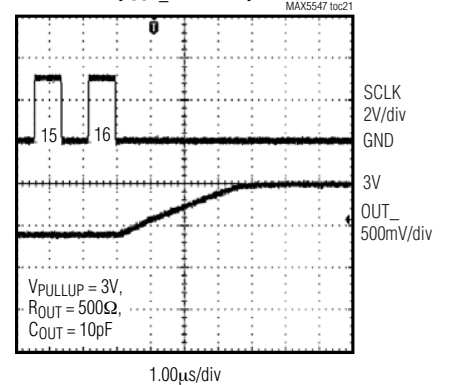

# Dual, 10-Bit, Current-Sink Output DAC

**MAX5547**

## Typical Operating Characteristics (continued)

( $V_{DD} = +3.0V$ ,  $V_{GND} = 0V$ , external reference =  $+2.5V$ ,  $T_A = +25^\circ C$ , unless otherwise noted.)

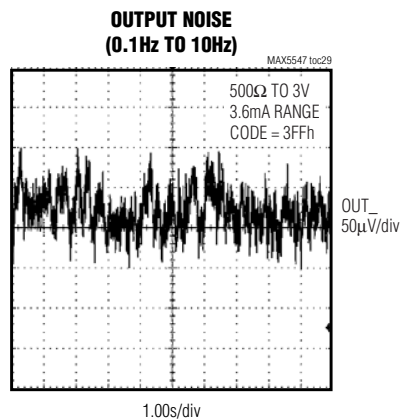
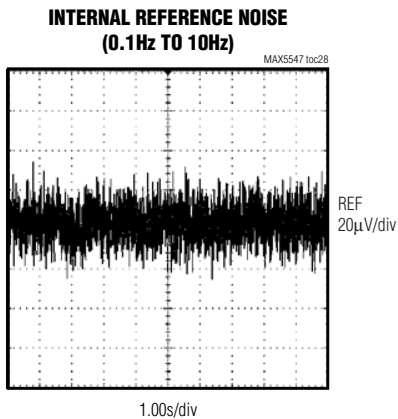
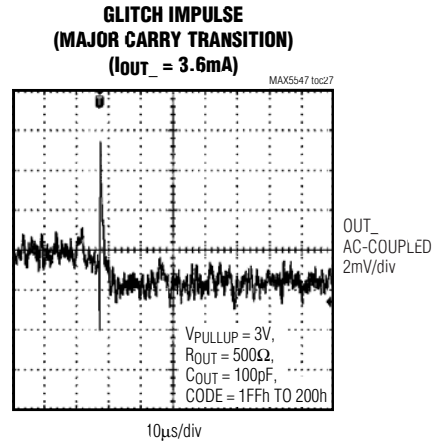
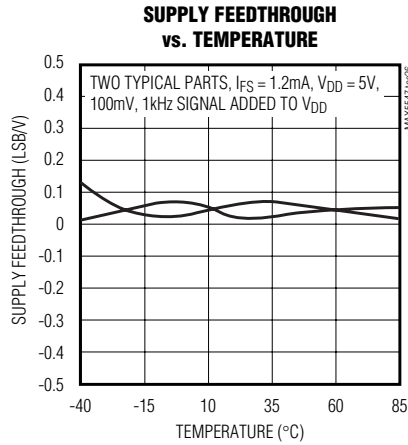
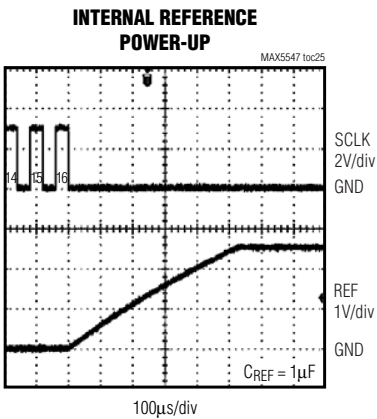
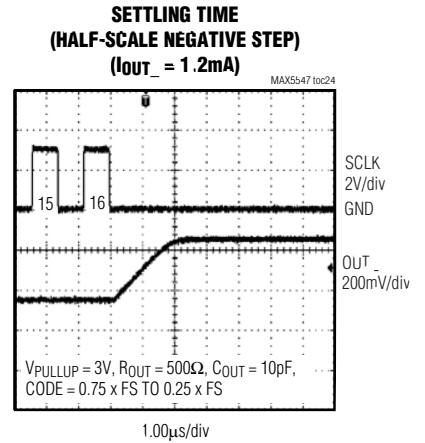
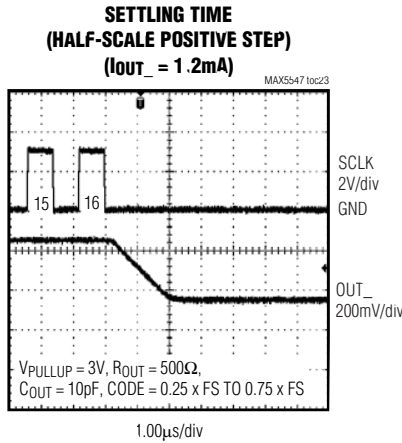
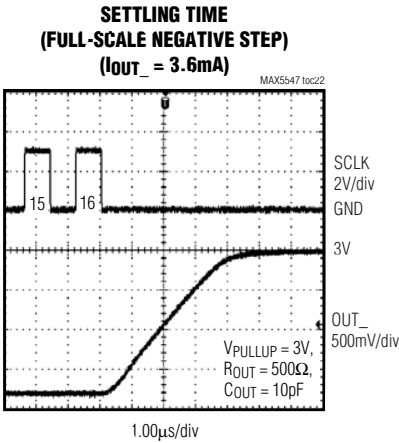



## Dual, 10-Bit, Current-Sink Output DAC

### Pin Description

PIN	NAME	FUNCTION
1	V <sub>DD</sub>	Supply Voltage. Set V <sub>DD</sub> between +2.7V to +5.25V. Bypass V <sub>DD</sub> with a 0.1μF capacitor to GND, as close to the device as possible.
2	$\overline{\text{CS}}$	Active-Low Chip-Select Input. Set $\overline{\text{CS}}$ low to enable the serial interface.
3	SCLK	Serial-Clock Input
4	DIN	Serial-Data Input. DIN is clocked into the serial interface on the falling edge of SCLK.
5	GND	Ground
6	REF	External Reference Input/Internal Reference Output. When programmed for internal reference mode, REF is a +2.5V output. When programmed for external reference mode, apply a voltage between +2.45V and +2.55V (see Table 1). Connect a 1μF ceramic capacitor from REF to GND, as close to the device as possible.
7	OUTB	DAC B Current Output. OUTB sinks up to 3.6mA.
8	OUTA	DAC A Current Output. OUTA sinks up to 3.6mA.
—	EP	Exposed Pad. Connect to GND. Do not use as the ground connection.

### Detailed Description

The MAX5547 10-bit, dual-range, current-sink DAC operates with serial data clock rates up to 10MHz. The double-buffered DAC input consists of a 16-bit input register and two 10-bit DAC registers, followed by a current-steering array (see the *Functional Diagram*). The MAX5547 sinks full-scale output currents of 1.2mA or 3.6mA per DAC. Each DAC's full-scale current can be independently programmed.

Operating from a single +2.7V to +5.25V supply, the MAX5547 typically consumes 1mA. The MAX5547 operates from an internal +2.5V reference or an external reference in the +2.45V to +2.55V range.

The MAX5547 is ideal as the digital/analog interface for laser-diode drivers with current-controlled inputs, such as the MAX3736 (see the *Typical Operating Circuit*). Set the current levels at the MAX3736's MODSET and BIASSET current-controlled inputs from the MAX5547's DAC outputs. The MAX3736's MODSET and BIASSET lines set the laser driver's desired modulation and bias currents.

#### Reference Architecture and Operation

The MAX5547 operates from an internal +2.5V reference or accepts an external reference voltage source between +2.45V and +2.55V. The internal reference is capable of sinking up to 50μA and sourcing up to 300μA. REF serves as the input for a low-impedance

reference source in external reference mode. Bypass REF to GND with a ceramic capacitor in the 0.1μF to 10μF range, as close to the device as possible, in both internal and external reference modes.

During startup, when power is first applied, the MAX5547 defaults to external reference mode, and to the 1.2mA full-scale current-range mode. Use software commands to select internal reference mode and 3.6mA full-scale current-range mode (see Table 1).

#### DAC Data

The MAX5547's internal registers set the DAC full-scale output currents (I<sub>FS</sub>) to 1.2mA or 3.6mA (see Table 1). The 10-bit DAC data is decoded as straight binary, with 1 LSB = I<sub>FS</sub> / 1023, and converted into the corresponding current as shown in Table 2.

#### Serial Interface

The MAX5547 operates through a 3-wire, 10MHz SPI-compatible serial interface.  $\overline{\text{CS}}$ , SCLK, and DIN control the serial interface timing and data. Ensure the SPI bus master, typically a microcontroller (μC), runs in master mode so that it generates the serial clock signal. Select an SCLK frequency of 10MHz or less and set the clock polarity (CPOL) and phase (CPHA) in the μC control registers to opposite values. The MAX5547 operates with SCLK idling high or low. Therefore, set CPOL = 0 and CPHA = 1, or CPOL = 1 and CPHA = 0.

## Dual, 10-Bit, Current-Sink Output DAC

**MAX5547**

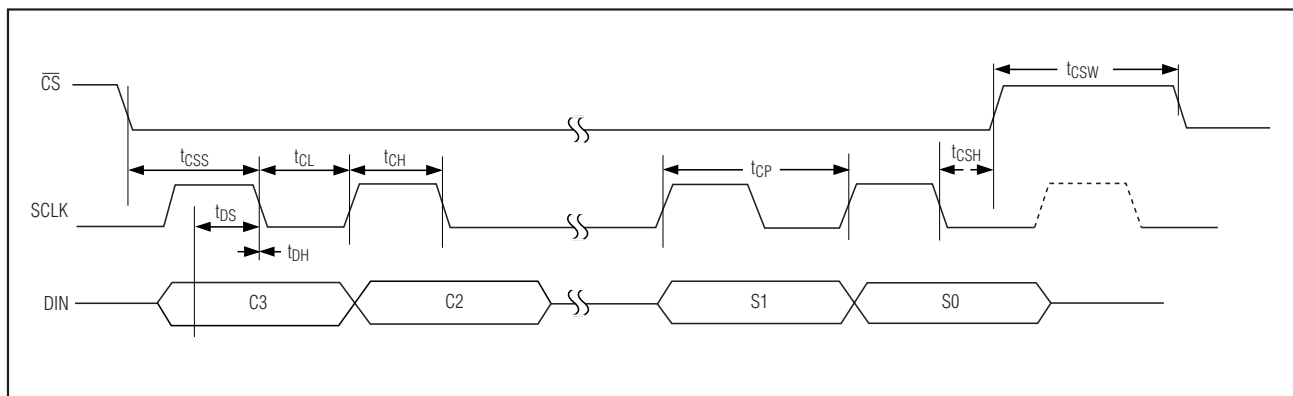

Figure 1. SPI Serial-Interface Timing Diagram

Set  $\overline{CS}$  low to begin clocking input data at DIN on the falling edge of SCLK (see Figure 1). Serial communications to the shift register consist of a 16-bit command word loaded from DIN. The first four control bits (C3–C0) determine the target register (see Table 1). The next 10 data bits set the current-sink level. D9 is the MSB and D0 the LSB. Set bits S1 and S0 to zero for proper operation. Data is latched into the appropriate DAC register on the 16th SCLK falling edge. After writing 16 bits, drive  $\overline{CS}$  high. Keep  $\overline{CS}$  low throughout the entire 16-bit word.

Write the command word to configure DAC registers A and B individually or both registers at the same time. The command word also determines whether the DACs use the internal or external reference.

The MAX5547 powers up in external reference mode with DAC registers A and B set to  $I_{FS} = 1.2\text{mA}$  at code 000h.

### Applications Information

#### Power Sequencing

Ensure the voltages applied at REF, OUTA, and OUTB do not exceed  $V_{DD}$  at any time. If proper power sequencing is not possible, connect an external Schottky diode between REF/OUTA/OUTB and  $V_{DD}$  to ensure compliance with the absolute maximum ratings.

#### Power-Supply Bypassing and Ground Management

Digital or AC transient signals on GND create noise at the analog output. Return GND to the highest quality ground plane available. For extremely noisy environments, bypass both REF and  $V_{DD}$  to GND with  $10\mu\text{F}$  and  $0.1\mu\text{F}$  capacitors in parallel, with the  $0.1\mu\text{F}$  capacitor as close to the device as possible. Careful PC board ground layout minimizes crosstalk between the DAC outputs and digital inputs.

## Dual, 10-Bit, Current-Sink Output DAC

Table 1. Command Word Summary

CONTROL BITS				MSB		DATA BITS								LSB		REGISTER FUNCTION
C3	C2	C1	C0	D9	D8	D7	D6	D5	D4	D3	D2	D1	D0	S1	S0	
0	0	0	0	X	X	X	X	X	X	X	X	X	X	0	0	External reference mode (default state). Connect an external voltage source at REF from +2.45V to +2.55V.
1	0	0	0	X	X	X	X	X	X	X	X	X	X	0	0	Internal reference mode. Internal reference is +2.5V.
0	0	1	0	10-bit data								0	0	Load DAC register A and set I <sub>OUTA</sub> full-scale range to 1.2mA.		
0	0	1	1	10-bit data								0	0	Load DAC register A and set I <sub>OUTA</sub> full-scale range to 3.6mA.		
0	1	0	0	10-bit data								0	0	Load DAC register B and set I <sub>OUTB</sub> full-scale range to 1.2mA.		
0	1	0	1	10-bit data								0	0	Load DAC register B and set I <sub>OUTB</sub> full-scale range to 3.6mA.		
0	1	1	0	10-bit data								0	0	Load DAC registers A and B and set I <sub>OUTA</sub> and I <sub>OUTB</sub> full-scale ranges to 1.2mA (default state).		
0	1	1	1	10-bit data								0	0	Load DAC registers A and B and set I <sub>OUTA</sub> and I <sub>OUTB</sub> ranges to 3.6mA.		

X = Don't care. Unused codes are reserved for factory use.

Table 2. Ideal DAC Output Code Table

BINARY DAC CODE	I <sub>OUT_</sub>
11 1111 1111	$1023 \times \frac{I_{FS}}{1023}$
10 0000 0000	$512 \times \frac{I_{FS}}{1023}$
00 0000 0001	$\frac{I_{FS}}{1023}$
00 0000 0000	0

### Pin Configuration

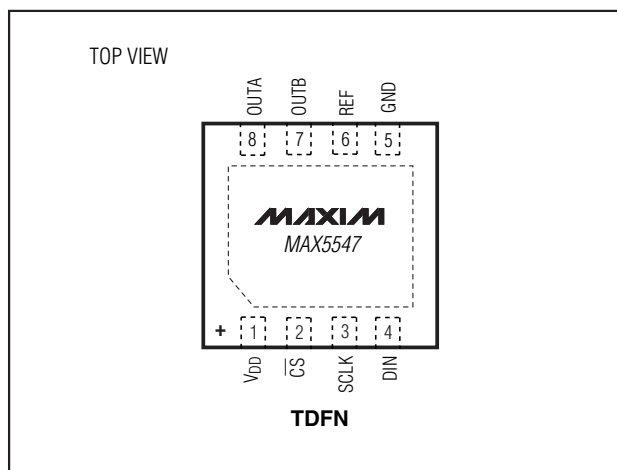

# Dual, 10-Bit, Current-Sink Output DAC

## Functional Diagram

**MAX5547**

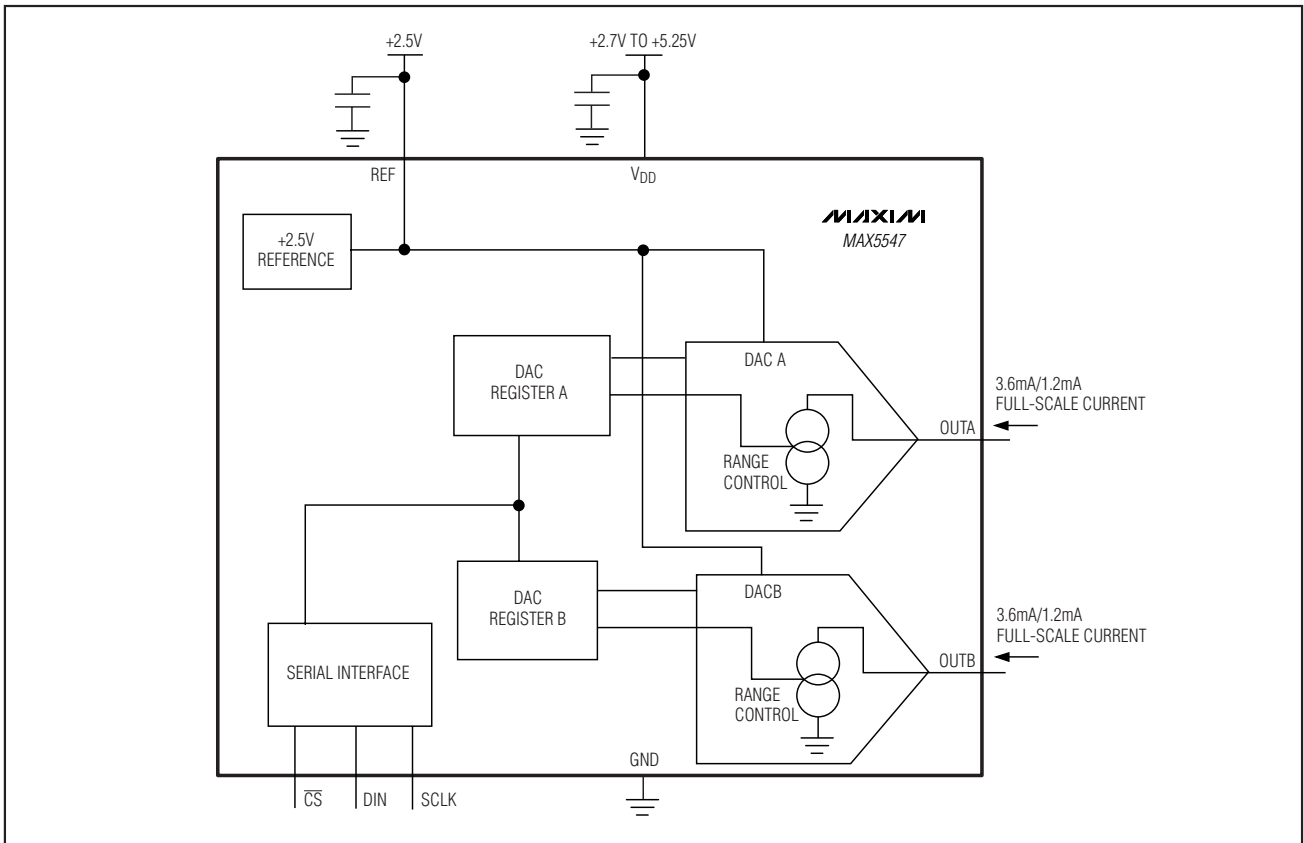

### Chip Information

PROCESS: BiCMOS

### Package Information

For the latest package outline information and land patterns, go to [www.maxim-ic.com/packages](http://www.maxim-ic.com/packages). Note that a "+", "#", or "-" in the package code indicates RoHS status only. Package drawings may show a different suffix character, but the drawing pertains to the package regardless of RoHS status.

PACKAGE TYPE	PACKAGE CODE	DOCUMENT NO.
8 TDFN-EP	T833+2	<a href="#">21-0137</a>

# Dual, 10-Bit, Current-Sink Output DAC

## Revision History

REVISION NUMBER	REVISION DATE	DESCRIPTION	PAGES CHANGED
2	7/09	Updated <i>Electrical Characteristics</i> table. Added lead-free note to <i>Ordering Information</i> . Updated I <sub>OUT_</sub> and linearity information.	1-5

Maxim cannot assume responsibility for use of any circuitry other than circuitry entirely embodied in a Maxim product. No circuit patent licenses are implied. Maxim reserves the right to change the circuitry and specifications without notice at any time.

12 **Maxim Integrated Products, 120 San Gabriel Drive, Sunnyvale, CA 94086 408-737-7600**