

Excellent Integrated System Limited

Stocking Distributor

Click to view price, real time Inventory, Delivery & Lifecycle Information:

[E-Switch](#)
[500SSP2S4M1QEB](#)

For any questions, you can email us directly:

sales@integrated-circuit.com

SHEET 1 OF 1

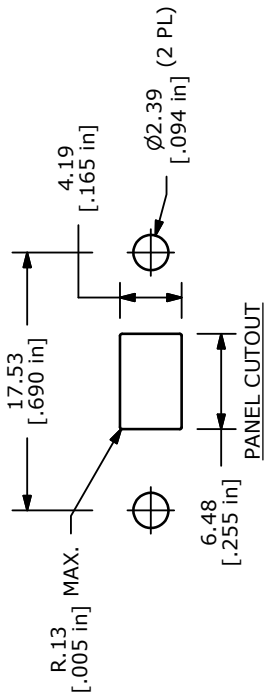

SWITCH FUNCTION	POS. 1	POS. 2	POS. 3
ON			
2-1	NONE	N/A	2-3

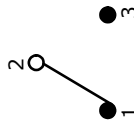

CIRCUIT: SPDT

- NOTE:
1. ALL DIMENSIONS IN MM [INCH]
 2. GENERAL TOLERANCE: X.X=±0.4
X.XX=±0.25
 3. TERMINAL NUMBERS FOR REF ONLY
 4. PLATING MATERIAL: SILVER
 5. CONTACT RATING: 5A @120VAC OR 28VDC, 2A @250VAC
 6. ELECTRIC LIFE: 30,000 ACTUATIONS AT FULL LOAD.
 7. INSULATION RESISTANCE: 1,000 MEGA-OHM MIN.
 8. DIELECTRIC STRENGTH: 1,000 V RMS @SEA LEVEL.
 9. OPERATING TEMP.: -30°C to 85°C
 10. ▲ DENOTES CRITICAL PARAMETER.
 11. CONTACT RESISTANCE: 10m OHM MAX INITIAL @ 2-4VDC
 12. 2002/95/EC (ROHS) COMPLIANT.

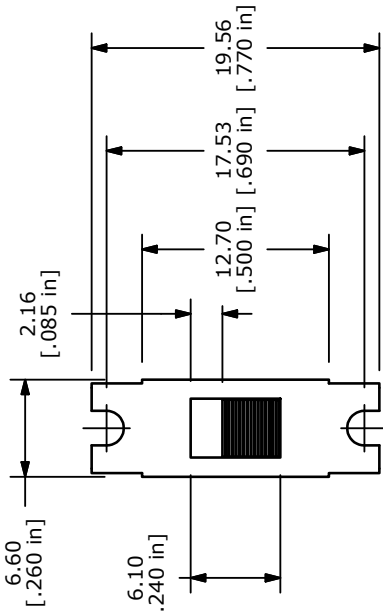

ISOMETRIC

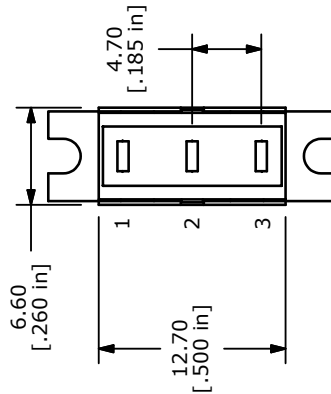
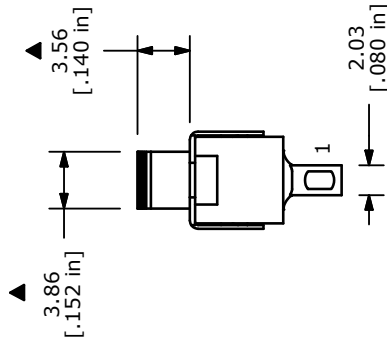
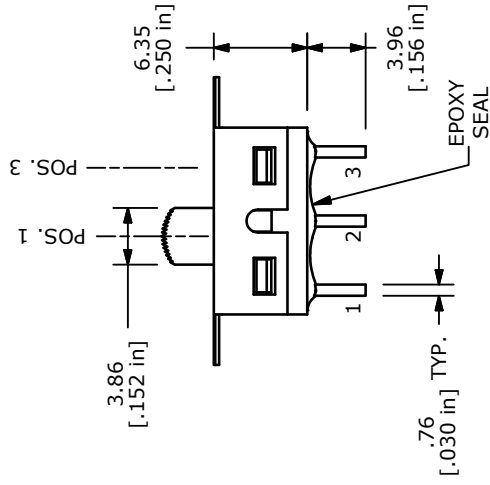
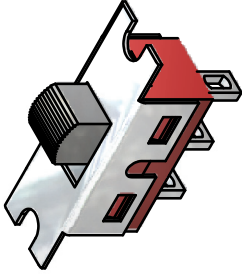

TITLE 500SSP2S4M1QEB

C	19560	DRAWING UPDATE	1/5/11	BGL
REV	PCR NO	DESCRIPTION	DATE	BY

THE INFORMATION CONTAINED IN THIS DOCUMENT IS PROPRIETARY TO E-SWITCH AND IS NOT TO BE COPIED OR TRANSFERRED

SCALE 2:1

DATE 1/5/2011

DR BGL

DWG T524000

REV C