

Excellent Integrated System Limited

Stocking Distributor

Click to view price, real time Inventory, Delivery & Lifecycle Information:

[E-Switch](#)
[R1966CBLKBLKEP](#)

For any questions, you can email us directly:

sales@integrated-circuit.com

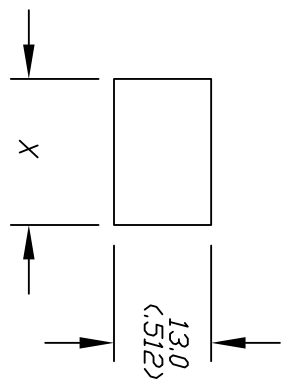
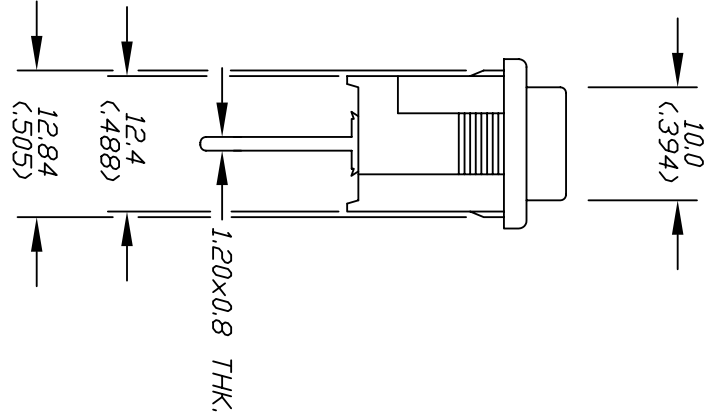
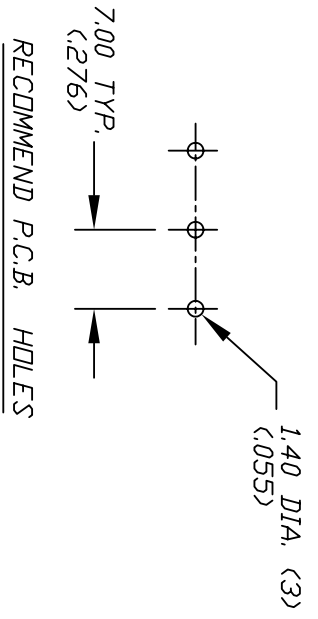
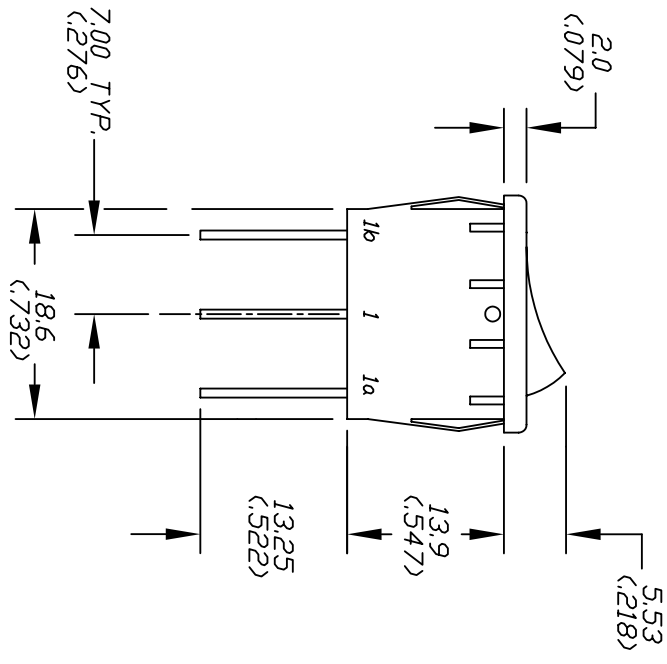
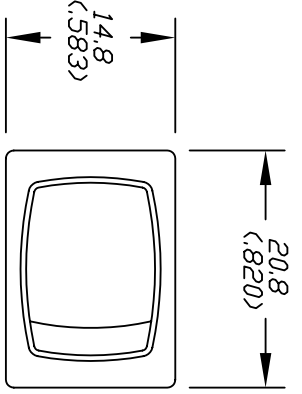

RECOMMEND PANEL MOUNTING

PANEL THICKNESS	X
0.75-1.25 (.030-.049)	19.2 (.756)
1.25-2.0 (.049-.079)	19.4 (.764)
2.0-3.0 (.079-.118)	19.6 (.772)

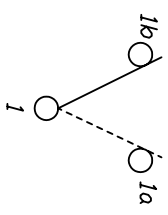

CIRCUIT: SPDT

CONTACT CONFIGURATION

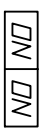

NOTES:

1. ALL DIMENSIONS IN MM (INCHES)
2. TERM. NOS. FOR REF ONLY
3. RATING: 15A 125V, 6A 250VAC

REV.	DESCRIPTION	DATE	CHKD
A	RELEASED FOR PRODUCTION		

THE INFORMATION CONTAINED IN THIS DOCUMENT IS PROPRIETARY TO E-SWITCH AND IS NOT TO BE COPIED OR TRANSFERRED

TOLERANCES	
0.0	±0.4
0.00	±0.25

SCALE	DATE	DR	DWG	REV
1.5:1	2/26/97	MM	M302206	A

TITLE: R1966CKKEP

E-SWITCH®