

Excellent Integrated System Limited

Stocking Distributor

Click to view price, real time Inventory, Delivery & Lifecycle Information:

[E-Switch](#)
[R1973ABLKBLKAR0](#)

For any questions, you can email us directly:
sales@integrated-circuit.com

SHEET OF

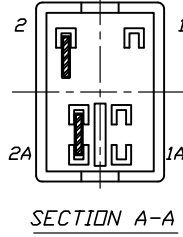
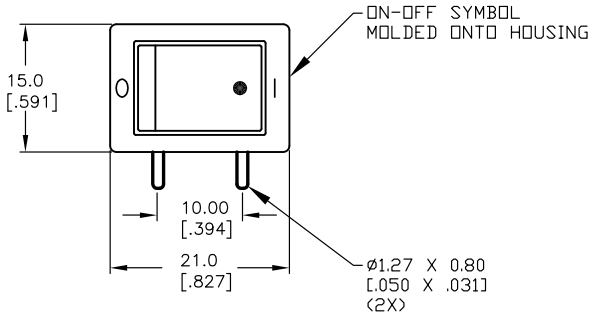

PANEL THICKNESS		X dimension
0.75-1.25	[.030-.049]	19.2-0.1 [L.756]
1.25-2.0	[.049-.079]	19.4-0.1 [L.764]
2.0-3.0	[.079-.118]	19.8-0.1 [L.780]

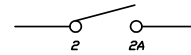
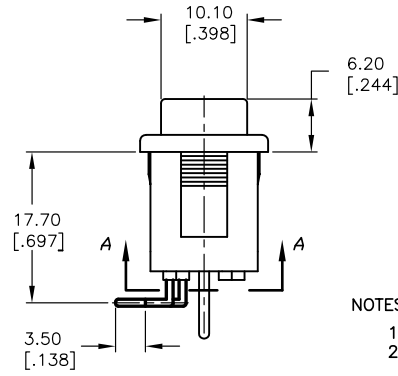
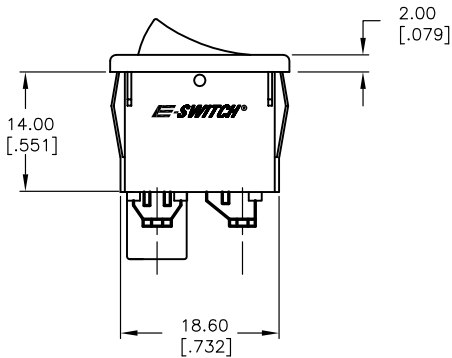
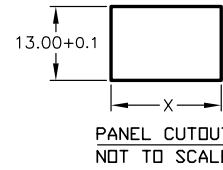

CIRCUIT: SPST

NOTES:

- ALL DIMENSIONS IN MM [INCH]
- GENERAL TOLERANCE: X.X=±0.4
X.XX=±0.25
- RATING:
6A @250VAC;9A @125VAC (UL, CSA, VDE)
4(1)A @250VAC
- MATERIAL:
CONTACT SURFACE: Coin Silver, Silver Plate
TERMINAL: Copper Alloy W/ Silver Plate.
- CONTACT RESISTANCE: 20mILLIOHMS TYP. INITIAL
- INSULATION RESISTANCE: 1000MegaOHMS
- DIELECTRIC STRENGTH:
>1500V RMS min. @SEA LEVEL
>3000V RMS @SEA LEVEL
- MECHANICAL LIFE: 50,000 CYCLES.
- ELECTRICAL LIFE: 10,000 CYCLES.

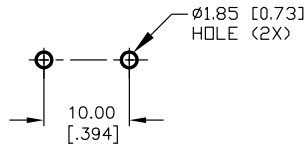

RECOMMENDED P.C.B. HOLES

E-SWITCH®

TITLE					R1973ABLKBLKAR0				
SCALE	DATE	DR	DWG	REV	SCALE	DATE	DR	DWG	REV
1.5:1	10/20/01	AR	M400101	B					

REV.	ECN No.	DESCRIPTION	DATE	CHKD
A	13816	REDRAWN AND RE-RELEASED	3/4/04	AR

THE INFORMATION CONTAINED IN THIS DOCUMENT IS PROPRIETARY TO E-SWITCH AND IS NOT TO BE COPIED OR TRANSFERRED