



Distributor of Molex Connector Corporation: Excellent Integrated System Limited
Datasheet of 0475890001 - Connector Receptacle USB micro AB 5 Position Surface Mount,
Right Angle, Horizontal

Contact us: sales@integrated-circuit.com Website: www.integrated-circuit.com

Excellent Integrated System Limited

Stocking Distributor

Click to view price, real time Inventory, Delivery & Lifecycle Information:

[Molex Connector Corporation](#)
[0475890001](#)

For any questions, you can email us directly:
sales@integrated-circuit.com

Contact us: sales@integrated-circuit.com Website: www.integrated-circuit.com

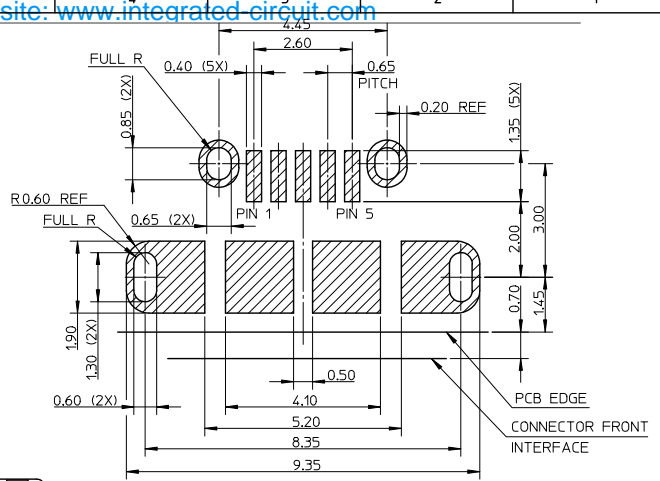
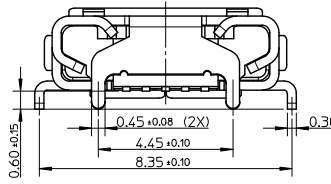
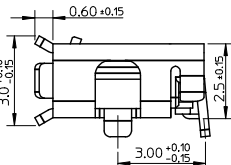
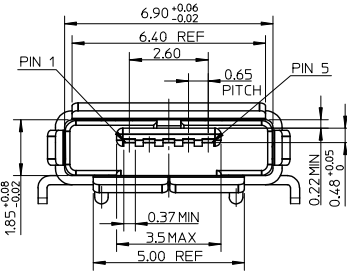
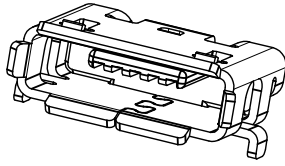
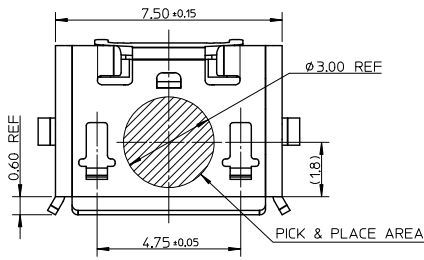

RECOMMENDED P.C.B. PATTERN LAYOUT
GENERAL TOLERANCE: ±0.05

NOTES:

- MATERIAL:
HOUSING: LCP, BLACK, UL94V-0;
TERMINAL: COPPER ALLOY, THICKNESS: 0.15mm;
SHELL: STAINLESS STEEL, THICKNESS: 0.30mm.
- PLATING:
TERMINAL: CONTACT AREA: GOLD FLASH (0.11 MICRON MIN.) OVER MINIMUM 0.75 MICRON Pd/Ni.
SOLDER TAIL AREA: GOLD FLASH (0.05 MICRON MINIMUM).
UNDER PLATING: NICKEL 2.0 MICROMN MINIMUM.
SHELL: MATTE TIN 1.27 MICRON MINIMUM.
UNDER PLATING: NICKEL 1.27 MICRON MINIMUM.
- TAIL COPLANARITY 0.08mm MAXIMUM.
- PRODUCT SPECIFICATION: PS-47589-001.
- PACKAGING SPECIFICATION: PK-47589-001.
- COMPLIANT TO RoHS DIRECTIVE 2002/95/EC AND ELV 2000/53/EC.

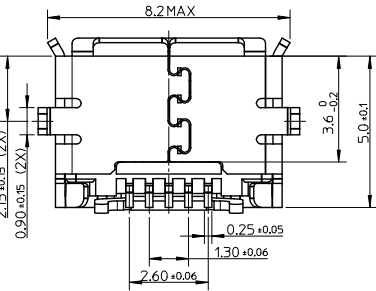

REVISED EC NO. SH2014-0260 DRAWN: XZHUANG 2013/12/23 CHKD: XZHUANG 2013/12/23 APPR: AYIN 2014/02/11	DESCRIPTION	QUALITY SYMBOLS	GENERAL TOLERANCES (UNLESS SPECIFIED)		DIMENSION STYLE		SCALE	DESIGN UNITS	THIRD ANGLE PROJECTION
			mm	INCH	MM ONLY	1:1	METRIC		
		▽=0	4 PLACES ±---	±---	DRAWN BY	DATE	TITLE		
		▽=0	3 PLACES ±---	±---	X JSONG	2007/03/06	MICRO USB AB REC. BOTTOM MOUNT ASS'Y		
		▽=0	2 PLACES ±0.15	±---	CHECKED BY	DATE			
		▽=0	1 PLACE ±0.25	±---	JTIAN	2007/03/06			
		▽=0	0 PLACE ±	±	APPROVED BY	DATE	DOCUMENT NO.		
			ANGULAR ± 3 °		JNCHEN	2007/03/06	47589-0001 SD-47589-001		
			DRAFT WHERE APPLICABLE MUST REMAIN WITHIN DIMENSIONS		MATERIAL NO.	47589-0001	SHEET NO. 1 OF 1		
					SIZE	A3	THIS DRAWING CONTAINS INFORMATION THAT IS PROPRIETARY TO MOLEX INCORPORATED AND SHOULD NOT BE USED WITHOUT WRITTEN PERMISSION		