

## Excellent Integrated System Limited

Stocking Distributor

Click to view price, real time Inventory, Delivery & Lifecycle Information:

[STMicroelectronics](#)  
[T2035H-6T](#)

For any questions, you can email us directly:

[sales@integrated-circuit.com](mailto:sales@integrated-circuit.com)



# T2035H, T2050H

## High temperature 20 A Snubberless™ Triacs

### Features

- Medium current Triac
- 150 °C max.  $T_j$  turn-off commutation
- Low thermal resistance with clip bonding
- Very high 3 quadrant commutation capability
- Packages are RoHS (2002/95/EC) compliant
- UL certified (ref. file E81734)

### Applications

Especially designed to operate in high power density or universal motor applications such as vacuum cleaner and washing machine drum motor.

### Description

Available in through-hole and surface mount packages, the T2035H and T2050H Triac series are suitable for general purpose mains power AC switching.

These 20 A Triacs provide a very high switching capability up to junction temperatures of 150 °C.

The heatsink can be reduced, compared to traditional Triacs, according to the high performance at given junction temperatures.

By using an internal ceramic pad, the T20xxH-6I provides voltage insulation (rated at 2500 V rms).

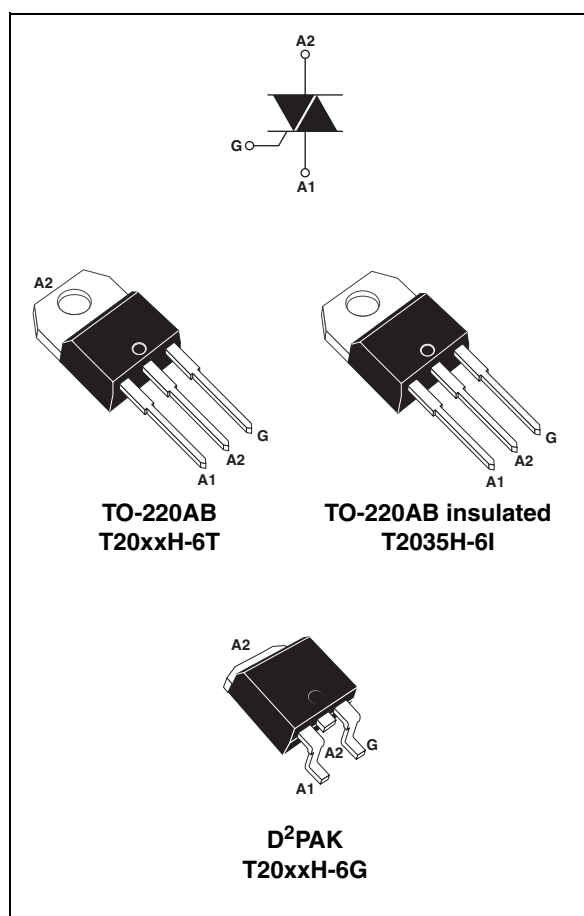

**Table 1. Device summary**

Symbol	Value	Unit
$I_{T(RMS)}$	20	A
$V_{DRM}/V_{RRM}$	600	V
$I_{GT}$	35 or 50	mA

**TM:** Snubberless is a trademark of STMicroelectronics

Characteristics

T2035H, T2050H

# 1 Characteristics

**Table 2. Absolute maximum ratings**

Symbol	Parameter		Value	Unit	
$I_{T(RMS)}$	On-state rms current (full sine wave)	TO-220AB, D <sup>2</sup> PAK	$T_c = 128\text{ °C}$	20	A
		TO-220AB insulated	$T_c = 108\text{ °C}$		
$I_{TSM}$	Non repetitive surge peak on-state current (full cycle, $T_j$ initial = 25 °C)	F = 50 Hz	t = 20 ms	200	A
		F = 60 Hz	t = 16.7 ms	210	
$I^2t$	$I^2t$ Value for fusing	$t_p = 10\text{ ms}$		265	A <sup>2</sup> s
dI/dt	Critical rate of rise of on-state current $I_G = 2 \times I_{GT}$ , $t_r \leq 100\text{ ns}$	F = 120 Hz	$T_j = 150\text{ °C}$	50	A/ $\mu$ s
$V_{DSM}/V_{RSM}$	Non repetitive surge peak off-state voltage	$t_p = 10\text{ ms}$	$T_j = 25\text{ °C}$	$V_{DRM}/V_{RRM} + 100$	V
$I_{GM}$	Peak gate current	$t_p = 20\text{ }\mu$ s	$T_j = 150\text{ °C}$	4	A
$P_{G(AV)}$	Average gate power dissipation	$T_j = 150\text{ °C}$		1	W
$T_{stg}$ $T_j$	Storage junction temperature range Operating junction temperature range			- 40 to + 150 - 40 to + 150	°C

**Table 3. Electrical characteristics ( $T_j = 25\text{ °C}$ , unless otherwise specified)**

Symbol	Test conditions	Quadrant	Value		Unit	
			T2035H	T2050H		
$I_{GT}^{(1)}$	$V_D = 12\text{ V}$ , $R_L = 33\text{ }\Omega$	I - II - III	MAX.	35	50	mA
$V_{GT}$		I - II - III	MAX.	1.0		V
$V_{GD}$	$V_D = V_{DRM}$ , $R_L = 3.3\text{ k}\Omega$	I - II - III	MIN.	0.15		V
$I_H^{(2)}$	$I_T = 500\text{ mA}$		MAX.	35	75	mA
$I_L$	$I_G = 1.2 I_{GT}$	I - III	MAX.	50	90	mA
		II		80	110	
dV/dt <sup>(2)</sup>	$V_D = 67\% V_{DRM}$ , gate open, $T_j = 150\text{ °C}$		MIN.	1000	1500	V/ $\mu$ s
$(dI/dt)_c^{(2)}$	Without snubber, $T_j = 150\text{ °C}$		MIN.	27	36	A/ms

1. minimum  $I_{GT}$  is guaranteed at 20% of  $I_{GT}$  max.

2. for both polarities of A2 referenced to A1.

**T2035H, T2050H**

**Characteristics**

**Table 4. Static characteristics**

Symbol	Test conditions			Value	Unit
$V_T^{(1)}$	$I_{TM} = 28\text{ A}$ , $t_p = 380\ \mu\text{s}$	$T_j = 25\ ^\circ\text{C}$	MAX.	1.5	V
$V_{T0}^{(1)}$	Threshold voltage	$T_j = 150\ ^\circ\text{C}$	MAX.	0.80	V
$R_d^{(1)}$	Dynamic resistance	$T_j = 150\ ^\circ\text{C}$	MAX.	19	m $\Omega$
$I_{DRM}$ $I_{RRM}^{(2)}$	$V_{DRM} = V_{RRM}$	$T_j = 25\ ^\circ\text{C}$	MAX.	5	$\mu\text{A}$
		$T_j = 150\ ^\circ\text{C}$	MAX.	6.2	mA
	$V_D/V_R = 400\ \text{V}$ (at peak mains voltage)	$T_j = 150\ ^\circ\text{C}$	MAX.	5.0	
	$V_D/V_R = 200\ \text{V}$ (at peak mains voltage)	$T_j = 150\ ^\circ\text{C}$	MAX.	4.0	

- for both polarities of A2 referenced to A1.
- $t_p = 380\ \mu\text{s}$ .

**Table 5. Thermal resistance**

Symbol	Parameter		Value	Unit
$R_{th(j-c)}$	Junction to case (AC)	TO-220AB, D <sup>2</sup> PAK	1	$^\circ\text{C/W}$
		TO-220AB Ins	1.9	
$R_{th(j-a)}$	Junction to ambient	TO-220AB, TO-220AB insulated	60	
		$S = 1\ \text{cm}^2$ D <sup>2</sup> PAK	45	

**Characteristics**

**T2035H, T2050H**

**Figure 1. Maximum power dissipation versus on-state rms current**

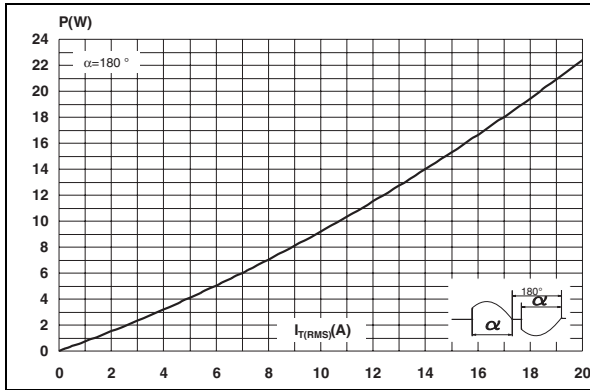

**Figure 2. On-state rms current versus case temperature**

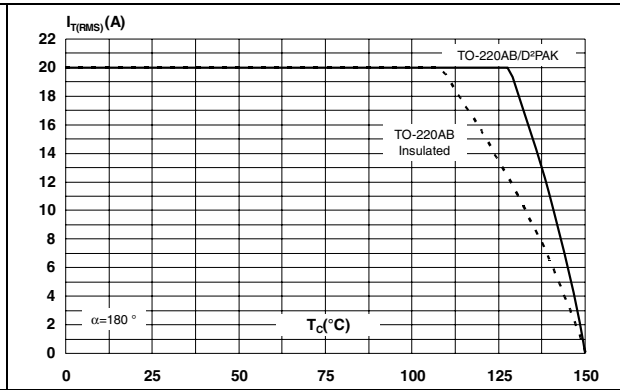

**Figure 3. On-state rms current versus ambient temperature**

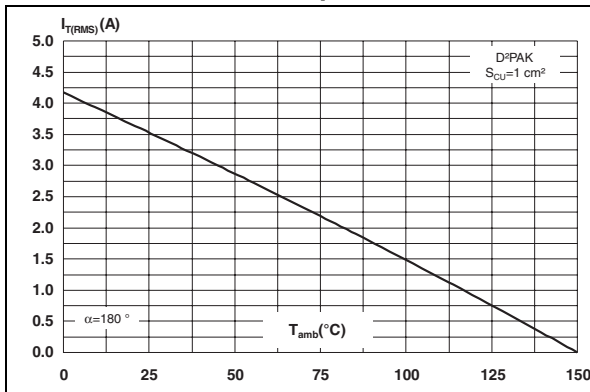

**Figure 4. Variation of thermal impedance versus pulse duration**

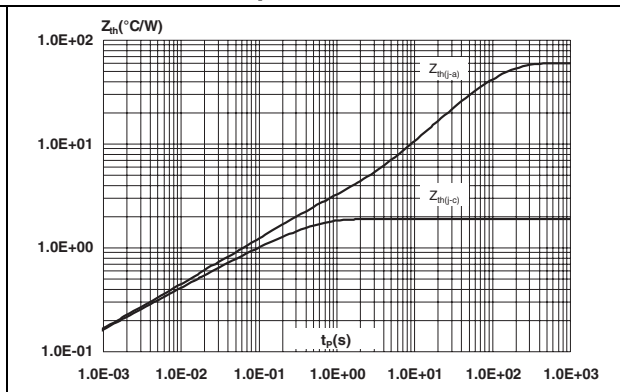

**Figure 5. On-state characteristics (maximum values)**

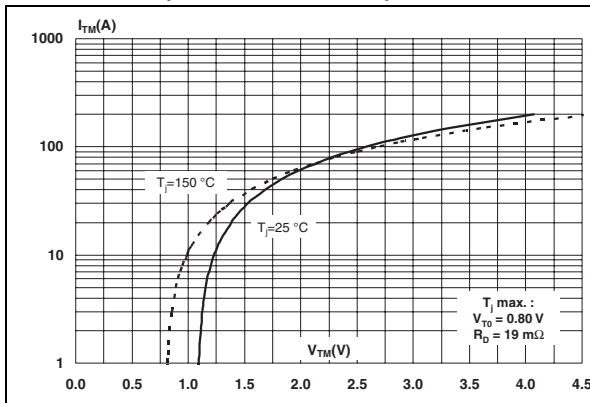

**Figure 6. Surge peak on-state current versus number of cycles**

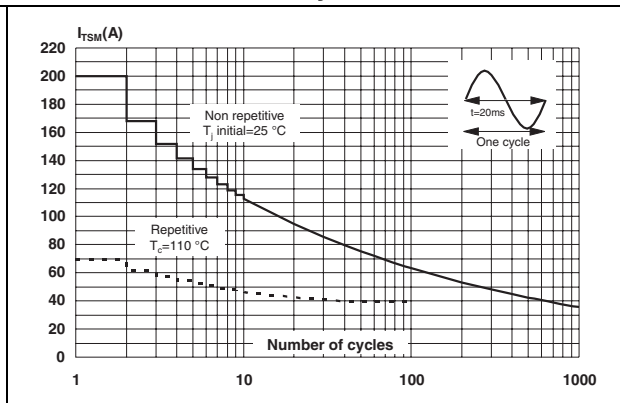

**T2035H, T2050H**

**Characteristics**

**Figure 7. Non-repetitive surge peak on-state current and corresponding values of  $I^2t$**

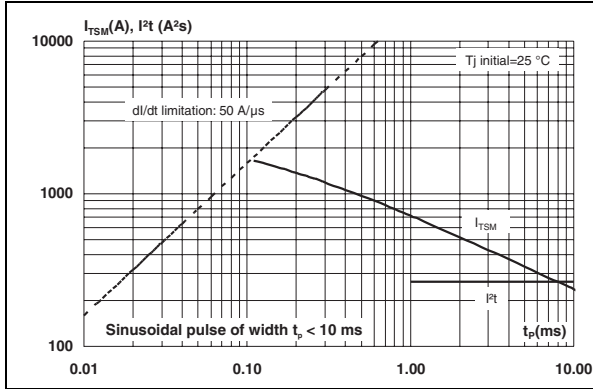

**Figure 8. Relative variation of  $I_{GT}, I_H, I_L$  versus junction temperature (typical values)**

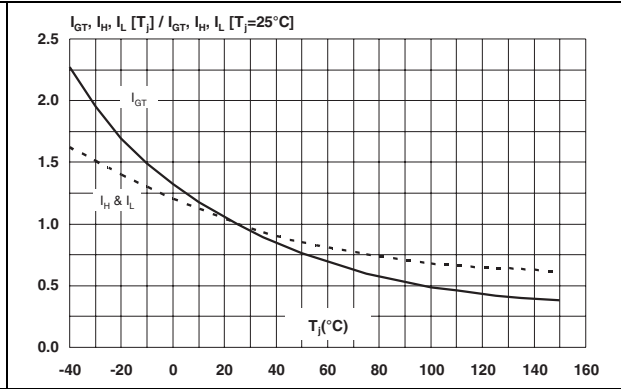

**Figure 9. Relative variation of critical rate of decrease of main current  $(di/dt)_c$  versus reappplied  $(dV/dt)_c$**

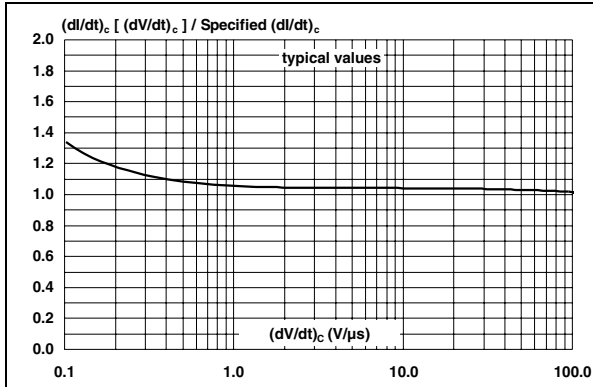

**Figure 10. Relative variation of critical rate of decrease of main current versus junction temperature**

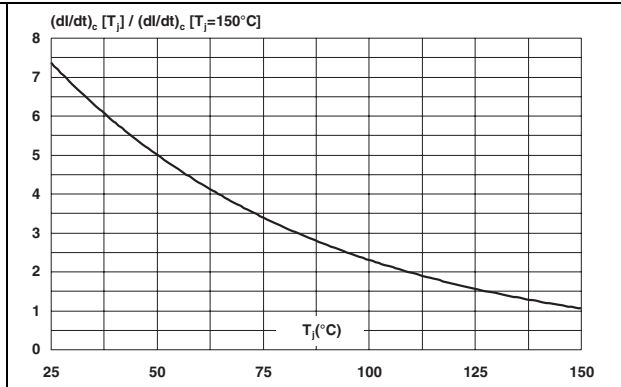

**Figure 11. Leakage current versus junction temperature for different values of blocking voltage (typical values)**

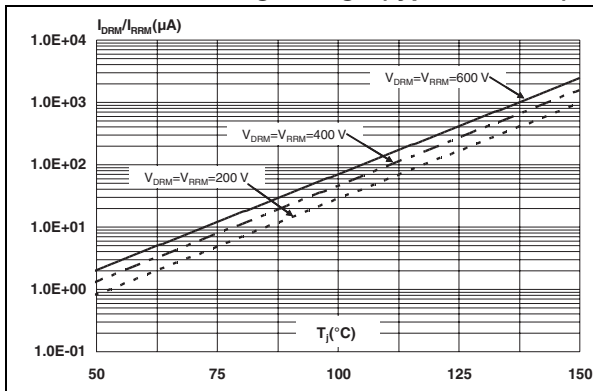

**Figure 12. Acceptable repetitive peak off-state voltage versus case to ambient thermal resistance**

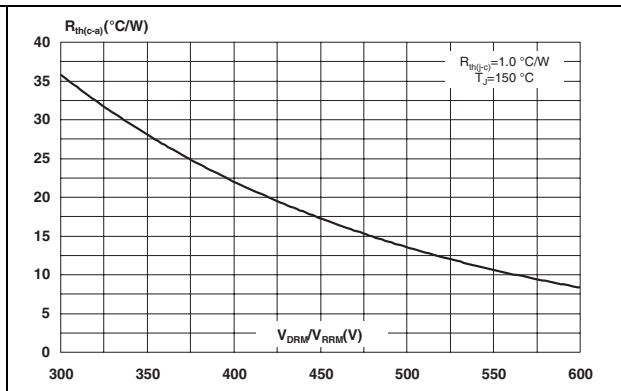

**Ordering information**

**T2035H, T2050H**

**Figure 13. Thermal resistance junction to ambient versus copper surface under tab**

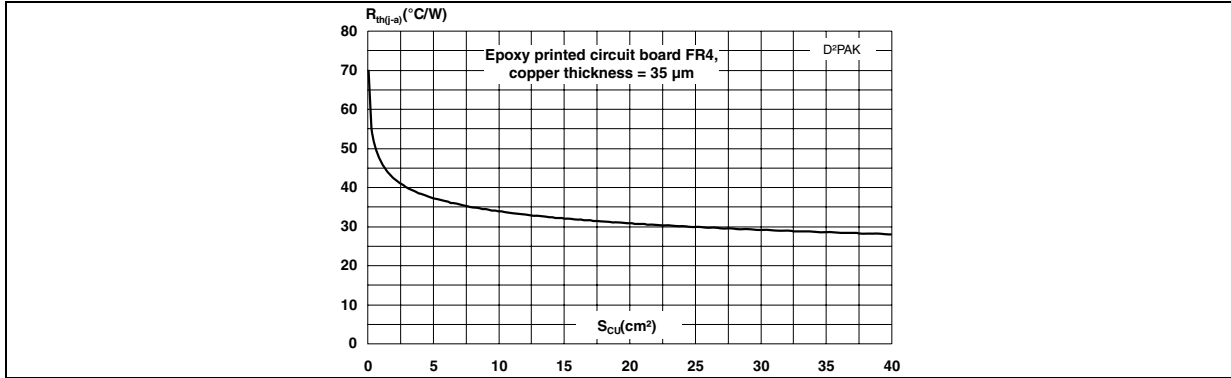

## 2 Ordering information

**Figure 14. Ordering information**

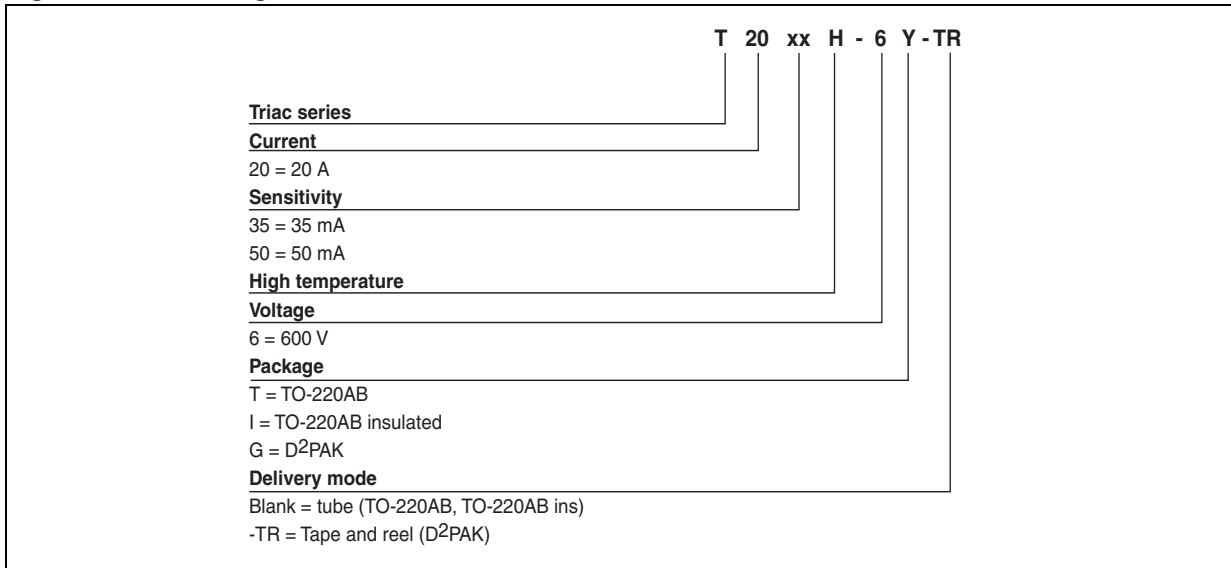

### 3 Package information

- Epoxy meets UL94, V0
- Recommended torque 0.4 to 0.6 N·m

In order to meet environmental requirements, ST offers these devices in different grades of ECOPACK® packages, depending on their level of environmental compliance. ECOPACK® specifications, grade definitions and product status are available at: [www.st.com](http://www.st.com). ECOPACK® is an ST trademark.

Table 6. TO-220AB and TO-220AB insulated dimensions

Ref.	Dimensions					
	Millimeters			Inches		
	Min.	Typ.	Max.	Min.	Typ.	Max.
A	15.20		15.90	0.598		0.625
a1		3.75			0.147	
a2	13.00		14.00	0.511		0.551
B	10.00		10.40	0.393		0.409
b1	0.61		0.88	0.024		0.034
b2	1.23		1.32	0.048		0.051
C	4.40		4.60	0.173		0.181
c1	0.49		0.70	0.019		0.027
c2	2.40		2.72	0.094		0.107
e	2.40		2.70	0.094		0.106
F	6.20		6.60	0.244		0.259
ØI	3.75		3.85	0.147		0.151
I4	15.80	16.40	16.80	0.622	0.646	0.661
L	2.65		2.95	0.104		0.116
I2	1.14		1.70	0.044		0.066
I3	1.14		1.70	0.044		0.066
M		2.60			0.102	

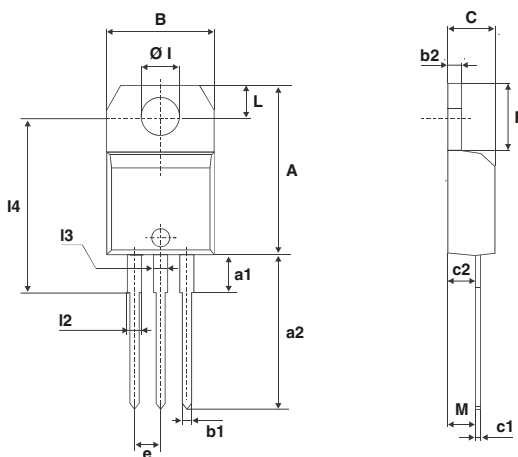



**Package information**

**T2035H, T2050H**

**Table 7. D<sup>2</sup>PAK dimensions**

Ref.	Dimensions					
	Millimeters			Inches		
	Min.	Typ.	Max.	Min.	Typ.	Max.
A	4.30		4.60	0.169		0.181
A1	2.49		2.69	0.098		0.106
A2	0.03		0.23	0.001		0.009
B	0.70		0.93	0.027		0.037
B2	1.25	1.40		0.048	0.055	
C	0.45		0.60	0.017		0.024
C2	1.21		1.36	0.047		0.054
D	8.95		9.35	0.352		0.368
E	10.00		10.28	0.393		0.405
G	4.88		5.28	0.192		0.208
L	15.00		15.85	0.590		0.624
L2	1.27		1.40	0.050		0.055
L3	1.40		1.75	0.055		0.069
R	0.40			0.016		
V2	0°		8°	0°		8°

**Figure 15. D<sup>2</sup>PAK footprint (dimensions in mm)**

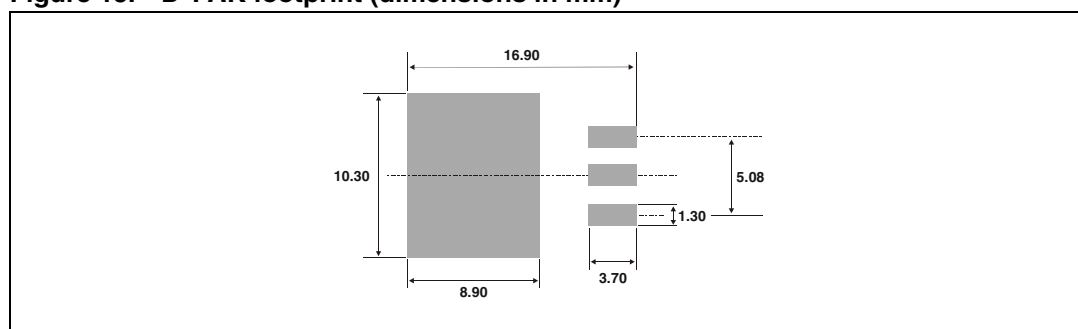

T2035H, T2050H

Ordering information

## 4 Ordering information

Table 8. Ordering information

Order code	Marking	Package	Weight	Base qty	Delivery mode
T20xxH-6T	T20xxH 6T	TO-220AB	2.3 g	50	Tube
T20xxH-6I	T20xxH 6T	TO-220AB insulated	2.3 g	50	Tube
T20xxH-6G-TR	T20xxH 6G	D <sup>2</sup> PAK	1.5 g	1000	Tape and reel

## 5 Revision history

Table 9. Document revision history

Date	Revision	Changes
31-May-2007	1	First issue.
15-Nov-2007	2	Added TO-220AB Ins and D <sup>2</sup> PAK packages. Reformatted to current standards.
08-Aug-2011	3	Updated: <i>Features</i> and <i>Description</i> . Removed order code T20xxH-6G from <i>Figure 14</i> and <i>Table 8</i> .

---

## T2035H, T2050H

---

### **Please Read Carefully:**

Information in this document is provided solely in connection with ST products. STMicroelectronics NV and its subsidiaries ("ST") reserve the right to make changes, corrections, modifications or improvements, to this document, and the products and services described herein at any time, without notice.

All ST products are sold pursuant to ST's terms and conditions of sale.

Purchasers are solely responsible for the choice, selection and use of the ST products and services described herein, and ST assumes no liability whatsoever relating to the choice, selection or use of the ST products and services described herein.

No license, express or implied, by estoppel or otherwise, to any intellectual property rights is granted under this document. If any part of this document refers to any third party products or services it shall not be deemed a license grant by ST for the use of such third party products or services, or any intellectual property contained therein or considered as a warranty covering the use in any manner whatsoever of such third party products or services or any intellectual property contained therein.

**UNLESS OTHERWISE SET FORTH IN ST'S TERMS AND CONDITIONS OF SALE ST DISCLAIMS ANY EXPRESS OR IMPLIED WARRANTY WITH RESPECT TO THE USE AND/OR SALE OF ST PRODUCTS INCLUDING WITHOUT LIMITATION IMPLIED WARRANTIES OF MERCHANTABILITY, FITNESS FOR A PARTICULAR PURPOSE (AND THEIR EQUIVALENTS UNDER THE LAWS OF ANY JURISDICTION), OR INFRINGEMENT OF ANY PATENT, COPYRIGHT OR OTHER INTELLECTUAL PROPERTY RIGHT.**

**UNLESS EXPRESSLY APPROVED IN WRITING BY TWO AUTHORIZED ST REPRESENTATIVES, ST PRODUCTS ARE NOT RECOMMENDED, AUTHORIZED OR WARRANTED FOR USE IN MILITARY, AIR CRAFT, SPACE, LIFE SAVING, OR LIFE SUSTAINING APPLICATIONS, NOR IN PRODUCTS OR SYSTEMS WHERE FAILURE OR MALFUNCTION MAY RESULT IN PERSONAL INJURY, DEATH, OR SEVERE PROPERTY OR ENVIRONMENTAL DAMAGE. ST PRODUCTS WHICH ARE NOT SPECIFIED AS "AUTOMOTIVE GRADE" MAY ONLY BE USED IN AUTOMOTIVE APPLICATIONS AT USER'S OWN RISK.**

Resale of ST products with provisions different from the statements and/or technical features set forth in this document shall immediately void any warranty granted by ST for the ST product or service described herein and shall not create or extend in any manner whatsoever, any liability of ST.

ST and the ST logo are trademarks or registered trademarks of ST in various countries.

Information in this document supersedes and replaces all information previously supplied.

The ST logo is a registered trademark of STMicroelectronics. All other names are the property of their respective owners.

© 2011 STMicroelectronics - All rights reserved

STMicroelectronics group of companies

Australia - Belgium - Brazil - Canada - China - Czech Republic - Finland - France - Germany - Hong Kong - India - Israel - Italy - Japan - Malaysia - Malta - Morocco - Philippines - Singapore - Spain - Sweden - Switzerland - United Kingdom - United States of America

[www.st.com](http://www.st.com)