

Excellent Integrated System Limited

Stocking Distributor

Click to view price, real time Inventory, Delivery & Lifecycle Information:

[Micro Commercial Components \(MCC\)](#)
[ESD5V0L4-TP](#)

For any questions, you can email us directly:

sales@integrated-circuit.com

M.C.C.

Micro Commercial Components



Micro Commercial Components
20736 Marilla Street Chatsworth
Chatsworth, CA 91311
Phone: (818) 701-4933
Fax: (818) 701-4939

Features

- Halogen free available upon request by adding suffix "-HF"
- For sensitive ESD protection
- Excellent clamping capability
- Low leakage
- ESD rating of class 3(>16KV)per Human Body Mode
- For space saving application
- Fast response ,response time less than 1ns.
- Epoxy meets UL 94 V-0 flammability rating
- Moisture Sensitivity Level 1

Maximum Ratings

- Operating Junction & Storage Temperature: -55°C to +150°C
- Maximum Thermal Resistance; 833°C/W Junction To Ambient

Parameter	Symbol	Limits	unit
IEC61000-4-2(ESD) Air Contact		±30 ±30	KV
ESD Voltage per human body mode		16	KV
per machine mode		400	V
Power Dissipation(Note 1)	Pd	150	mw
Peak Power Dissipation@8/20us	Ppk	200	W

1. Only 1 diode under power. For all 4 diodes under power, PD will be 25%. Mounted on FR-4 board with min pad.

Pin Configuration

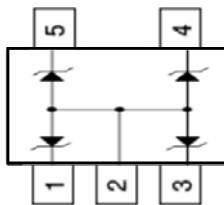

ESD5V0L4

**5 Volts
ESD Protection
Device**

SOT-553

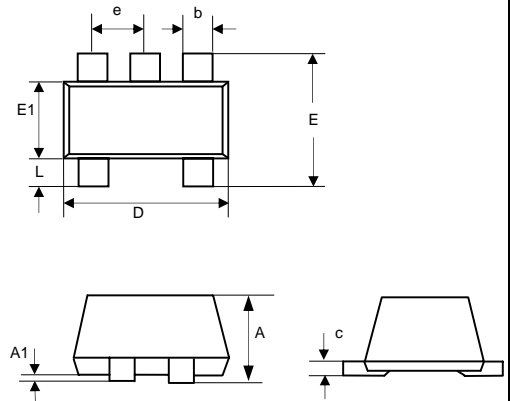

DIM	INCHES		MM	
	MIN	MAX	MIN	MAX
A	.021	.024	.525	.60
A1	.00	.002	.00	.05
e	.018	.022	.45	.55
c	.004	.006	.09	.16
D	.059	.067	1.5	1.7
b	.007	.011	.17	.27
E1	.043	.051	1.1	1.3
E	.059	.067	1.5	1.7
L	.004	.012	.100	.300

MCC

Micro Commercial Components

ELECTRICAL CHARACTERISTICS ($T_A = 25^\circ\text{C}$ unless otherwise noted, $V_F = 0.9\text{ V Max.}$ @ $I_F = 10\text{mA}$ for all types)

Device*	Device Marking	V_{RWM} (V)	I_R (μA) @ V_{RWM}	V_{BR} (V) @ I_T		I_T mA	V_F (V) @ $I_F=200\text{mA}$	V_C (V) @Max $I_{pp}=1\text{A}$	V_C (V) @Max $I_{pp}=5\text{A}$	C (pF) Max
		Max	Max	Min	Max		Max	Max	Max	
ESD5V0L4	42	5.0	5	6.0	7.2	1.0	1.25	10.5	13.5	80

1. Non-repetitive current per Figure 1. Derate per Figure 2.

TYPICAL CHARACTERISTICS

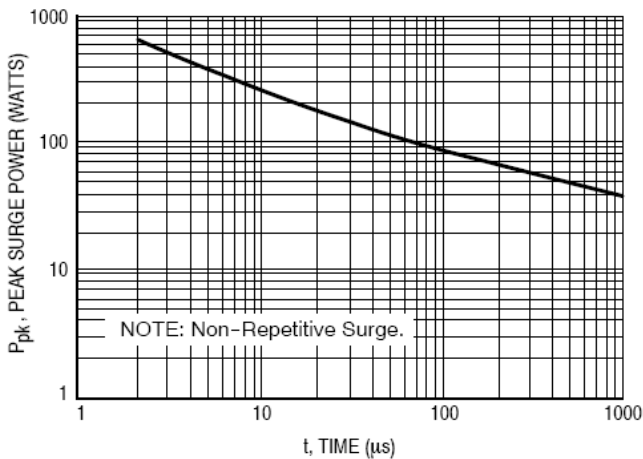

Figure 1. Pulse Width

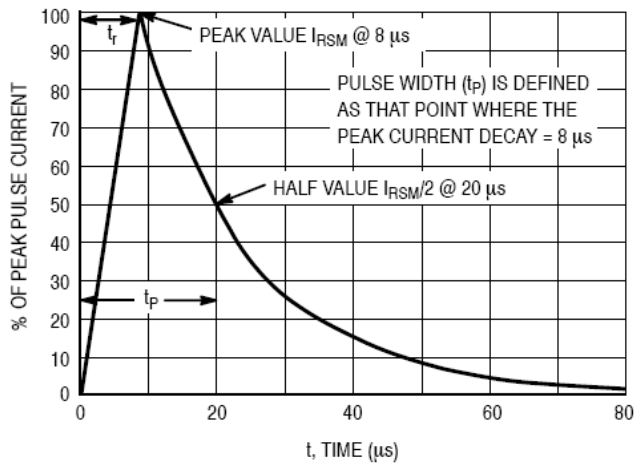

Figure 2. $8 \times 20\ \mu\text{s}$ Pulse Waveform



TM

Micro Commercial Components

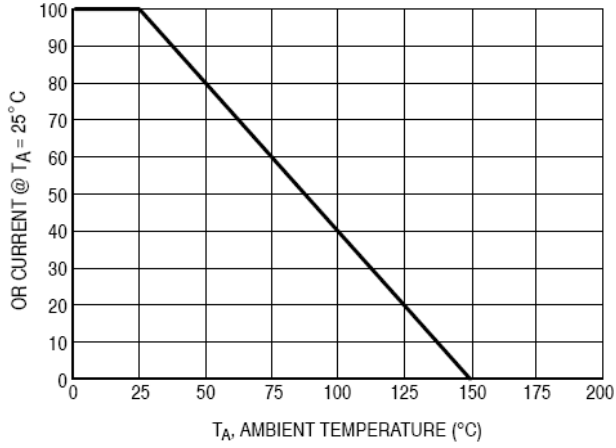

Figure 3. Pulse Derating Curve

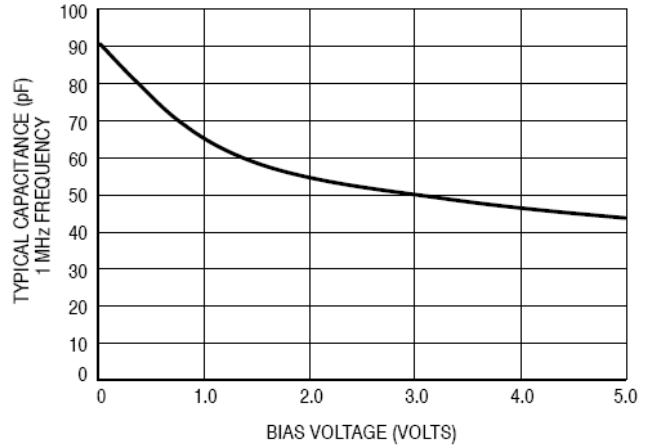

Figure 4. Capacitance

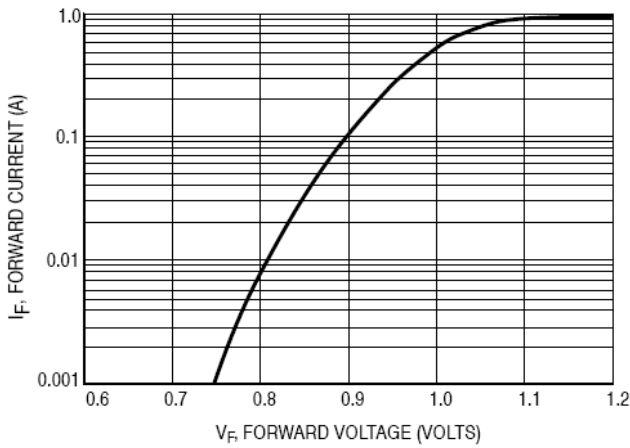

Figure 5. Forward Voltage

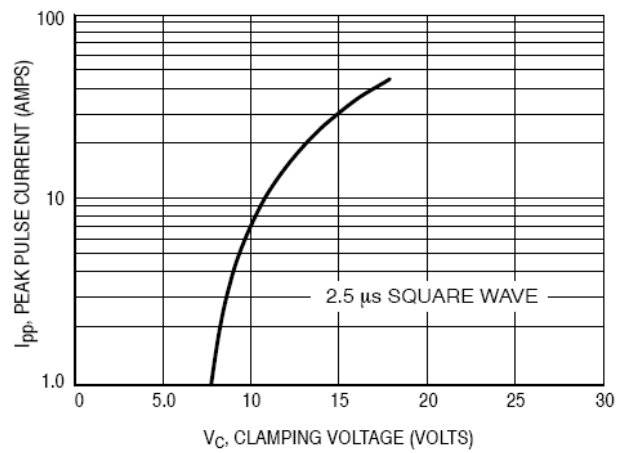

Figure 6. Clamping Voltage versus Peak Pulse Current (Reverse Direction)

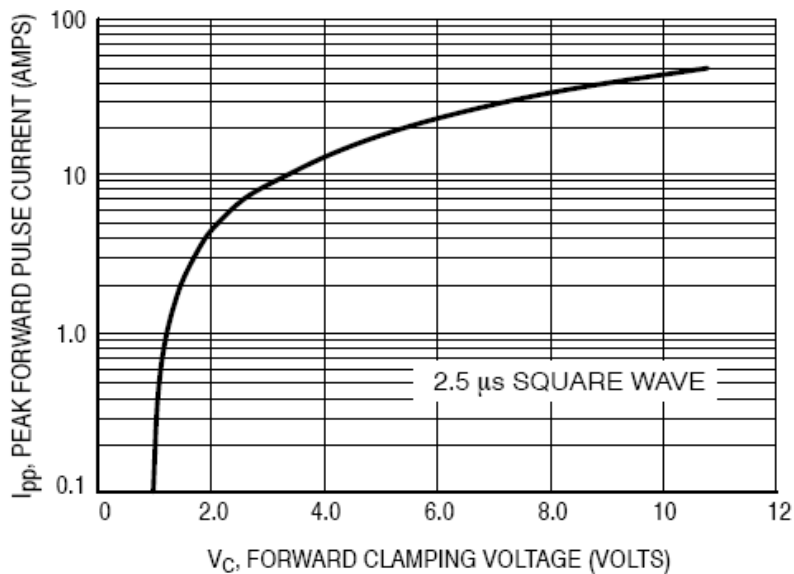

Figure 7. Clamping Voltage versus Peak Pulse Current (Forward Direction)



TM

Micro Commercial Components

Ordering Information :

Device	Packing
Part Number-TP	Tape&Reel: 3Kpcs/Reel

Note : Adding "-HF" suffix for halogen free, eg. Part Number-TP-HF

IMPORTANT NOTICE

Micro Commercial Components Corp. reserves the right to make changes without further notice to any product herein to make corrections, modifications , enhancements , improvements , or other changes . **Micro Commercial Components Corp .** does not assume any liability arising out of the application or use of any product described herein; neither does it convey any license under its patent rights ,nor the rights of others . The user of products in such applications shall assume all risks of such use and will agree to hold **Micro Commercial Components Corp .** and all the companies whose products are represented on our website, harmless against all damages.

LIFE SUPPORT

MCC's products are not authorized for use as critical components in life support devices or systems without the express written approval of Micro Commercial Components Corporation.

CUSTOMER AWARENESS

Counterfeiting of semiconductor parts is a growing problem in the industry. Micro Commercial Components (MCC) is taking strong measures to protect ourselves and our customers from the proliferation of counterfeit parts. MCC strongly encourages customers to purchase MCC parts either directly from MCC or from Authorized MCC Distributors who are listed by country on our web page cited below. Products customers buy either from MCC directly or from Authorized MCC Distributors are genuine parts, have full traceability, meet MCC's quality standards for handling and storage. **MCC will not provide any warranty coverage or other assistance for parts bought from Unauthorized Sources.** MCC is committed to combat this global problem and encourage our customers to do their part in stopping this practice by buying direct or from authorized distributors.