

Excellent Integrated System Limited

Stocking Distributor

Click to view price, real time Inventory, Delivery & Lifecycle Information:

[Schaffner EMC Inc.](#)
[FN350-8-29](#)

For any questions, you can email us directly:

sales@integrated-circuit.com

Compact EMC/RFI Filter for Motor Drives



- Compact filter solution for single-phase motor drive applications
- Industrial grade safety terminal blocks
- Designed to meet EN 55011/14/22
- Compliant with IEC 60950



Performance indicators

Attenuation performance



Rated current [A]



Approvals



Features and benefits

- High component values optimized for common and differential-mode attenuation in the lower frequency range makes this filter ideal for a large variety of single-phase motor drive applications
- Supplied in a relatively small housing design with safety terminal blocks for fast and easy installation in primarily industrial environments
- FN 350 also meets IEC 60950 requirements, thus providing additional application flexibility

Typical applications

- Single-phase motor drives
- Automation equipment
- Power supplies, SMPS
- Office equipment
- Testing and measurements equipment

Technical specifications

Maximum continuous operating voltage	1x 250 VAC
Operating frequency	dc to 400 Hz
Rated currents	8 to 55 A @ 40 °C
High potential test voltage	P → E 2000 VAC for 2 sec P → N 1100 VDC for 2 sec
Protection category	IP20
Overload capability	4x rated current at switch on, 1.5x rated current for 1 minute, once per hour
Temperature range (operation and storage)	-25 °C to +100 °C (25/100/21)
Flammability corresponding to	UL 94 V-2 or better
Design corresponding to	UL 1283, CSA 22.2 No. 8 1986, IEC/EN 60939
MTBF @ 40°C/230V (Mil-HB-217F)	420,000 hours

Typical electrical schematic

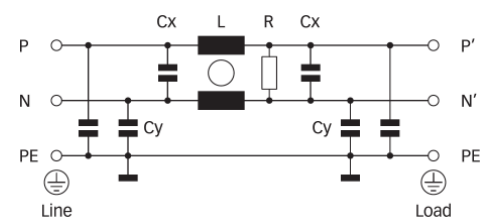

Filter selection table

Filter	Rated current @ 40 °C (25 °C)	Leakage current* @ 230 VAC/50 Hz	Power loss @ 25 °C/50 Hz	Input/Output connections	Weight
	[A]	[mA]	[W]		[kg]
FN 350-8-29	8 (9.0)	4.9	5.2	-29	0.7
FN 350-12-29	12 (13.5)	4.9	5.7	-29	0.7
FN 350-20-29	20 (22.4)	4.9	6.1	-29	0.7
FN 350-30-33	30 (33.6)	5.4	6.1	-33	0.7
FN 350-55-33	55 (61.5)	11.0	9.9	-33	1.2

* Maximum leakage under normal operating conditions. Note: if the neutral line is interrupted, worst case leakage could reach twice this level.

Typical filter attenuation

Per CISPR 17; A = 50 Ω/50 Ω sym; B = 50 Ω/50 Ω asym; C = 0.1 Ω/100 Ω sym; D = 100 Ω/0.1 Ω sym

8 A types

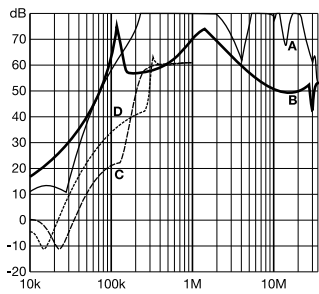

12 A types

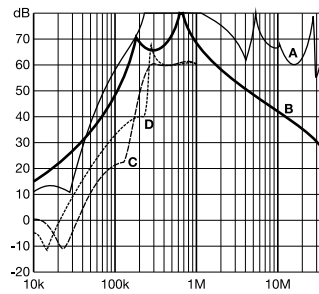

20 and 30 A types

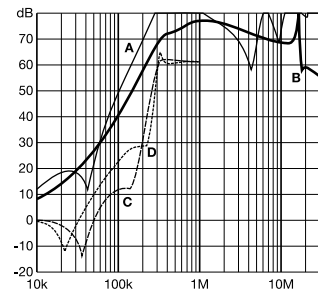

55 A types

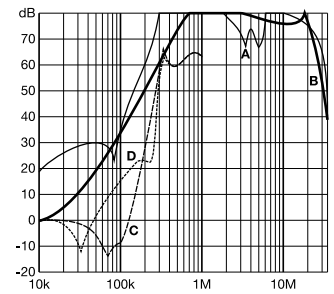

Mechanical data

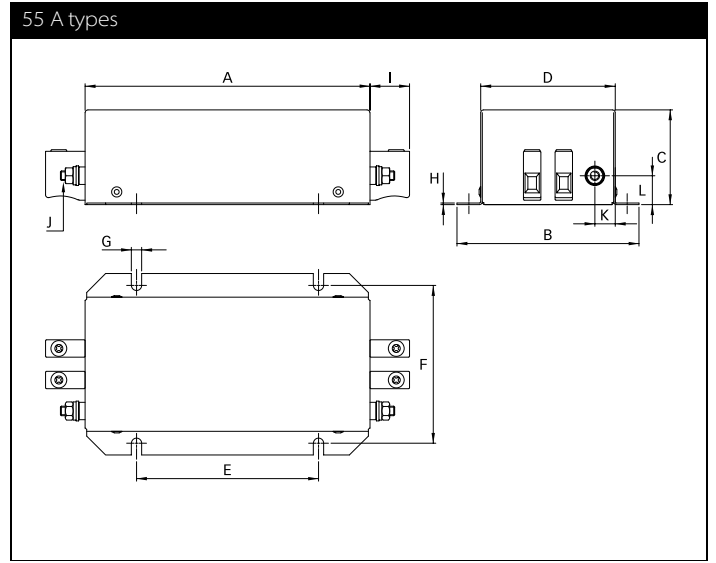
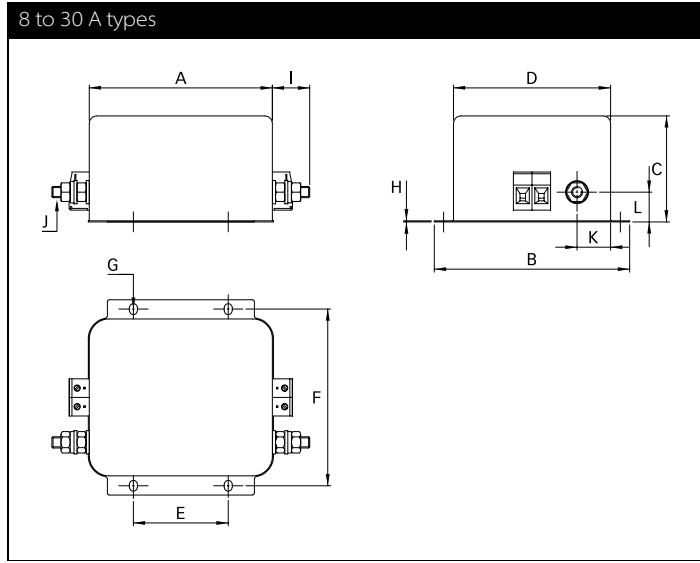

Dimensions

	8 A	12 A	20 A	30 A	55 A
A	99.5	99.5	99.5	99.5	180
B	105	105	105	105	115
C	57	57	57	57.6	60
D	84.4	84.4	84.4	84.4	85
E	51	51	51	51	115
F	95	95	95	95	100
G	6 x 4.4	6 x 4.4	6 x 4.4	6 x 4.4	6.5
H	0.6	0.6	0.6	1.2	1
I	19.5	19.5	19.5	25	25
J	M6	M6	M6	M6	M6
K	18	18	18	16	12.9
L	16	16	16	19	18.3

All dimensions in mm; 1 inch = 25.4 mm
Tolerances according: ISO 2768-m / EN 22768-m

Filter input/output connector cross sections

	-29	-33
Solid wire	6 mm ²	16 mm ²
Flex wire	4 mm ²	10 mm ²
AWG type wire	AWG 10	AWG 6
Recommended torque	0.6-0.8 Nm	1.5-1.8 Nm

Please visit www.schaffner.com to find more details on filter connectors.



Headquarters, global innovation and development center

Switzerland

Schaffner Group

Nordstrasse 11
 4542 Luterbach
 T +41 32 6816 626
 F +41 32 6816 630
info@schaffner.com
<http://www.schaffner.com>



Sales and application centers

China

Schaffner EMC Ltd. Shanghai

T20-3, No 565 Chuangye Road
 Pudong New Area
 201201 Shanghai
 T +86 21 3813 9500
 F +86 21 3813 9501 / 02
cschina@schaffner.com
<http://www.schaffner.com.cn/>

Finland

Schaffner Oy

Sauvonrinne 19 H
 08500 Lohja
 T +358 19 35 72 71
finlandsales@schaffner.com

France

Schaffner EMC S.A.S.

112, Quai de Bezons
 Boite postale 133
 95103 Argenteuil
 T +33 1 34 34 30 60
 F +33 1 39 47 02 28
francesales@schaffner.com

Germany

Schaffner Deutschland GmbH

Schoemperlenstrasse 12B
 76185 Karlsruhe
 T +49 721 56910
 F +49 721 569110
germanysales@schaffner.com

Italy

Schaffner EMC S.r.l.

Via Galileo Galilei 47
 20092 Cinisello Balsamo (MI)
 T +39 02 66 04 30 45/47
 F +39 02 61 23 943
italysales@schaffner.com

Japan

Schaffner EMC K.K.

1-32-12, Kamiyama, Setagaya-ku
 7F Mitsui-seimei Sangenjaya Bldg.
 154-0011 Tokyo
 T +81 3 5712 3650
 F +81 3 5712 3651
japansales@schaffner.com
<http://www.schaffner.jp>

Singapore

Schaffner EMC Pte Ltd.

Blk 3015A Ubi Road 1
 05-09 Kampong Ubi Industrial Estate
 408705 Singapore
 T +65 6377 3283
 F +65 6377 3281
singaporesales@schaffner.com

Spain

Schaffner EMC España

Calle Caléndula 93
 Miniparc III, Edificio E
 El Soto de la Moraleja
 Alcobendas
 28109 Madrid
 T +34 618 176 133
spainsales@schaffner.com

Sweden

Schaffner EMC AB

Turebergstorg 1, 6
 19147 Sollentuna
 T +46 8 5792 1121 / 22
 F +46 8 92 96 90
swedensales@schaffner.com

Switzerland

Schaffner EMV AG

Nordstrasse 11
 4542 Luterbach
 T +41 32 6816 626
 F +41 32 6816 641
sales@schaffner.ch

Taiwan R.O.C.

Schaffner EMV Ltd.

6 Floor, No. 413
 Rui Guang Road
 114 Neihu District Taipei City
 T +886 2 87525050
 F +886 2 87518086
taiwansales@schaffner.com

Thailand

Schaffner EMC Co. Ltd.

Northern Region Industrial Estate
 67 Moo 4 Tambon Ban Klang
 Amphur Muang P.O. Box 14
 51000 Lamphun
 T +66 53 58 11 04
 F +66 53 58 10 19
thailandsales@schaffner.com

UK

Schaffner Ltd.

5 Ashville Way
 Molly Millars Lane
 Wokingham
 RG41 2PL Berkshire
 T +44 118 9770070
 F +44 118 9792969
uksales@schaffner.com
<http://www.schaffner.uk.com>

USA

Schaffner EMC Inc.

52 Mayfield Avenue
 08837 Edison, New Jersey
 T +1 800 367 5566
 T +1 732 225 9533
 F +1 732 225 4789
usasales@schaffner.com
<http://www.schaffner.com/us>

Schaffner MTC LLC

6722 Thirlane Road
 24019 Roanoke, Virginia
 T +1 276 228 7943
 F +1 276 228 7953
<http://www.schaffner-mtc.com>

Schaffner Trencos LLC

2550 Brookpark Road
 44134 Cleveland, Ohio
 T +1 216 741 5282
 F +1 216 741 4860
www.schaffner-trencos.com

To find your local partner within Schaffner's global network: www.schaffner.com

© 2014 Schaffner Group

The content of this document has been carefully checked and understood. However, neither Schaffner nor its subsidiaries assume any liability whatsoever for any errors or inaccuracies of this document and the consequences thereof. Published specifications are subject to change without notice. Product suitability for any area of application must ultimately be determined by the customer. In all cases, products must never be operated outside their published specifications. Schaffner does not guarantee the availability of all published products. This disclaimer shall be governed by substantive Swiss law and resulting disputes shall be settled by the courts at the place of business of Schaffner Holding AG. Latest publications and a complete disclaimer can be downloaded from the Schaffner website. All trademarks recognized.