

Excellent Integrated System Limited

Stocking Distributor

Click to view price, real time Inventory, Delivery & Lifecycle Information:

[Diodes Incorporated](#)
[UF2001-T](#)

For any questions, you can email us directly:

sales@integrated-circuit.com

UF2001 - UF2007

2.0A ULTRA-FAST RECTIFIER

Features

- Diffused Junction
- Ultra-Fast Switching for High Efficiency
- Surge Overload Rating to 60A Peak
- Low Reverse Leakage Current
- **Lead Free Finish, RoHS Compliant (Note 4)**

Mechanical Data

- Case: DO-15
- Case Material: Molded Plastic. UL Flammability Classification Rating 94V-0
- Moisture Sensitivity: Level 1 per J-STD-020D
- Terminals: Finish – Tin. Solderable per MIL-STD-202, Method 208 (e3)
- Polarity: Cathode Band
- Marking: Type Number
- Ordering Information: See Page 3
- Weight: 0.4 grams (approximate)

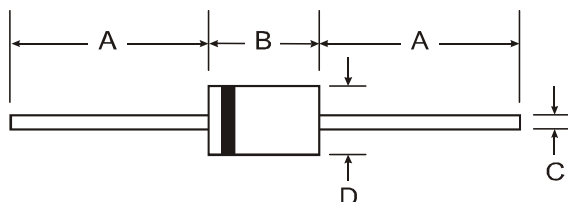

DO-15		
Dim	Min	Max
A	25.40	—
B	5.50	7.62
C	0.686	0.889
D	2.60	3.60
All Dimensions in mm		

Maximum Ratings and Electrical Characteristics

@T_A = 25°C unless otherwise specified

Single phase, half wave, 60Hz, resistive or inductive load.

For capacitive load, derate current by 20%.

Characteristic	Symbol	UF 2001	UF 2002	UF 2003	UF 2004	UF 2005	UF 2006	UF 2007	Unit
Peak Repetitive Reverse Voltage Working Peak Reverse Voltage DC Blocking Voltage (Note 5)	V _{RRM} V _{RWM} V _R	50	100	200	400	600	800	1000	V
RMS Reverse Voltage	V _{R(RMS)}	35	70	140	280	420	560	700	V
Average Rectified Output Current (Note 1) @ T _A = 50°C	I _O	2.0							A
Non-Repetitive Peak Forward Surge Current 8.3ms Single Half Sine-Wave Superimposed on Rated Load	I _{FSM}	60							A
Forward Voltage @ I _F = 2.0A	V _{FM}	1.0		1.3		1.7			V
Peak Reverse Current @ T _A = 25°C at Rated DC Blocking Voltage (Note 5) @ T _A = 100°C	I _{RM}	5.0 100							μA
Reverse Recovery Time (Note 3)	t _{rr}	50				75			ns
Typical Total Capacitance (Note 2)	C _T	50				30			pF
Typical Thermal Resistance Junction to Ambient	R _{θJA}	50							°C/W
Operating and Storage Temperature Range	T _J , T _{STG}	-65 to +150							°C

- Notes:
1. Valid provided that leads are maintained at ambient temperature at a distance of 9.5mm from the case.
 2. Measured at 1.0MHz and applied reverse voltage of 4.0V DC.
 3. Measured at I_F = 0.5A, I_R = 1.0A, I_{rr} = 0.25A. See figure 5.
 4. RoHS revision 13.2.2003. High temperature solder exemption applied, see *EU Directive Annex Note 7*.
 5. Short duration pulse test used to minimize self heating effect.

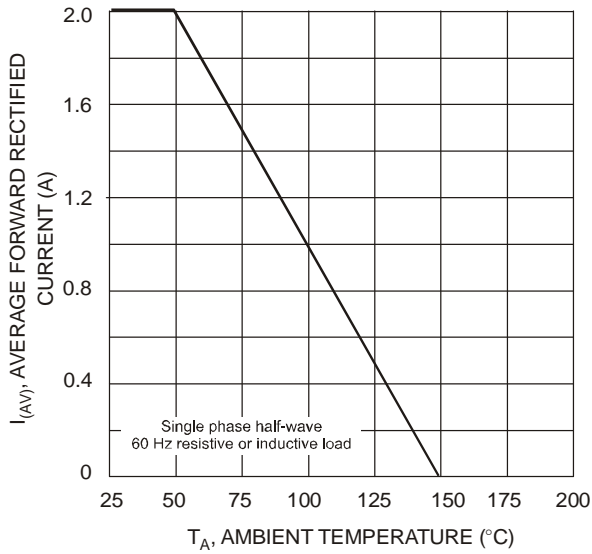

Fig. 1 Forward Current Derating Curve

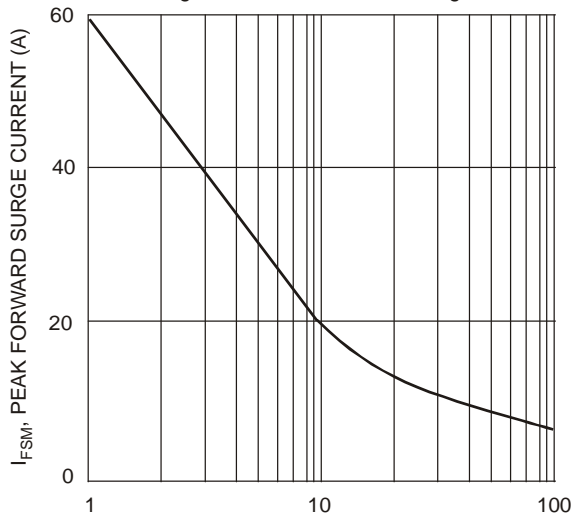
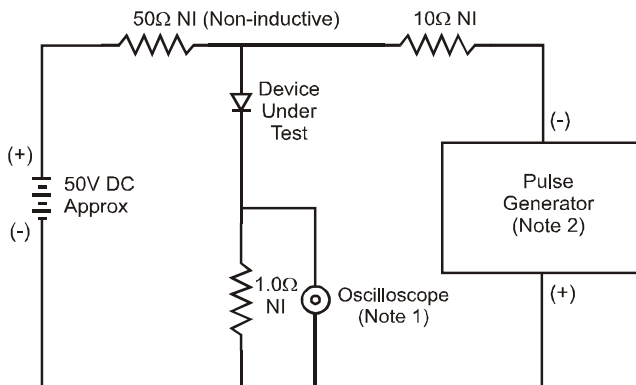

Fig. 3 Peak Forward Surge Current



Notes:

1. Rise Time = 7.0ns max. Input Impedance = 1.0MΩ, 22pF.
2. Rise Time = 10ns max. Input Impedance = 50Ω.

Fig. 5 Reverse Recovery Time Characteristic and Test Circuit

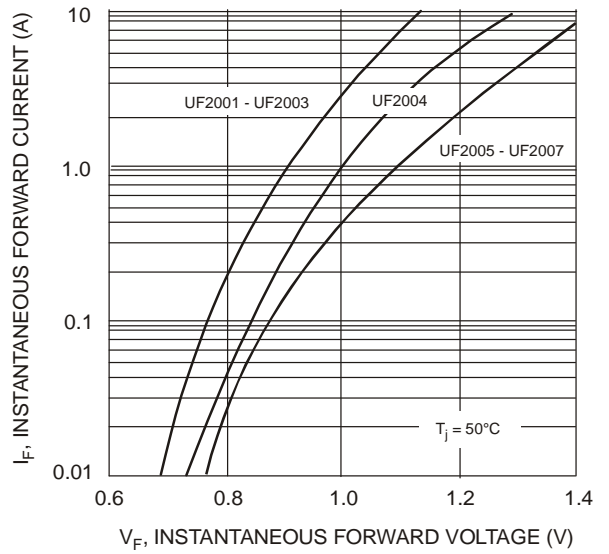

Fig. 2 Typical Forward Characteristics

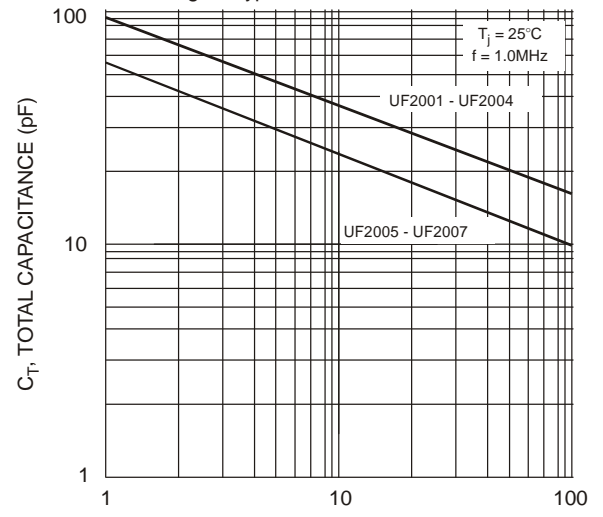
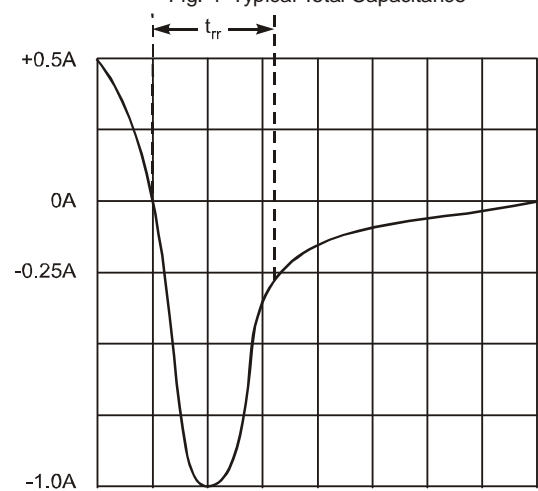

Fig. 4 Typical Total Capacitance



Set time base for 50/100 ns/cm



Ordering Information (Note 6)

Device	Packaging	Shipping
UF2001-T	DO-15	4K/Tape & Reel, 13-inch
UF2002-T	DO-15	4K/Tape & Reel, 13-inch
UF2003-T	DO-15	4K/Tape & Reel, 13-inch
UF2004-T	DO-15	4K/Tape & Reel, 13-inch
UF2005-T	DO-15	4K/Tape & Reel, 13-inch
UF2006-T	DO-15	4K/Tape & Reel, 13-inch
UF2007-T	DO-15	4K/Tape & Reel, 13-inch

Notes: 6. For packaging details, visit our website at <http://www.diodes.com/datasheets/ap02007.pdf>.

IMPORTANT NOTICE

Diodes Incorporated and its subsidiaries reserve the right to make modifications, enhancements, improvements, corrections or other changes without further notice to any product herein. Diodes Incorporated does not assume any liability arising out of the application or use of any product described herein; neither does it convey any license under its patent rights, nor the rights of others. The user of products in such applications shall assume all risks of such use and will agree to hold Diodes Incorporated and all the companies whose products are represented on our website, harmless against all damages.

LIFE SUPPORT

Diodes Incorporated products are not authorized for use as critical components in life support devices or systems without the expressed written approval of the President of Diodes Incorporated.