

Excellent Integrated System Limited

Stocking Distributor

Click to view price, real time Inventory, Delivery & Lifecycle Information:

[Maxim Integrated](#)
[MAX2363ETM+](#)

For any questions, you can email us directly:
sales@integrated-circuit.com

19-2013; Rev 2; 7/04



Complete Dual-Band Quadrature Transmitters

General Description

The MAX2361 dual-band, triple-mode complete transmitter for cellular phones represents an integrated and architecturally advanced solution for this application. The device takes a differential I/Q baseband input and converts it up to IF through a quadrature modulator and IF variable-gain amplifier (VGA). The signal is then routed to an external bandpass filter and upconverted to RF through an image-reject mixer and RF VGA. The signal is further amplified with an on-chip PA driver. An IF synthesizer, an RF synthesizer, a local oscillator (LO) buffer, and a 3-wire programmable bus complete the basic functional blocks of this IC. The MAX2363 supports single-band, single-mode (PCS) operation. The MAX2365 supports single-band cellular dual-mode operation.

The MAX2361 enables architectural flexibility because of its two IF voltage-controlled oscillators (VCOs), two IF ports, two RF LO input ports, and three PA driver output ports. The devices allow the use of a single receive IF frequency and split-band PCS filters for optimum out-of-band noise performance. The low-noise PA drivers allow up to three RF SAW filters to be eliminated. Select a mode of operation by loading data on the SPI™/QSPI™/MICROWIRE™-compatible 3-wire serial bus. Charge-pump current, IF/RF gain balancing, standby, shutdown plus additional functions, are also controlled with the serial interface.

The MAX2361/MAX2363/MAX2365 come in a 48-pin TQFN-EP and QFN-EP package and are specified for the extended (-40°C to +85°C) temperature range.

Applications

- CDMA, cdma2000™, TDMA, W-CDMA, GAIT Mobile Phones
- Satellite Phones
- Wireless Data Links (WAN/LAN)
- Wireless Local Area Networks (LANs)
- High-Speed Data Modems

Pin Configurations appear at end of data sheet.

Selector Guide appears at end of data sheet.

SPI and QSPI are trademarks of Motorola, Inc.

MICROWIRE is a trademark of National Semiconductor Corp.

cdma2000 is a trademark of Telecommunications Industry Association.

Features

- ◆ Dual-Band, Triple-Mode Operation
- ◆ +9dBm Linear Output Power
- ◆ 100dB Power-Control Range
- ◆ Supply Current Drops as Output Power is Reduced
- ◆ Dual Synthesizer for IF and RF LO
- ◆ Dual On-Chip IF VCO
- ◆ QSPI/SPI/MICROWIRE-Compatible 3-Wire Bus
- ◆ Digitally Controlled Operational Modes
- ◆ Single Sideband Upconverter Eliminates SAW Filters
- ◆ Directly Drives Power Amplifier

Ordering Information

PART	TEMP RANGE	PIN-PACKAGE
MAX2361EGM	-40°C to +85°C	48 QFN-EP*
MAX2361ETM	-40°C to +85°C	48 TQFN-EP*
MAX2363EGM	-40°C to +85°C	48 QFN-EP*
MAX2363ETM	-40°C to +85°C	48 TQFN-EP*
MAX2365EGM	-40°C to +85°C	48 QFN-EP*
MAX2365ETM	-40°C to +85°C	48 TQFN-EP*

*EP = exposed paddle.

Functional Diagram

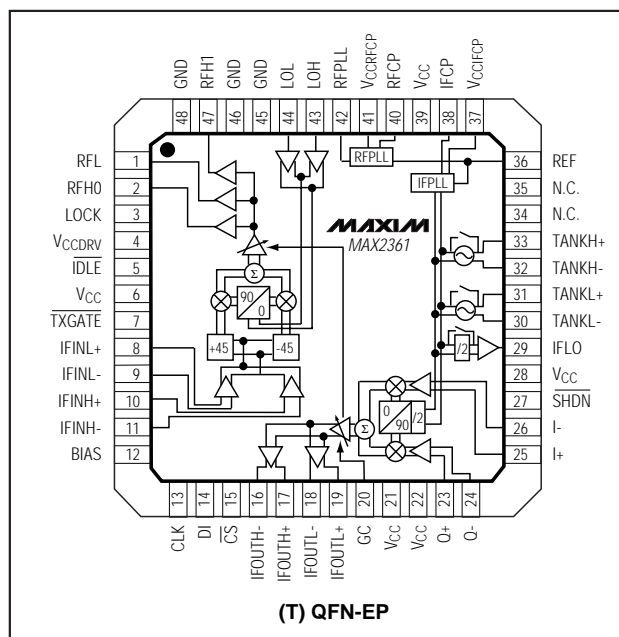

MAX2361/MAX2363/MAX2365



Complete Dual-Band Quadrature Transmitters

ABSOLUTE MAXIMUM RATINGS

V_{CC} to GND	-0.3V to +3.6V	Digital Input Current (\overline{SHDN} , \overline{TXGATE} , \overline{IDLE} , CLK, DI, \overline{CS})	± 10 mA
RFL, RFH0, RFH1,		Continuous Power Dissipation ($T_A = +70^\circ\text{C}$)	
V_{CCIFCP} , V_{CCRFCP} , V_{CCDRV} to GND	-0.3V to +5.5V	48-Pin QFN-EP (derate 27mW/ $^\circ\text{C}$ above $+70^\circ\text{C}$)	2.1W
DI, CLK, CS, GC, \overline{SHDN} , \overline{TXGATE} ,		Operating Temperature Range	-40°C to $+85^\circ\text{C}$
\overline{IDLE} , LOCK to GND	-0.3V to ($V_{CC} + 0.3$ V)	Junction Temperature	$+150^\circ\text{C}$
AC Input Pins (IFINL, IFINH, O, L, TANKL, TANKH,		Storage Temperature Range	-65°C to $+150^\circ\text{C}$
REF, RFPLL, LOL, LOH)	1.0V peak	Lead Temperature (soldering, 10s)	$+300^\circ\text{C}$

Stresses beyond those listed under "Absolute Maximum Ratings" may cause permanent damage to the device. These are stress ratings only, and functional operation of the device at these or any other conditions beyond those indicated in the operational sections of the specifications is not implied. Exposure to absolute maximum rating conditions for extended periods may affect device reliability.

DC ELECTRICAL CHARACTERISTICS

(MAX2361/MAX2363/MAX2365, $\overline{SHDN} = \overline{IDLE} = \overline{TXGATE} = \text{high}$, $V_{GC} = 2.4\text{V}$, $R_{BIAS} = 10\text{k}\Omega$, I_{CCCTRL} is in power-up state, no AC signals applied, $V_{CC} = +2.7\text{V}$ to $+3.3\text{V}$, $V_{BAT} = +2.7\text{V}$ to $+4.5\text{V}$, $T_A = -40^\circ\text{C}$ to $+85^\circ\text{C}$, unless otherwise noted. Typical values are at $V_{CC} = V_{BAT} = +2.8\text{V}$, $T_A = +25^\circ\text{C}$, and operating modes are defined in Table 9.)

PARAMETER	CONDITIONS	MIN	TYP	MAX	UNITS	
Operating Supply Voltage	V_{CC}	2.7		3.3	V	
	V_{BAT}	2.7		4.5		
Operating Supply Current	PCS mode	$V_{GC} = 0.6\text{V}$		50	82	mA
		$V_{GC} = 1.95\text{V}$		55	90	
		MPL = 0	$\text{PRFH0} = +5\text{dBm}$	114		
			$\text{PRFH1} = +5\text{dBm}$	121		
		MPL = 1	$\text{PRFH0} = +8\text{dBm}$	137		
			$\text{PRFH1} = +8\text{dBm}$	146		
	Cellular mode	$V_{GC} = 0.6\text{V}$		48	78	
		$V_{GC} = 1.95\text{V}$		53	86	
		MPL = 0, $\text{PRFL} = +5\text{dBm}$		102		
		MPL = 1, $\text{PRFL} = +8\text{dBm}$		126		
	FM mode	$V_{GC} = 1.95\text{V}$		75	85	
		MPL = 1, $\text{PRFL} = +11\text{dBm}$		87		
	Addition for IFLO buffer			3.4	7.7	
	$\overline{IDLE} = \text{low}$, PSS = 0			6	10	
$\overline{IDLE} = \text{low}$, PSS = 1			7.2	12.2		
$\overline{TXGATE} = \text{low}$, RFPLL off			11	17		
Leakage Current	$\overline{SHDN} = \text{low}$, RFH, RFL, V_{CCDRV}		0.5	20	μA	
Logic High		$0.7V_{CC}$			V	
Logic Low			$0.3V_{CC}$		V	
Logic Input Current		-5		+5	μA	
GC Input Current			6	11	μA	
GC Input Resistance During Shutdown	$\overline{SHDN} = \text{low}$	215	340		$\text{k}\Omega$	
Lock Indicator High	100k Ω pullup load	$V_{CC} - 0.4$			V	
Lock Indicator Low	100k Ω pullup load			1.0	V	

Complete Dual-Band Quadrature Transmitters

ELECTRICAL CHARACTERISTICS

(MAX2361/MAX2363/MAX2365 EV kit, 50Ω system, operating modes as defined in Table 9, TEMP_COMP = 10, input voltage at I and Q = 600mV_{p,p} differential, 300kHz quadrature CW tones, RF and IF synthesizers locked, V_{REF} = 200mV_{p,p} at 19.68MHz, V_{CC} = V_{BAT} = SHDN = IDLE = CS = TXGATE = 2.8V, LOH, LOL input power = -10dBm, f_{LOL} = 966.38MHz, f_{LOH} = 1750MHz, f_{RFH0} = f_{RFH1} = 1880.38MHz, f_{RFL} = 836MHz, T_A = +25°C, unless otherwise noted.)

PARAMETER	CONDITIONS	MIN	TYP	MAX	UNITS
MODULATOR, QUADRATURE MODES (CDMA, PCS, FM _{IQ})					
IF Frequency Range	IF_SEL = 0	120–235			MHz
	IF_SEL = 1	120–380			
I/Q Common-Mode Input Voltage	V _{CC} = +2.7V to +3.3V (Notes 1, 2, 3)	1.35	V _{CC} / 2	V _{CC} - 1.25	V
I/Q Input Current	Common-mode voltage = 1.4V	6			μA
IF Gain-Control Range	V _{GC} = 0.6V to 2.4V, IFG = 100	85			dB
IF Output Power at IFOUTL and IFOUTH	IFG = 100, ACPR = -60dBc (Note 4)	-7			dBm
Gain Variation Over Temperature	Relative to +25°C, T _A = -40°C to +85°C (Note 1)	-1	+1		dB
Carrier Suppression	V _{GC} = 2.4V, IFG = 100, f _{IFOUTL} = 130.38MHz (Note 1)	35	43		dB
Sideband Suppression	V _{GC} = 2.4V, IFG = 100, f _{IFOUTL} = 130.38MHz (Note 1)	35	45		dB
IF Output Noise	V _{GC} = 2.4V, noise measured at 20MHz offset	-143			dBm/Hz
MODULATOR, FM MODE					
Output Power at IFOUTL	V _{GC} = 2.4V, IFG = 100, I/Q modulation	-9			dBm
	V _{GC} = 2.4V, IFG = 100, direct VCO modulation	-4			
UPCONVERTER AND PREDRIVER					
IF Frequency Range	IF_SEL = 0	120–235			MHz
	IF_SEL = 1	180–380			
RFL Frequency Range	RFL port	800–1000			MHz
RFH_ Frequency Range	RFH0 and RFH1 ports	1700–2000			MHz
LOL Frequency Range		800–1150			MHz
LOH Frequency Range		800–2360			MHz
LO Input Power	LOL, LOH	-10	-7		dBm
RFPLL Frequency Range	PSS = 0	1300			MHz
	PSS = 1	2360			
Conversion Gain	MPL = 0, T _A = -40°C to +85°C	RFL	19.2		dB
		RFH0	18.9		
		RFH1	17.6		
	MPL = 1, T _A = -40°C to +85°C	RFL	22.4		
		RFH0	22.8		
		RFH1	21.4		
RF Gain-Control Range	V _{GC} = 0.6V to 2.4V	40			dB
Image Signal	At maximum output power	-35			dBc

MAX2361/MAX2363/MAX2365

Complete Dual-Band Quadrature Transmitters

ELECTRICAL CHARACTERISTICS (continued)

(MAX2361/MAX2363/MAX2365 EV kit, 50Ω system, operating modes as defined in Table 9, TEMP_COMP = 10, input voltage at I and Q = 600mV_{p,p} differential, 300kHz quadrature CW tones, RF and IF synthesizers locked, V_{REF} = 200mV_{p,p} at 19.68MHz, V_{CC} = V_{BAT} = SHDN = IDLE = CS = TXGATE = 2.8V, LOH, LOL input power = -10dBm, f_{LOL} = 966.38MHz, f_{LOH} = 1750MHz, f_{RFH0} = f_{RFH1} = 1880.38MHz, f_{RFL} = 836MHz, T_A = +25°C, unless otherwise noted.)

PARAMETER	CONDITIONS		MIN	TYP	MAX	UNITS
CASCADED MODULATOR, UPCONVERTER, AND PREDRIVER						
RFL Output Power	MPL = 1, T _A = -40°C to +85°C, meets ACPR specifications (Note 1)		6.8	9		dBm
RFH0 Output Power	MPL = 1, T _A = -40°C to +85°C, meets ACPR specifications (Note 1)		7.7	10.7		dBm
RFH1 Output Power	MPL = 1, T _A = -40°C to +85°C, meets ACPR specifications (Note 1)		6.6	9.7		dBm
RFL Adjacent Channel Power Ratio	f _{OFFSET} = ±885kHz in 30kHz bandwidth				-52	dBc
RFL Alternate Channel Power Ratio	f _{OFFSET} = ±1.98MHz in 30kHz bandwidth				-65	dBc
RFH_ Adjacent Channel Power Ratio	f _{OFFSET} = ±1.25MHz in 30kHz bandwidth				-52	dBc
RFH_ Alternate Channel Power Ratio	f _{OFFSET} = ±1.98MHz in 30kHz bandwidth				-68	dBc
RX Band Noise Power (Note 1)	MPL = 1, P _{RFL} = +8dBm	Noise measured at +45MHz offset		-131	-128	dBm/Hz
	MPL = 0, P _{RFL} = +5dBm			-134	-131	
	MPL = 1, P _{RFH_} = +8dBm	Noise measured at +80MHz offset		-131	-128	
	MPL = 0, P _{RFH_} = +5dBm			-133	-130	
Output Power Variation Over Temperature	Relative to +25°C, T _A = -40°C to +85°C			±1		dB
IF_PLL						
Reference Frequency			5		30	MHz
Reference Frequency Signal Level			0.1		0.6	V _{p,p}
IF Main Divide Ratio			256		16383	
IF Reference Divide Ratio			2		2047	
VCO Operating Range	VCO_SEL = 0		240–470			MHz
	VCO_SEL = 1		240–760			
Charge-Pump Source/Sink Current	ICP = 00		114	139	178	μA
	ICP = 01		158	192	246	
	ICP = 10		228	278	356	
	ICP = 11		319	390	499	

MAX2361/MAX2363/MAX2365

Complete Dual-Band Quadrature Transmitters

ELECTRICAL CHARACTERISTICS (continued)

(MAX2361/MAX2363/MAX2365 EV kit, 50Ω system, operating modes as defined in Table 9, TEMP_COMP = 10, input voltage at I and Q = 600mV_{p-p} differential, 300kHz quadrature CW tones, RF and IF synthesizers locked, V_{REF} = 200mV_{p-p} at 19.68MHz, V_{CC} = V_{BAT} = SHDN = IDLE = CS = TXGATE = 2.8V, LOH, LOL input power = -10dBm, f_{LOL} = 966.38MHz, f_{LOH} = 1750MHz, f_{RFHO} = f_{RFHI} = 1880.38MHz, f_{RFL} = 836MHz, T_A = +25°C, unless otherwise noted.)

PARAMETER	CONDITIONS	MIN	TYP	MAX	UNITS
TurboLock Boost Current	ICP_MAX = 1	632	774	987	μA
Charge-Pump Source/Sink Matching	All values of ICP, over specified compliance range			6	%
IF Charge-Pump Compliance		0.5		V _{CCIFCP} - 0.5	V
Charge-Pump High-Z Leakage	Over specified compliance range		20		pA
RF_PLL					
Reference Frequency		5		30	MHz
RF Main Divide Ratio		4096		262143	
RF Reference Divide Ratio		2		8191	
Charge-Pump Source/Sink Current	RCP = 00	266	325	416	μA
	RCP = 01	533	650	832	
	RCP = 10	605	738	945	
	RCP = 11	872	1063	1361	
TurboLock Boost Current	(Note 5)	1388	1694	2168	μA
Charge-Pump Source/Sink Matching	All values of RCP, over specified compliance range			6	%
RF Charge Pump Compliance		0.5		V _{CCRFCP} - 0.5	V
Phase Detector Noise Floor	RCP = 11, RCP_TURBO1 = RCP_TURBO2 = 0, 30kHz comparison frequency		-162		dBc/Hz
Charge-Pump High-Z Leakage	Over specified compliance range		20		pA
RFPLL Input Sensitivity		160			MV _{p-p}

Note 1: Guaranteed by design and characterization to 3 sigma (includes board and component variations).

Note 2: ACPR is met over the specified V_{CM} range.

Note 3: V_{CM} must be supplied by the I/Q baseband source with ±8μA capability.

Note 4: IQ_LEVEL = 0, V_{O-} = V_{I-} = 87mV_{RMS} differential, IS98 reverse channel modulation at 415mV_{p-p} differential with 0.1% 4.5dB peak-to-average ratio.

Note 5: When enabled with RCP_TURBO1 and RCP_TURBO2 (see Tables 2 and 3), the total charge-pump current is specified. For all values of RCP, the total turboLock current is 1.63 times the corresponding nonturbo current value.

MAX2361/MAX2363/MAX2365

Complete Dual-Band Quadrature Transmitters

Typical Operating Characteristics

(MAX2361 EV kit, $V_{CC} = V_{BAT} = +2.8V$, $T_A = +25^\circ C$, unless otherwise noted.)

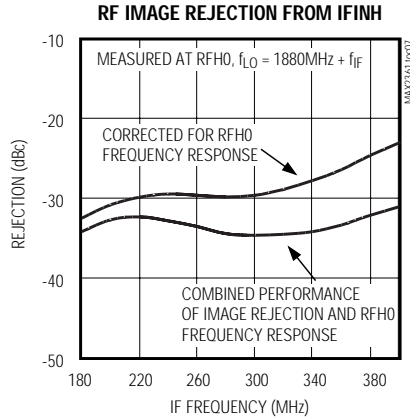
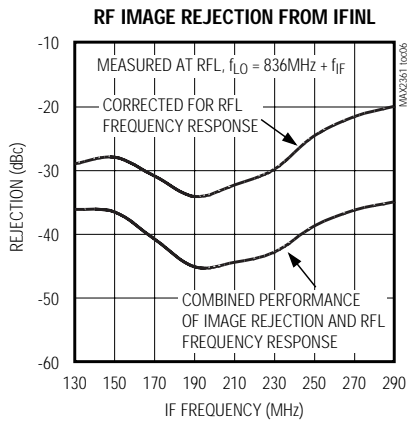
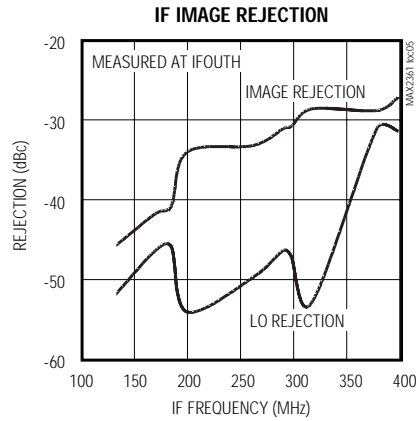
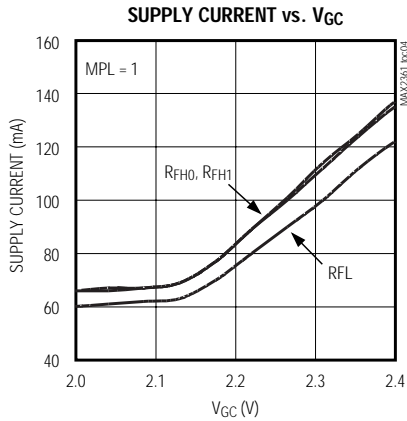
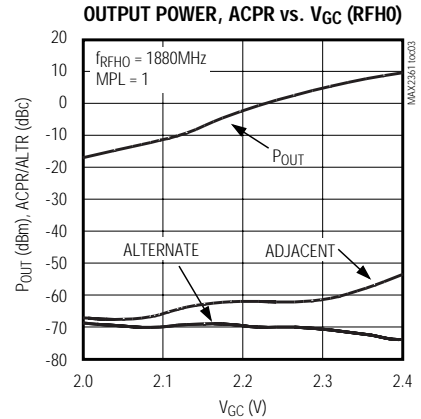
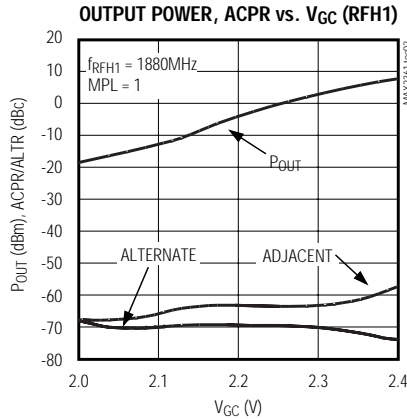
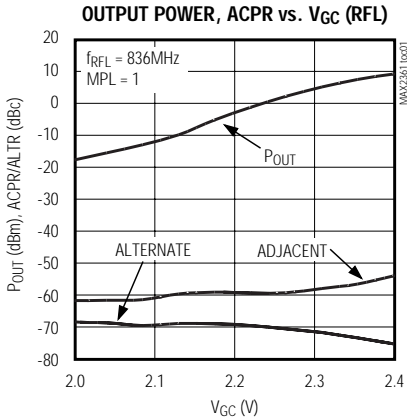

Complete Dual-Band Quadrature Transmitters

Typical Operating Characteristics (continued)

(MAX2361 EV kit, $V_{CC} = V_{BAT} = +2.8V$, $T_A = +25^\circ C$, unless otherwise noted.)

MAX2361/MAX2363/MAX2365

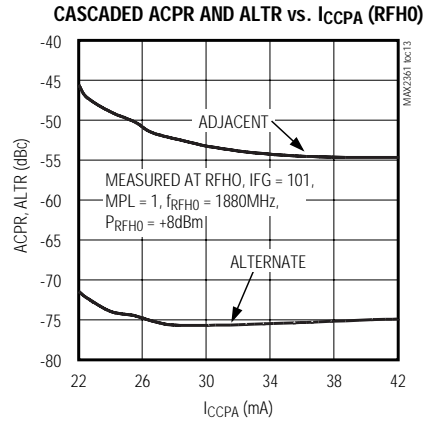
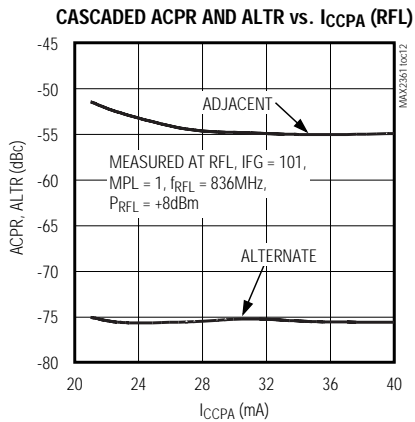
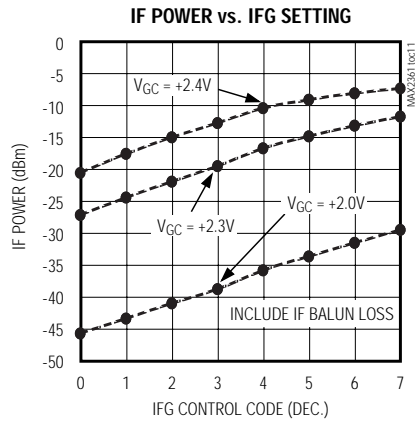
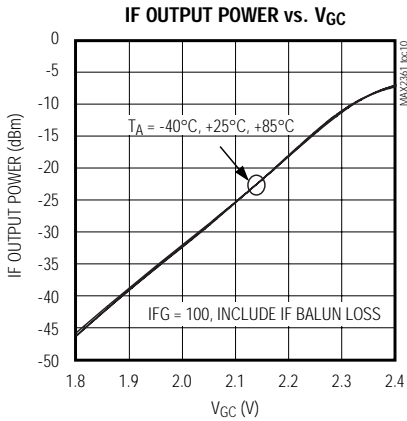
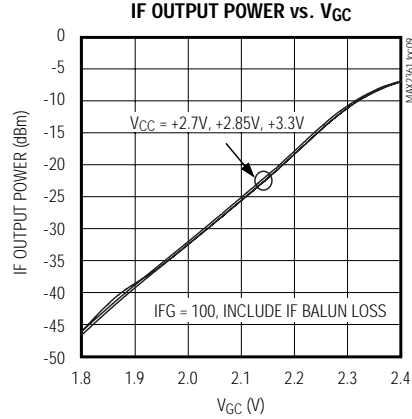
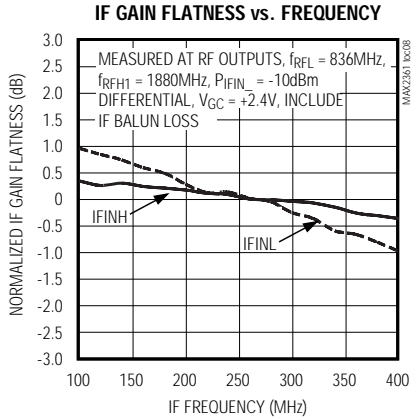

Complete Dual-Band Quadrature Transmitters

Typical Operating Characteristics (continued)

(MAX2361 EV kit, $V_{CC} = V_{BAT} = +2.8V$, $T_A = +25^\circ C$, unless otherwise noted.)

MAX2361/MAX2363/MAX2365

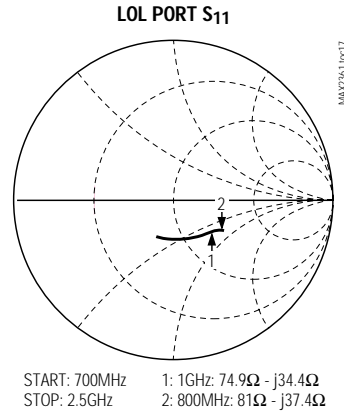
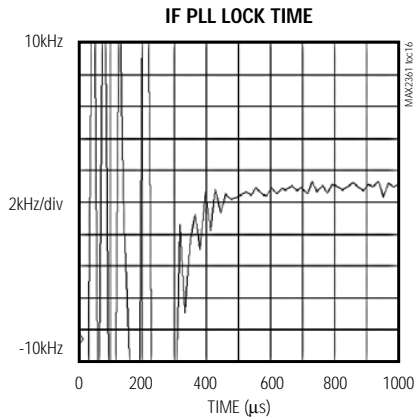
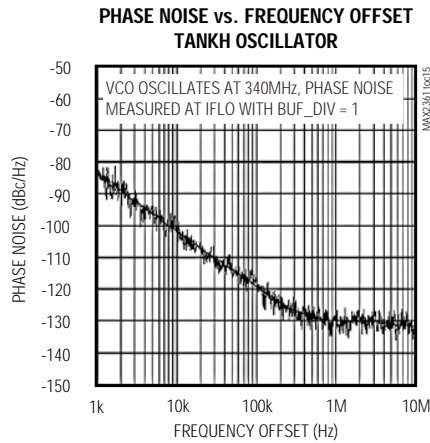
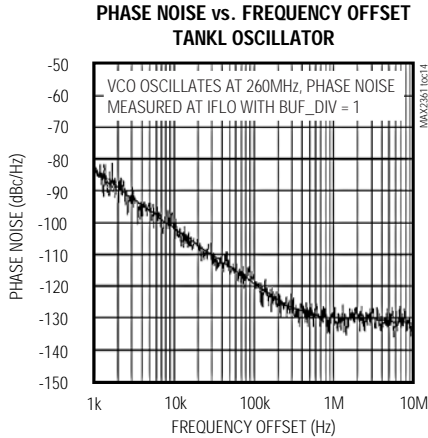

ICP = 11, ICP_MAX = 0
 $f_{COMP} = 240kHz$, $f_{IF} = 263.64MHz$
 LOOP FILTER: $20k\Omega$ IN SERIES WITH $2.2nF$, $220pF$ PARALLEL
 LOOP BW = $10kHz$

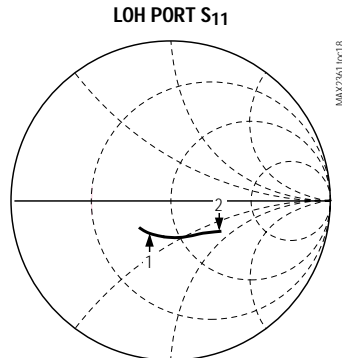

START: 700MHz STOP: 2.5GHz
 1: 2.36GHz: $37.2\Omega - j16.8\Omega$
 2: 800MHz: $80\Omega - j38.9\Omega$

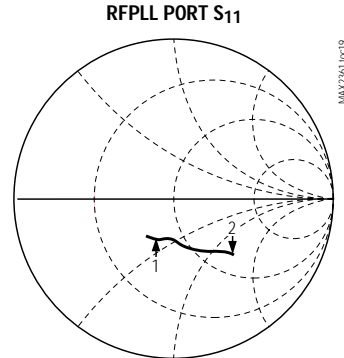

START: 700MHz STOP: 2.5GHz
 1: 2.36GHz: $38.3\Omega - j20.2\Omega$
 2: 800MHz: $70.4\Omega - j61.6\Omega$

Complete Dual-Band Quadrature Transmitters

Pin Description

PIN			NAME	FUNCTION
MAX2361	MAX2363	MAX2365		
1	—	1	RFL	Transmitter RF Output for Cellular Band (800MHz to 1000MHz)—for both FM and digital modes. This open-collector output requires a pullup inductor to the supply voltage, which may be part of the output matching network and can be connected directly to the battery.
2	2	—	RFH0	Transmitter RF Output for PCS Band (1700MHz to 2000MHz). This open-collector output requires a pullup inductor to the supply voltage. The pullup inductor may be part of the output matching network and may be connected directly to the battery. For split band PCS application, use RFH0 for the 1880MHz–1910MHz range.
3	3	3	LOCK	Open-Collector Output Indicating Lock Status of the IF and/or the RF PLLs. Requires a pullup resistor. Control using configuration register bits LD_MODE.
4	4	4	VCCDRV	Supply Pin for the Driver Stage. May be connected directly to the battery. Bypass to PC board ground as close to the pin as possible. The ground vias for the bypass capacitor should not be shared by any other branch.
5	5	5	$\overline{\text{IDLE}}$	Digital Input, Drive to Logic High for Normal Operation. A logic low on $\overline{\text{IDLE}}$ shuts down everything except the RF PLL and associated registers. A small R-C lowpass can be used to filter digital noise.
6	6	6	VCC	Supply Pin for the Upconverter Stage. VCC must be bypassed to system ground as close to the pin as possible. The ground vias for the bypass capacitor should not be shared by any other branch.
7	7	7	$\overline{\text{TXGATE}}$	Digital Input, Drive to Logic High for Normal Operation. A logic low on $\overline{\text{TXGATE}}$ shuts down everything except the RF PLL, IF PLL, IF VCO, and serial bus and registers. This mode is used for gated transmission.
8, 9	—	8, 9	IFINL+, IFINL-	Differential Inputs to the RF Upconverter. These pins are internally biased. The input impedance for these ports is nominally 400 Ω differential. The IF filter should be AC-coupled to these ports. Keep the differential lines as short as possible to minimize stray pickup and shunt capacitance.
10, 11	10, 11	—	IFINH+, IFINH-	Differential Inputs to the RF Upconverter. These pins are internally biased. The input impedance for these ports is nominally 400 Ω differential. The IF filter should be AC-coupled to these ports. Keep the differential lines as short as possible to minimize stray pickup and shunt capacitance.
12	12	12	BIAS	Bias Resistor Pin. BIAS is internally biased to approximately 600mV. An external resistor between this pin to GND sets the bias current for the upconverters and PA driver stages. The nominal resistor value is 10k Ω . This value can be altered to optimize the linearity of the driver stage.
13, 14, 15	13, 14, 15	13, 14, 15	CLK, DI, $\overline{\text{CS}}$	Input Pins from the 3-Wire Serial Bus (SPI/QSPI/MICROWIRE compatible)

MAX2361/MAX2363/MAX2365

Complete Dual-Band Quadrature Transmitters

Pin Description (continued)

PIN			NAME	FUNCTION
MAX2361	MAX2363	MAX2365		
16, 17	16, 17	—	IFOUTH-, IFOUTH+	Differential IF Outputs. These ports are active when the register bit IF_SEL is 1. They do not support FM mode. These pins must be inductively pulled up to V _{CC} . A differential IF bandpass filter is connected between this port and IFINH+ or IFINH-. The pullup inductors can be part of the filter structure. The differential output impedance of this port is nominally 600Ω. The transmission lines from these pins should be short to minimize the pickup of spurious signals and noise.
18, 19	—	18, 19	IFOUTL-, IFOUTL+	Differential IF Outputs. These ports are active when the register bit IF_SEL is 0. These pins must be inductively pulled up to V _{CC} . A differential IF bandpass filter is connected between this port and IFINL+ and IFINL-. The pullup inductors can be part of the filter structure. The differential output impedance of this port is nominally 600Ω. The transmission lines from these pins should be short to minimize the pickup of spurious signals and noise.
20	20	20	GC	RF and IF Gain Control Analog Input. Apply 0.6V to 2.4V to control the gain of the RF and IF stages. An RC filter on this pin should be used to reduce DAC noise or PDM clock spurs from this line.
21	21	21	V _{CC}	Supply Pin for the IF VGA. Bypass with a capacitor as close to the pin as possible. The bypass capacitor must not share its ground vias with any other branches.
22	22	22	V _{CC}	Supply for the I/Q Modulator. Bypass with a capacitor as close to the pin as possible. The bypass capacitor must not share its ground vias with any other branches.
23, 24	23, 24	23, 24	Q+, Q-	Differential Q-Channel Baseband Inputs to the Modulator. These pins go directly to the bases of a differential pair and require an external common-mode bias voltage.
25, 26	25, 26	25, 26	I+, I-	Differential I-Channel Baseband Inputs to the Modulator. These pins go directly to the bases of a differential pair and require an external common-mode bias voltage.
27	27	27	$\overline{\text{SHDN}}$	Shutdown Input, Drive to Logic High for Normal Operation. A logic low on $\overline{\text{SHDN}}$ shuts down the entire IC except the serial interface and retains the information in all registers. An R-C lowpass can be used to filter digital noise.
28	28	28	V _{CC}	Supply Pin to the VCO Section. Bypass as close to the pin as possible. The bypass capacitor should not share its vias with any other branches.
29	29	29	IFLO	Buffered LO Output. Control the output buffer using register bit BUF_EN and the divide ratio using the register bit BUF_DIV.
30, 31	—	30, 31	TANKL-, TANKL+	Differential Tank Pins for the Low-Frequency IF VCO. These pins are internally biased. VCO_SEL = 0 selects this IF VCO.

MAX2361/MAX2363/MAX2365

Complete Dual-Band Quadrature Transmitters

Pin Description (continued)

PIN			NAME	FUNCTION
MAX2361	MAX2363	MAX2365		
32, 33	32, 33	—	TANKH-, TANKH+	Differential Tank Pins for the High-Frequency IF VCO. These pins are internally biased. VCO_SEL = 1 selects this IF VCO.
34, 35	1, 8, 9, 18, 19, 30, 31, 34, 35, 44	2, 10, 11, 16, 17, 32–35, 43, 47	N.C.	No Connection. Make no connection to these pins.
36	36	36	REF	Reference Frequency Input. REF is internally biased and must be AC-coupled to the reference source. This is a high-impedance port (25kΩ 3pF).
37	37	37	VCCIFCP	Supply for the IF Charge Pump. This supply can differ from the system V _{CC} . Bypass as close to the pin as possible. The bypass capacitor must not share its vias with any other branches.
38	38	38	IFCP	High-Impedance Output of the IF Charge Pump. Connect to the tune input of the IF VCOs through the IF PLL loop filter. Keep the line from IFCP to the tune input as short as possible to prevent spurious pick-up, and connect the loop filter as close to the tune input as possible.
39	39	39	V _{CC}	Supply Pin for Digital Circuitry. Bypass as close to the pin as possible. The bypass capacitor must not share its vias with any other branch.
40	40	40	RFCP	High-Impedance Output of the RF Charge Pump. Connect to the tune input of the RF VCOs through the RF PLL loop filter. Keep the line from this pin to the tune input as short as possible to prevent spurious pickup, and connect the loop filter as close to the tune input as possible.
41	41	41	V _{CCRFCP}	Supply for the RF Charge Pump. This supply can differ from the system V _{CC} . Bypass as close to the pin as possible. The bypass capacitor must not share its vias with any other branches.
42	42	42	RFPLL	RF PLL Input. AC-couple this port to the RF VCO. RFPLL is internally biased.
43	43	—	LOH	High-band RF LO Input Port. AC-couple to this port.
44	—	44	LOL	Low-band RF LO Input Port. AC-couple to this port.
45, 46, 48	45, 46, 48	45, 46, 48	GND	Isolation GND. No internal connection. Connect to PC board ground plane for better isolation.
47	47	—	RFH1	Transmitter RF Output for PCS Band (1700MHz to 2000MHz). This open-collector output requires a pullup inductor to the supply voltage. The pullup inductor may be part of the output matching network and can be connected directly to the battery. For split band PCS application, use RFH1 for the 1850MHz–1880MHz range.
EP	EP	EP	GND	DC and AC GND Return for the IC. Connect to PC board ground plane using multiple vias.

MAX2361/MAX2363/MAX2365

Complete Dual-Band Quadrature Transmitters

Detailed Description

The MAX2361 complete quadrature transmitter accepts differential I/Q baseband inputs with external common-mode bias. A modulator upconverts this to IF frequency in the 120MHz to 380MHz range. A gain-control voltage pin (GC) controls the gain of both the IF and RF VGAs simultaneously to achieve the best current consumption and linearity performance. The IF signal is brought off-chip for filtering, then fed to a single sideband upconverter followed by the RF VGA and PA driver. The RF upconverter requires an external VCO for operation. The IF PLL, RF PLL, and operating mode can be programmed by an SPI/QSPI/MICROWIRE-compatible 3-wire interface.

The following sections describe each block in the MAX2361 *Functional Diagram*.

I/Q Modulator

Differential in-phase (I) and quadrature-phase (Q) input pins are designed to be DC-coupled and biased with the baseband output from a digital-to-analog converter (DAC). I and Q inputs need a DC bias of $V_{CC}/2$ and a current-drive capability of 8 μ A. The I and Q inputs capacitance is typically 0.3pF differential. Common-mode voltage works within a 1.35V to ($V_{CC} - 1.25V$) range. The IF VCO output is fed into a divide-by-two/quadrature generator block to derive quadrature LO components to drive the IQ modulator. The output of the modulator is fed into the VGA.

IF VCOs

There are two VCOs to support high IF and low IF frequencies. The VCOs oscillate at twice the desired IF frequency. Oscillation frequency is determined by external tank components (see *Applications Information*). Typical phase-noise performance for the tank is as shown in the *Typical Operating Characteristics*. The high-band and low-band VCOs can be selected independently of the IF port being used.

IFLO Output Buffer

IFLO provides a buffered LO output when BUF_EN is 1. The IFLO output frequency is equal to the VCO frequency when BUF_DIV is 0, and half the VCO frequency when BUF_DIV is 1. The output power is -12dBm. This output is intended for applications where the receive IF is the same frequency as the transmit IF.

IF/RF PLL

The IF/RF PLL uses a charge-pump output to drive a loop filter. The loop filter typically is passive second-order lead lag filter. Outside the filter's bandwidth, phase noise is determined by the tank components. The two components that contribute most significantly to phase noise are the inductor and varactor. Use high-Q inductors and varactors to maximize equivalent parallel resistance. The IF_TURBO_CHARGE, RCP_TURBO1, and RCP_TURBO2 bits can be set to enable turbo mode. Turbo mode provides maximum charge-pump current during frequency acquisition. Turbo mode is disabled after frequency acquisition is achieved. When turbo mode is disabled, charge-pump current returns to the programmed levels as set by ICP and RCP bits in the CONFIG register (Table 3).

The PSS bit selects the RFPLL prescaler speed independent of the MODE bits. This enables PCS band VCO locking when transmitting in the cellular band. For VCO frequency above 1300MHz, set PSS to 1.

IF VGA

The IF VGA allows varying an IF output level that is controlled by GC voltage. The voltage range on GC of 0.6V to 2.4V provides a gain-control range of 85dB. There are two differential IF output ports from the VGA. IFOUTL+/IFOUTL- are optimized for low IF operation (120MHz to 235MHz); IFOUTH+/IFOUTH- support high IF operation (120MHz to 380MHz). IFOUTL supports FM mode by providing higher IF output level when MODE is set to 00.

Single Sideband Mixer

The RF transmit mixer uses a single sideband architecture to eliminate an off-chip RF filter. The single sideband mixer has IF input stages that correspond to IF output ports of the VGA. The mixer is followed by the RF VGA. The RF VGA is controlled by the same GC pin as the IF VGA to provide optimum current consumption and linearity performance. The total power-control range is >100dB.

PA Driver

The MAX2361 includes three power-amplifier (PA) drivers. Each is optimized for the desired operating frequency. RFL is optimized for cellular-band operation. RFH0 and RFH1 are optimized for split-band PCS operation. Use RFH0 in single high-band output such as TDMA or W-CDMA. The PA drivers have open-collector outputs and require pullup inductors. The pullup inductors can act as the shunt element in a shunt series match.

Complete Dual-Band Quadrature Transmitters

MAX2361/MAX2363/MAX2365

Programmable Registers

The MAX2361/MAX2363/MAX2365 include eight programmable registers consisting of four divide registers, a configuration register, an operational control register, a current control register, and a test register. Each register consists of 24 bits. The 4 least significant bits (LSBs) are the register's address. The 20 most significant bits (MSBs) are used for register data. All registers contain some "don't care" bits. These can be either a "0" or a "1" and will not affect operation (Figure 1). Data is shifted in MSB first, followed by the 4-bit address. When \overline{CS} is low, the clock is active and data is shifted with the rising edge of the clock. When \overline{CS} transitions to high, the shift register is latched into the register selected by the contents of the address bits. Power-up defaults for the eight registers are shown in Table 1. The dividers and control registers are programmed from the SPI/QSPI/MICROWIRE-compatible serial port.

The RFM register sets the main frequency divide ratio for the RF PLL. The RFR register sets the reference frequency divide ratio. The RF VCO frequency can be determined by the following:

$$\text{RF VCO frequency} = f_{\text{REF}} \times (\text{RFM} / \text{RFR})$$

IFM and IFR registers are similar:

$$\text{IF VCO frequency} = f_{\text{REF}} \times (\text{IFM} / \text{IFR})$$

where f_{REF} is the external reference frequency.

The operational control register (OPCTRL) controls the state of the MAX2361/MAX2363/MAX2365. See Table 2 for the function of each bit.

The configuration register (CONFIG) sets the configuration for the RF/IF PLL and the baseband I/Q input levels. See Table 3 for a description of each bit.

The current control register modifies the bias current to accommodate different operation modes. In the high-power mode, $\text{MPL} = 1$ sets the bias current and conversion gain to deliver a minimum of +8dBm output

power from the PA drivers. In the low-power mode, $\text{MPL} = 0$ sets the bias current and conversion gain to deliver a minimum of +5dBm output power from the PA drivers. I_MULT sets the current multiplication factor for the PA driver stages according to Table 5. THROTTLE_BACK sets the rate of bias current changes when the output power changes according to Table 6. For example, when $\text{THROTTLE_BACK} = 011$ (default), the PA driver bias current reduces by 1dBmA for every 1dB reduction in output power. $\text{THROTTLE_BACK} = 000$ setting gives a more aggressive current reduction (1.3dBmA/dB power) at the expense of linearity. THROTTLE_BACK setting does not affect the bias current at maximum power level.

The test register has to be 100hex for normal operation. The best way to ensure this is to program the test register to 100hex.

Power Management

Bias control is distributed among several functional sections and can be controlled to accommodate many different power-down modes as shown in Table 8.

The serial interface remains active during shutdown. Setting $\text{SHDN_BIT} = 0$ or $\text{SHDN} = \text{GND}$ powers down the device. In either case, PLL programming and register information is retained.

Signal Flow Control

Table 9 shows an example of key registers for triple-mode operation, assuming half-band PCS and IF frequencies of 228.6MHz/263.6MHz.

Applications Information

The MAX2361 is designed for use in dual-band, triple-mode systems. It is recommended for triple-mode handsets (Figure 2). The MAX2363 is designed for use in CDMA PCS handset or W-CDMA systems (Figure 3). The MAX2365 is designed for use in dual-mode cellular systems (Figure 4).

Table 1. Register Power-Up Default States

REGISTER	DEFAULT	ADDRESS	FUNCTION
RFM	32214 dec	0000 _b	RF M divider count
RFR	656 dec	0001 _b	RF R divider count
IFM	6519 dec	0010 _b	IF M divider count
IFR	0492 dec	0011 _b	IF R divider count
OPCTRL	090F hex	0100 _b	Operational control settings
CONFIG	D03F hex	0101 _b	Configuration and setup control
I _{CC} CTRL	0038 hex	0110 _b	Current multiplication factor, PLL band
TEST	100 hex	0111 _b	Test-mode control

Complete Dual-Band Quadrature Transmitters

MAX2361/MAX2363/MAX2365

		24 BIT REGISTER																				ADDRESS			
		DATA 20 BITS																				ADDRESS 4 BITS			
		B19	B18	B17	B16	B15	B14	B13	B12	B11	B10	B9	B8	B7	B6	B5	B4	B3	B2	B1	B0	A3	A2	A1	A0
RFM DIVIDE REGISTER		RFM DIVIDE RATIO (18)																		ADDRESS					
		X	X		B17	B16	B15	B14	B13	B12	B11	B10	B9	B8	B7	B6	B5	B4	B3	B2	B1	B0	0	0	0
RFR DIVIDE REGISTER		RFR DIVIDE RATIO (13)													ADDRESS										
		X	X	X	X	X	X	X		B12	B11	B10	B9	B8	B7	B6	B5	B4	B3	B2	B1	B0	0	0	0
IFM DIVIDE REGISTER		IFM DIVIDE RATIO (14)														ADDRESS									
		X	X	X	X	X	X		B13	B12	B11	B10	B9	B8	B7	B6	B5	B4	B3	B2	B1	B0	0	0	1
IFR DIVIDE REGISTER		IFR DIVIDE RATIO (11)											ADDRESS												
		X	X	X	X	X	X	X	X		B10	B9	B8	B7	B6	B5	B4	B3	B2	B1	B0	0	0	1	1
CONTROL REGISTER		OPERATION CONTROL BITS (16)																ADDRESS							
		X	X	X	X		B15	B14	B13	B12	B11	B10	B9	B8	B7	B6	B5	B4	B3	B2	B1	B0	0	1	0
CONFIGURATION REGISTER		CONFIGURATION BITS (16)																ADDRESS							
		X	X	X	X		B15	B14	B13	B12	B11	B10	B9	B8	B7	B6	B5	B4	B3	B2	B1	B0	0	1	0
CURRENT CONTROL REGISTER		CURRENT CONTROL BITS (16)																ADDRESS							
		X	X	X	X		B15	B14	B13	B12	B11	B10	B9	B8	B7	B6	B5	B4	B3	B2	B1	B0	0	1	1
TEST REGISTER		TEST BITS (9)									ADDRESS														
		X	X	X	X	X	X	X	X	X		B8	B7	B6	B5	B4	B3	B2	B1	B0	0	1	1	1	

X = DONT CARE

Figure 1. Register Configuration

Cascaded Performance

Tables 11 and 12 show the typical cascaded performance for TDMA and W-CDMA systems.

3-Wire Interface

Figure 5 shows the 3-wire interface timing diagram. The 3-wire bus is SPI/QSPI/MICROWIRE compatible.

Electromagnetic Compliance Considerations

Two major concepts should be employed to produce a low-spur and EMC-compliant transmitter: minimize circular current-loop area to reduce H-field radiation. To minimize circular current-loop area, bypass as close to

the part as possible and use the distributed capacitance of a ground plane. To minimize voltage drops, make VCC traces short and wide, and make RF traces short.

Program only the necessary bits in any register to minimize clock cycles. RC filtering can also be used to slow the clock edges on the 3-wire interface, reducing high-frequency spectral content. RC filtering also provides for transient protection against IEC802 testing by shunting high frequencies to ground, while the series resistance attenuates the transients for error-free operation. The same applies to the logic input pins (SHDN, TXGATE, IDLE).

Complete Dual-Band Quadrature Transmitters

Table 2. Operation Control Register (OPCTRL)

BIT NAME	POWER-UP STATE	BIT LOCATION (0 = LSB)	FUNCTION
LO_SEL	0	15	0 selects LOL input port; 1 selects LOH port.
RCP_TURBO1	0	14	Works in conjunction with RCP_TURBO2 (CONFIG register) to set the turbo-charge pump mode. (See Table 7)
ICP_MAX	0	13	1 keeps IF turbo-mode current active even when frequency acquisition is achieved. This mode is used when high operating IF charge-pump current is needed.
MODE	01	12, 11	Sets operating mode according to the following: 00 = FM mode 01 = Cellular digital mode, RFL is selected 10 = Lower half-band PCS mode, RFH1 is selected 11 = Upper half-band PCS, RFH0 is selected
IF_SEL	0	10	1 selects IFINH and IFOUTH; 0 selects IFINL and IFOUTL. For FM mode (MODE = 00), set IF_SEL to 0.
VCO_SEL	0	9	1 selects high-band IF VCO; 0 selects low-band IF VCO.
IFG	100	8, 7, 6	3-Bit IF gain Control. Alters IF gain by approximately 2dB per LSB (0 to 14dB). Provides a means for adjusting balance between RF and IF gain for optimized linearity.
SIDE_BAND	0	5	When this bit is 1, the upper sideband is selected (LO below RF). When this bit is 0, the lower sideband is selected (LO above RF).
BUF_EN	0	4	0 turns IFLO buffer off; 1 turns IFLO buffer on.
MOD_TYPE	1	3	0 selects direct VCO modulation. (IF VCO is externally modulated and the I/Q modulator is bypassed); 1 selects quadrature modulation.
$\overline{\text{STBY}}$	1	2	0 shuts down everything except registers and serial interface.
$\overline{\text{TXSTBY}}$	1	1	0 shuts down modulator and upconverter, leaving PLLs locked and registers active. This is the programmable equivalent to the $\overline{\text{TXGATE}}$ pin.
SHDN_BIT	1	0	0 shuts down everything except serial interface, and also retains all register settings.

MAX2361/MAX2363/MAX2365

Complete Dual-Band Quadrature Transmitters

Table 3. Configuration Register (CONFIG)

BIT NAME	POWER-UP STATE	BIT LOCATION (0 = LSB)	FUNCTION
IF_PLL_SHDN	1	15	0 shuts down the IF PLL. This mode is used with an external IF PLL.
RF_PLL_SHDN	1	14	0 shuts down the RF PLL. This mode is used with an external RF PLL.
ZERO_BIAS	0	13	0 for normal operation, 1 turns off the bias current to RFH0 output driver.
IQ_LEVEL	1	12	1 selects 200mV _{RMS} input mode; 0 selects 100mV _{RMS} input mode.
BUF_DIV	0	11	1 selects +2 on IFLO port; 0 bypasses the divider.
VCO_BYPASS	0	10	1 bypasses IF VCO and enables a buffered input for external VCO use.
ICP	00	9, 8	A 2-bit register sets the IF charge-pump current as follows: 00 = 139μA 01 = 192μA 10 = 278μA 11 = 390μA
RCP	00	7, 6	A 2-bit register sets the RF charge-pump current as follows: 00 = 325μA 01 = 650μA 10 = 738μA 11 = 1063μA
IF_PD_POL	1	5	IF phase-detector polarity; 1 selects positive polarity (increasing tuning voltage on the VCO produces increasing frequency); 0 selects negative polarity (increasing tuning voltage on the VCO produces decreasing frequency).
RF_PD_POL	1	4	RF phase-detector polarity; 1 selects positive polarity (increasing tuning voltage on the VCO produces increasing frequency); 0 selects negative polarity (increasing voltage on the VCO produces decreasing frequency).
IF_TURBO_CHARGE	1	3	1 activates turbocharge feature, providing an additional IF charge-pump current during frequency acquisition.
RCP_TURBO2	1	2	Works in conjunction with RCP_TURBO1 (OPCTRL register) to set the turbocharge current mode. (See Table 7).
LD_MODE	11	1, 0	Determines output mode for LOCK detector pin as follows: 00 = test mode, LD_MODE cannot be 00 for normal operation 01 = IF PLL lock detector 10 = RF PLL lock detector 11 = logical AND of IF PLL and RF PLL lock detectors

MAX2361/MAX2363/MAX2365

Complete Dual-Band Quadrature Transmitters

MAX2361/MAX2363/MAX2365

Table 4. Current Control Register (IccCTRL)

BIT NAME	POWER-UP STATE	BIT LOCATION (0 = LSB)	FUNCTION
RESERVED	00	15, 14	Must be set to 00 for normal operation.
PSS	0	13	Prescaler speed select. 0 selects the lower frequency band RFPLL prescaler. 1 selects the higher frequency band prescaler.
RESERVED	0	12	Must be set to 0 for normal operation.
MPL	0	11	Sets the maximum output power level. 0 selects +6.5dBm, 1 selects +10dBm output power modes.
TEMP_COMP	00	10, 9	Sets current scale factor to compensate temperature variations. Set to 10 for best linearity over temperature.
RESERVED	0	8	Must be set to 0 for normal operation.
MOD_BYPASS	0	7	1 routes differential signal at pins 30 and 31 directly to the IF VGA and bypasses the IF modulator. This mode is used with external modulator.
THROTTLE_BACK	011	6, 5, 4	Throttle back rate (Table 6)
I_MULT	1000	3, 2, 1, 0	Sets current scale factor for PA drivers (Table 5)

Table 5. Current Scale Factors Set By I_MULT Bits

BIT NAME	BITS	CURRENT SCALE
I_MULT	0000	0.50
	0001	0.56
	0010	0.62
	0011	0.69
	0100	0.75
	0101	0.81
	0110	0.88
	0111	0.94
	1000 (default)	1.00
	1001	1.13
	1010	1.25
	1011	1.38
	1100	1.50
	1101	1.63
	1110	1.75
	1111	1.88

Table 6. Throttle-Back Rate Set By THROTTLE_BACK Bits

BIT NAME	BITS	RATE	UNIT
THROTTLE_BACK	000	1.3	dBm/dB
	001	1.2	
	010	1.1	
	011 (default)	1.0	
	100	0.9	
	101	0.8	
	110	0.7	
	111	0.6	

Complete Dual-Band Quadrature Transmitters

MAX2361/MAX2363/MAX2365

Table 7. RF Turbo Charge-Pump Current Setting

RCP_TURBO1	RCP_TURBO2	
0	0	No turbo current. Charge-pump current is set by RCP bits.
0	1	Turbo current turns on every time RFPLL is reprogrammed. Turbo current is automatically turned off after RFPLL is locked.
1	0	Turbo current is always on.
1	1	Turbo current is turned on every time RFPLL is out of lock.

Table 8. Power-Down Modes

POWER-DOWN MODE	COMMENTS	UPCONVERTER	MODULATOR	RF_PLL	IF_VCO	IF_PLL
SHDN Pin	Ultra-low shutdown current	X	X	X	X	X
IDLE Pin	RX only mode	X	X		X	X
TXGATE Pin	For punctured TX mode	X	X			
RF PLL SHDN	For external RF PLL use			X		
IF PLL SHDN	For external IF PLL use					X
TXSTBY Bit	TX is OFF, but IF and RF LOs stay locked	X	X			

X = Off

Complete Dual-Band Quadrature Transmitters

Table 9. Register and Control Pin States for Key Operating Modes

MODE	DESCRIPTION	OPCTRL REGISTER							CONFIG REGISTER		CONTROL PINS			
		LO_SEL	MODE	IF_SEL	VCO_SEL	MOD_TYPE	STBY	TXSTBY	SHDN_BIT	IF_PLL_SHDN	RF_PLL_SHDN	IDLE	TXGATE	SHDN
PCS High	PCS upper half-band, RFH0 selected	1	11	1	1	1	1	1	1	1	1	H	H	H
PCS Low	PCS lower half-band, RFH1 selected	1	10	1	1	1	1	1	1	1	1	H	H	H
Cellular Digital	RFL selected	0	01	0	0	1	1	1	1	1	1	H	H	H
FM	Direct VCO modulation, RFL selected	0	00	0	0	0	1	1	1	1	1	H	H	H
PCS Idle	Listen for pages RX ON, TX OFF	1	1X	1	1	1	1	X	1	X	1	L	H	H
Cellular Idle	Listen for pages RX ON, TX OFF	0	0X	0	0	X	1	X	1	X	1	L	H	H
PCS TXGATE	Gated transmission, PCS	1	1X	1	1	1	1	X	1	1	1	H	L	H
Cellular TXGATE	Gated transmission, cellular digital	0	01	0	0	1	1	X	1	1	1	H	L	H
Sleep	Ultra-Low Current	X	XX	X	X	X	X	X	X	X	X	X	X	L

X = Don't care

MAX2361/MAX2363/MAX2365

Complete Dual-Band Quadrature Transmitters

MAX2361/MAX2363/MAX2365

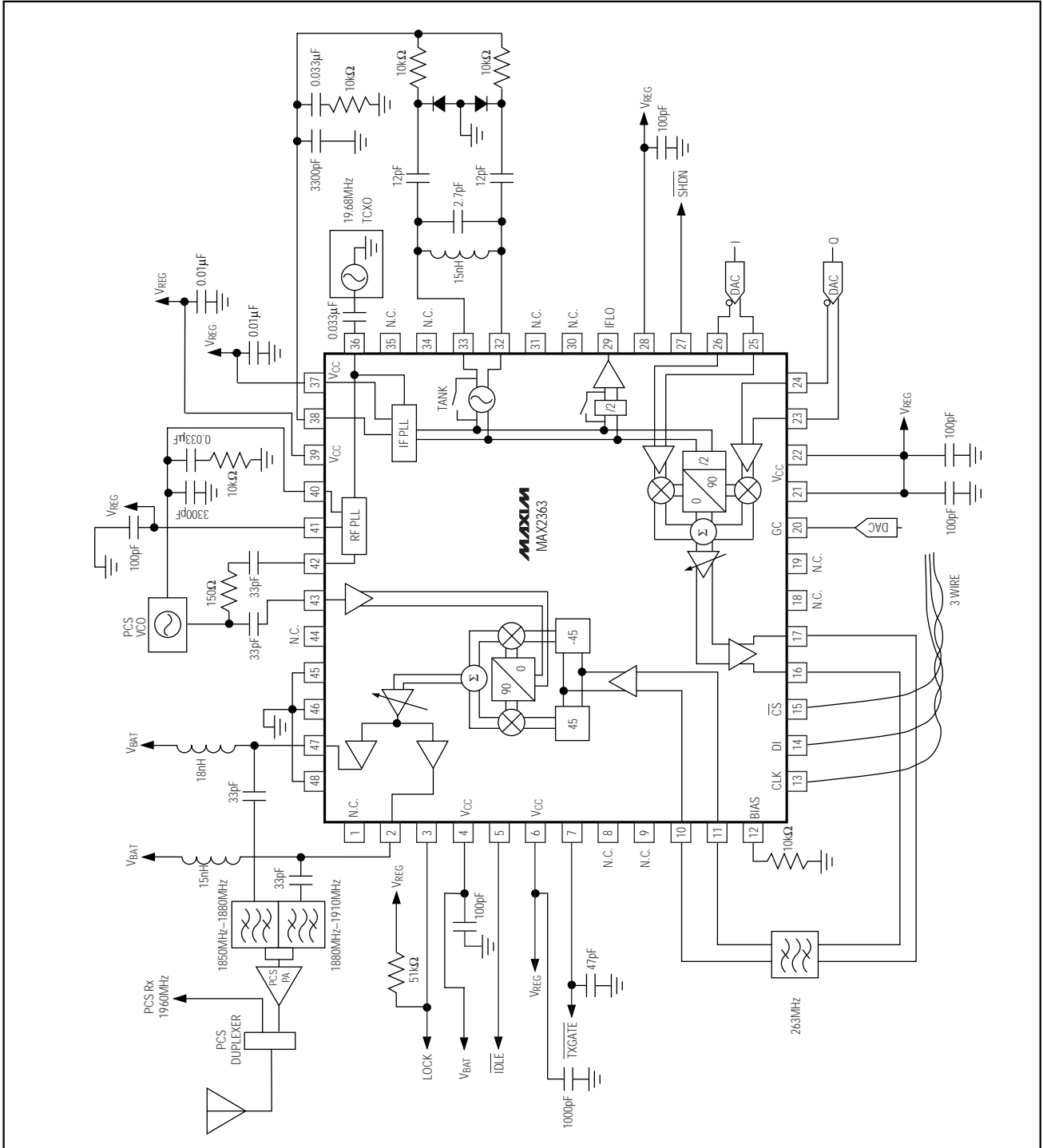

Figure 3. MAX2363 Typical Application Circuit

Complete Dual-Band Quadrature Transmitters

MAX2361/MAX2363/MAX2365

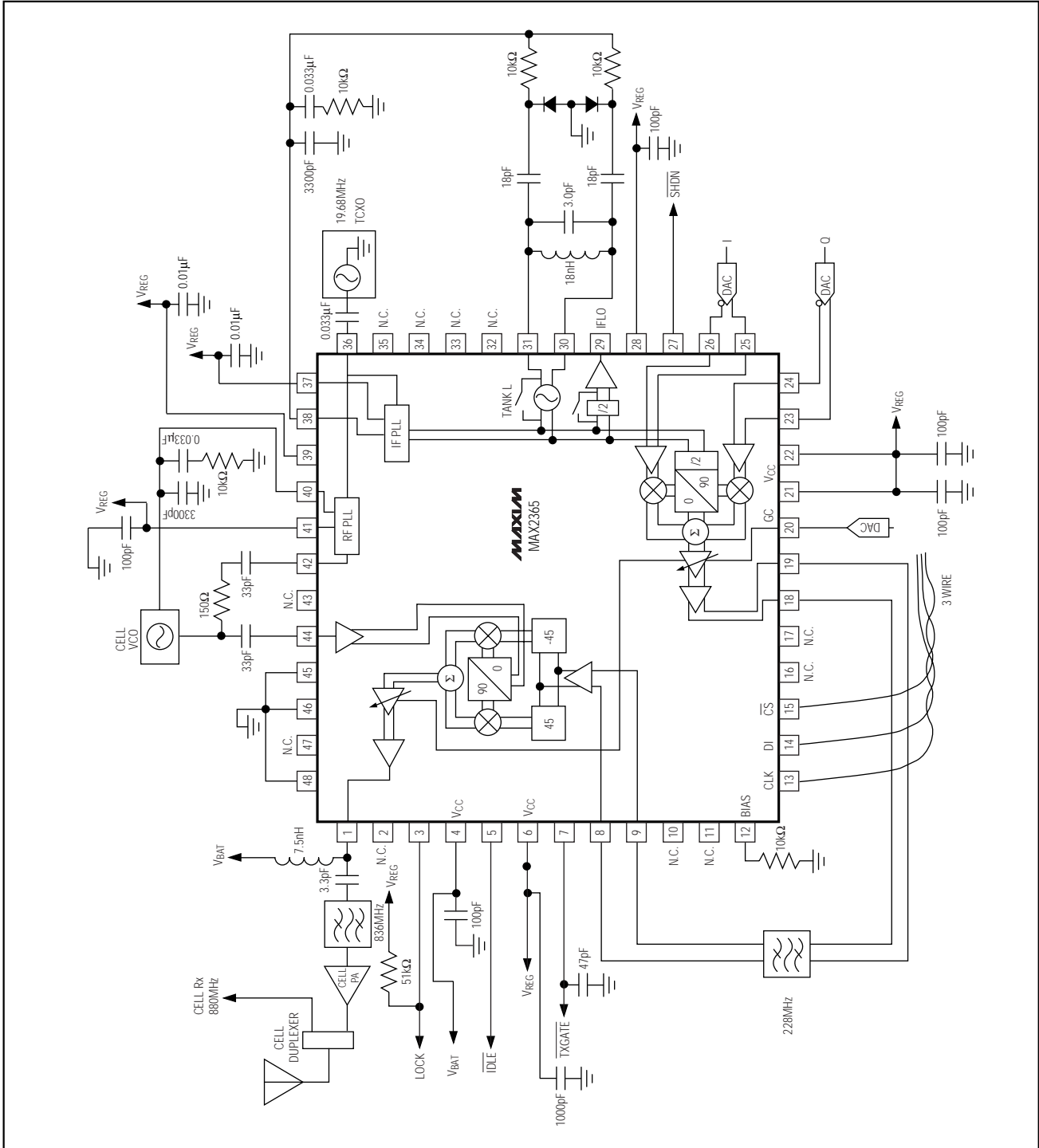

Figure 4. MAX2365 Typical Application Circuit

Complete Dual-Band Quadrature Transmitters

MAX2361/MAX2363/MAX2365

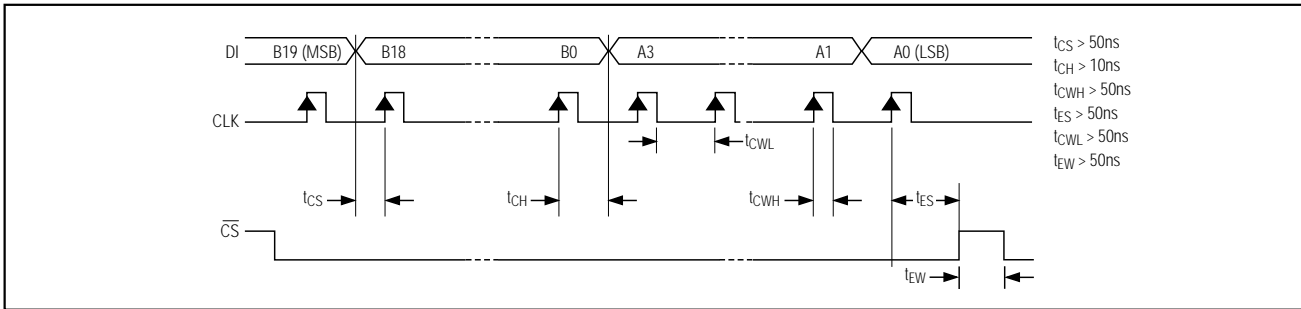

Figure 5. 3-Wire Interface Diagram

High-frequency bypass capacitors are required close to the pins with a dedicated via to ground. The 48-pin QFN-EP package provides minimal inductance ground by using an exposed paddle under the part. Provide at least five low-inductance vias under the paddle to ground, to minimize ground inductance. Use a solid ground plane wherever possible. Any cutout in the ground plane may act as slot radiator and reduce its shield effectiveness.

Keep the RF LO traces as short as possible to reduce LO radiation and susceptibility to interference.

IF Tank Design

The low-band tank (TANKL+, TANKL-) and high-band tank (TANKH+, TANKH-) are fully differential. The external tank components are shown in Figure 6. The frequency of oscillation is determined by the following equation:

$$f_{OSC} = \frac{1}{2\pi \sqrt{(C_{INT} + C_{CENT} + C_{VAR} + C_{PAR}) L}}$$

$$C_{VAR} = \frac{C_D \times C_C}{2(C_D + C_C)}$$

C_{INT} = Internal capacitance of TANK port

C_D = Capacitance of varactor

C_{VAR} = Equivalent variable tuning capacitance

C_{PAR} = Parasitic capacitance due to PC board pads and traces

C_{CENT} = External capacitor for centering oscillation frequency

C_C = External coupling capacitor to the varactor

Table 10 shows possible component values for various oscillation frequencies.

Internal to the IC, the charge pump will have a leakage of less than 10nA. This is equivalent to a 300MΩ shunt

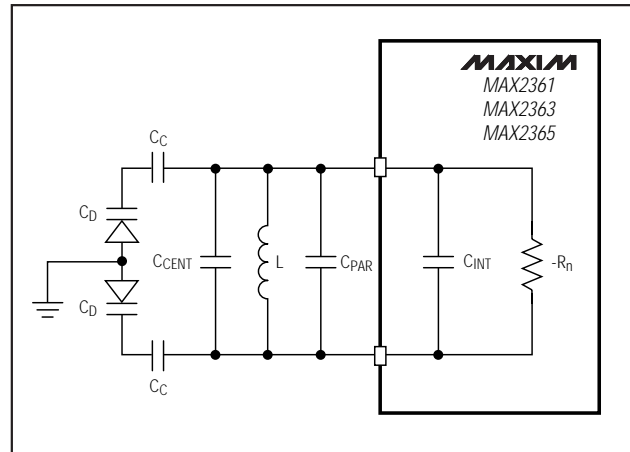

Figure 6. Tank Port Oscillator

resistor. The charge-pump output must see an extremely high DC resistance of greater than 300MΩ. This minimizes charge-pump spurs at the comparison frequency. Make sure there is no solder flux under the varactor or loop filter.

Layout Issues

The MAX2361/MAX2363/MAX2365 EV kit can be used as a starting point for layout. For best performance, take into consideration power-supply issues as well as the RF, LO, and IF layout.

Power-Supply Layout

To minimize coupling between different sections of the IC, the ideal power-supply layout is a star configuration, which has a large decoupling capacitor at a central VCC node. The VCC traces branch out from this node, each going to a separate VCC node in the MAX2361/MAX2363/MAX2365 circuit. At the end of each trace is a bypass capacitor with impedance to ground less than 1Ω at the frequency of interest. This arrangement pro-

Complete Dual-Band Quadrature Transmitters

Table 10. Suggested Component Values for the IF Oscillators

	OSC. FREQ. (MHz)	L (nH)	C _{CENT} (pF)	C _c (pF)	C _D
TANKL	260.76	39	2.4	18	SMV1763-079
	400.0	30	3.3	18	SMV1763-079
	457.2	18	3.0	18	SMV1763-079
TANKH	330.0	22	4.3	12	SMV1763-079
	527.2	15	2.7	12	SMV1763-079
	760.0	11	1.2	9	SMV1763-079

Table 11. Cascaded TDMA Performance

(From I/Q input to PA driver output, IQ_LEVEL = 0, V_I = V_O = 104mV_{RMS}, IS136 NADC modulation or 415mV_{p-p} differential with 0.1% 3dB peak-average ratio.)

PARAMETER	CONDITION	VALUE	UNITS
IFL Frequency	IF_SEL = 0	228.6	MHz
IFH Frequency	IF_SEL = 1	263.6	MHz
RFL Frequency Range		824–849	MHz
RFH0 Frequency Range		1850–1910	MHz
LOL Frequency Range		1052.6–1077.6	MHz
LOH Frequency Range		2113.6–2173.6	MHz
LO Input Level	LOL or LOH	-7	dBm
RFL Output Power	V _{GC} = 2.4V, MPL = 0	+7	dBm
	V _{GC} = 2.4V, MPL = 1	+10	
RFH0 Output Power	V _{GC} = 2.4V, MPL = 0	+6	dBm
	V _{GC} = 2.4V, MPL = 1	+10	
Adjacent Channel Power Ratio	f _{OFFSET} = ±30kHz in 25kHz BW	-33	dBc
Alternate Channel Power Ratio	f _{OFFSET} = ±60kHz in 25kHz BW	-52	dBc
Receive Band Noise Power	MPL = 0, P _{RFH0} = +6dBm, f _{RFH0} = 1910MHz, measured at 1930MHz	-134	dBm/Hz
	MPL = 1, P _{RFH0} = +10dBm, f _{RFH0} = 1910MHz, measured at 1930MHz	-131	
	MPL = 0, P _{RFL} = +7dBm, f _{RFL} = 849MHz, measured at 869MHz	-134	
	MPL = 1, P _{RFL} = +10dBm, f _{RFL} = 849MHz, measured at 869MHz	-131	

Complete Dual-Band Quadrature Transmitters

Table 12. Cascaded WCDMA Performance.

(From I/Q input to PA driver output, IQ_LEVEL = 1, V_I = V_Q = 146mV_{RMS}, uplink 3GPP modulation or 600mVp-p differential with 0.1% 3.25dB peak-average ratio.)

PARAMETER	CONDITIONS	VALUE	UNITS
Intermediate Frequency	IF_SEL = 1	380	MHz
RFH0 Frequency Range		1920–1980	MHz
LOH Frequency Range		2300–2360	MHz
LO Input Level	LOH	-7	dBm
Maximum RFH0 Output Power	V _{GC} = 2.4V, MPL = 1	8	dBm
Minimum RFH0 Output Power	ZERO_BIAS = 1, SNR = 20dB	-75	dBm
Zero Bias Gain Step	From ZERO_BIAS = 1 to ZERO_BIAS = 0, V _{GC} = 2.0V	27	dB
Adjacent Channel Power Ratio	f _{OFFSET} = ±3.5MHz in 30kHz BW	-60	dBc
	f _{OFFSET} = ±5MHz in 3.84MHz BW	-45	
	f _{OFFSET} = ±10MHz in 3.84MHz BW	-58	
Receive Band Noise Power	MPL = 1, P _{RFH0} = +8dBm, f _{RFH0} = 1950MHz, measured at 2140MHz	-134	dBm/Hz

vides local decoupling at each V_{CC} pin. Use at least one via per bypass capacitor for a low-inductance ground connection. Also, connect the exposed paddle to PC board GND with multiple vias to provide the lowest inductance possible.

Matching Network Layout

The layout of a matching network can be very sensitive to parasitic circuit elements. To minimize parasitic inductance, keep all traces short and place components as close to the IC as possible. To minimize parasitic capacitance, a cutout in the ground plane (and

any other planes) below the matching network components can be used.

On the high-impedance ports (e.g., IF inputs and outputs), keep traces short to minimize shunt capacitance.

Tank Layout

Keep the traces coming out of the tank short to reduce series inductance and shunt capacitance. Keep the inductor pads and coupling capacitor pads small to minimize stray shunt capacitance.

Selector Guide

PART	IF RANGE (MHz)	RF LO RANGE (MHz)	RF RANGE (MHz)
MAX2361	120 to 235	800 to 1150	800 to 1000
	120 to 380	1400 to 2360	1700 to 2000
MAX2363	120 to 380	1400 to 2360	1700 to 2000
MAX2365	120 to 235	800 to 1150	800 to 1000

MAX2361/MAX2363/MAX2365

Complete Dual-Band Quadrature Transmitters

Pin Configurations

MAX2361/MAX2363/MAX2365

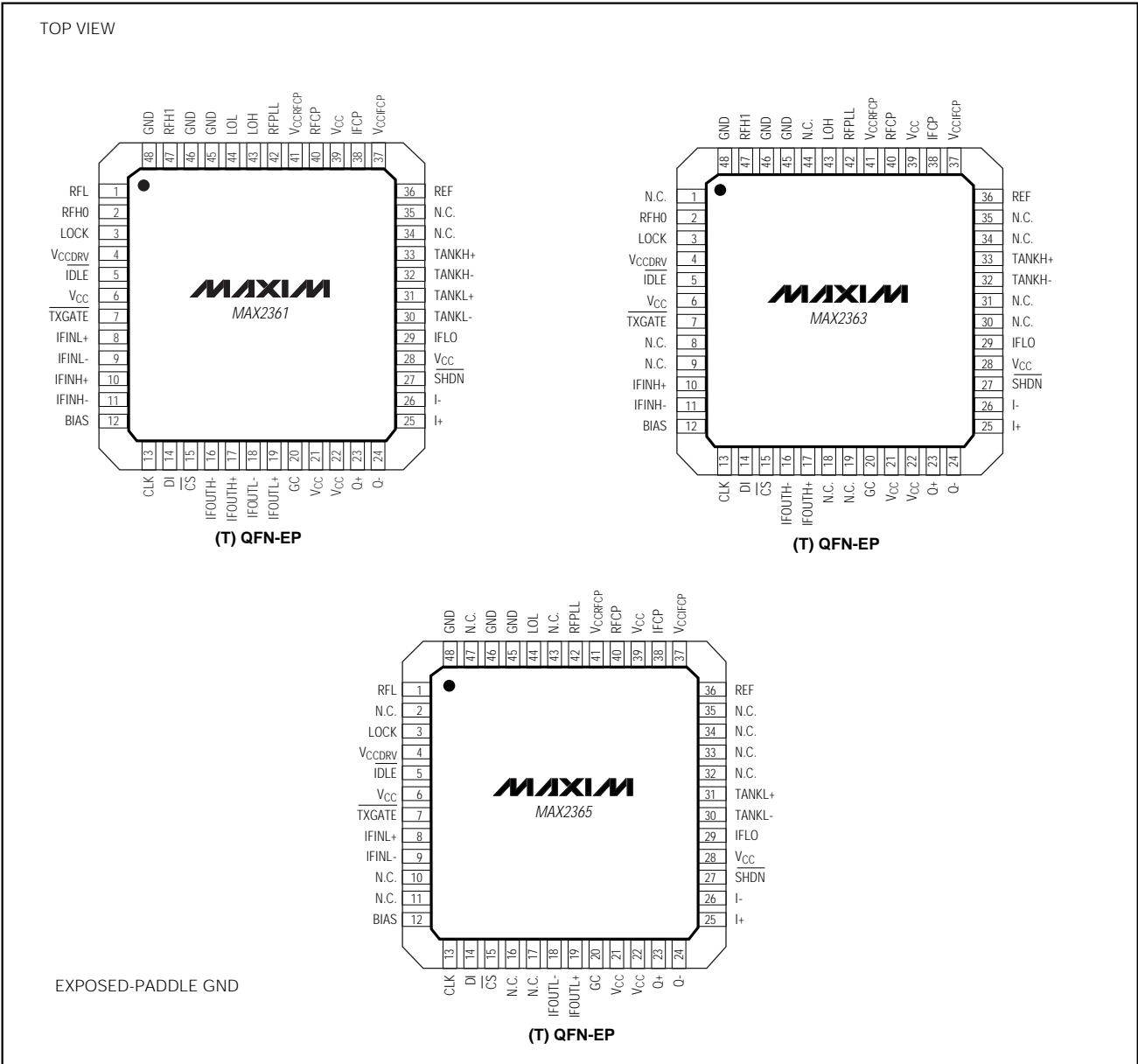

Complete Dual-Band Quadrature Transmitters

Package Information

(The package drawing(s) in this data sheet may not reflect the most current specifications. For the latest package outline information go to www.maxim-ic.com/packages.)

MAX2361/MAX2363/MAX2365

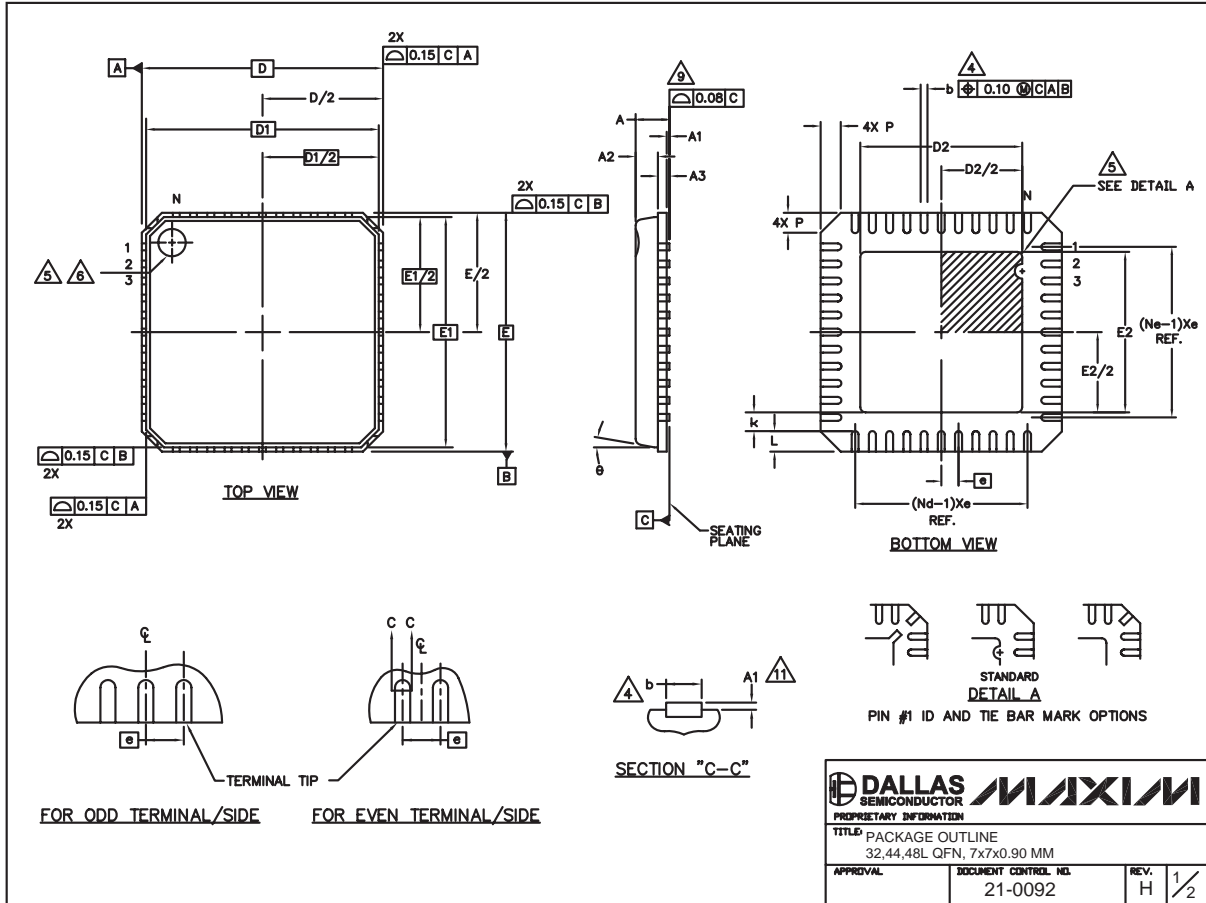

Complete Dual-Band Quadrature Transmitters

Package Information (continued)

(The package drawing(s) in this data sheet may not reflect the most current specifications. For the latest package outline information go to www.maxim-ic.com/packages.)

MAX2361/MAX2363/MAX2365

COMMON DIMENSIONS									
PKG	32L 7x7			44L 7x7			48L 7x7		
SYMBOL	MIN.	NDM.	MAX.	MIN.	NDM.	MAX.	MIN.	NDM.	MAX.
A	0.80	0.90	1.00	0.80	0.90	1.00	0.80	0.90	1.00
A1	0.00	0.01	0.05	0.00	0.01	0.05	0.00	0.01	0.05
A2	0.00	0.65	1.00	0.00	0.65	1.00	0.00	0.65	1.00
A3	0.20 REF			0.20 REF			0.20 REF		
b	0.23	0.28	0.35	0.18	0.23	0.30	0.18	0.23	0.30
D	6.90	7.00	7.10	6.90	7.00	7.10	6.90	7.00	7.10
D1	6.75 BSC			6.75 BSC			6.75 BSC		
E	6.90	7.00	7.10	6.90	7.00	7.10	6.90	7.00	7.10
E1	6.75 BSC			6.75 BSC			6.75 BSC		
e	0.65 BSC			0.50 BSC			0.50 BSC		
k	0.25	-	-	0.25	-	-	0.25	-	-
L	0.35	0.55	0.75	0.35	0.55	0.75	0.30	0.40	0.50
N	32			44			48		
Nd	8			11			12		
Ne	8			11			12		
P	0.00	0.42	0.60	0.00	0.42	0.60	0.00	0.42	0.60
u	0"		12"	0"		12"	0"		12"

EXPOSED PAD VARIATIONS						
PKG. CODES	D2			E2		
	MIN.	NDM.	MAX.	MIN.	NDM.	MAX.
G3277-2	4.55	4.70	4.85	4.55	4.70	4.85
G4477-1	3.65	3.80	3.95	3.65	3.80	3.95
G4477-2	4.55	4.70	4.85	4.55	4.70	4.85
G4477-3	3.15	3.30	3.45	3.15	3.30	3.45
G4877-1	4.95	5.10	5.25	4.95	5.10	5.25
G4877-2	5.45	5.60	5.75	5.45	5.60	5.75

NOTES:

1. DIE THICKNESS ALLOWABLE IS 0.305mm MAXIMUM (.012 INCHES MAXIMUM).
2. DIMENSIONING & TOLERANCES CONFORM TO ASME Y14.5M. - 1994.
3. N IS THE NUMBER OF TERMINALS.
Nd IS THE NUMBER OF TERMINALS IN X-DIRECTION & Ne IS THE NUMBER OF TERMINALS IN Y-DIRECTION.
- ⚠ DIMENSION b APPLIES TO PLATED TERMINAL AND IS MEASURED BETWEEN 0.20 AND 0.25mm FROM TERMINAL TIP.
- ⚠ THE PIN #1 IDENTIFIER MUST EXIST ON THE TOP SURFACE OF THE PACKAGE BY USING INDENTATION MARK OR INK/LASER MARKED. DETAILS OF PIN #1 IDENTIFIER IS OPTIONAL, BUT MUST BE LOCATED WITHIN ZONE INDICATED.
- ⚠ EXACT SHAPE AND SIZE OF THIS FEATURE IS OPTIONAL.
7. ALL DIMENSIONS ARE IN MILLIMETERS.
8. PACKAGE WARPAGE MAX 0.08mm.
- ⚠ APPLIED FOR EXPOSED PAD AND TERMINALS.
EXCLUDE EMBEDDED PART OF EXPOSED PAD FROM MEASURING.
10. MEETS JEDEC MO220 EXCEPT DIMENSION "b" MINIMUM.
- ⚠ APPLY ONLY FOR TERMINAL.
12. THIS PACKAGE OUTLINE APPLIES TO ANVIL SINGULATION(STEPPEDED SIDES).

	
<small>PROPRIETARY INFORMATION</small>	
<small>TITLE PACKAGE OUTLINE, 32,44,48L QFN, 7x7x0.90 MM</small>	
<small>APPROVAL</small>	<small>DOCUMENT CONTROL NO. 21-0092</small>
<small>REV. H</small>	<small>2/2</small>

Complete Dual-Band Quadrature Transmitters

Package Information (continued)

(The package drawing(s) in this data sheet may not reflect the most current specifications. For the latest package outline information go to www.maxim-ic.com/packages.)

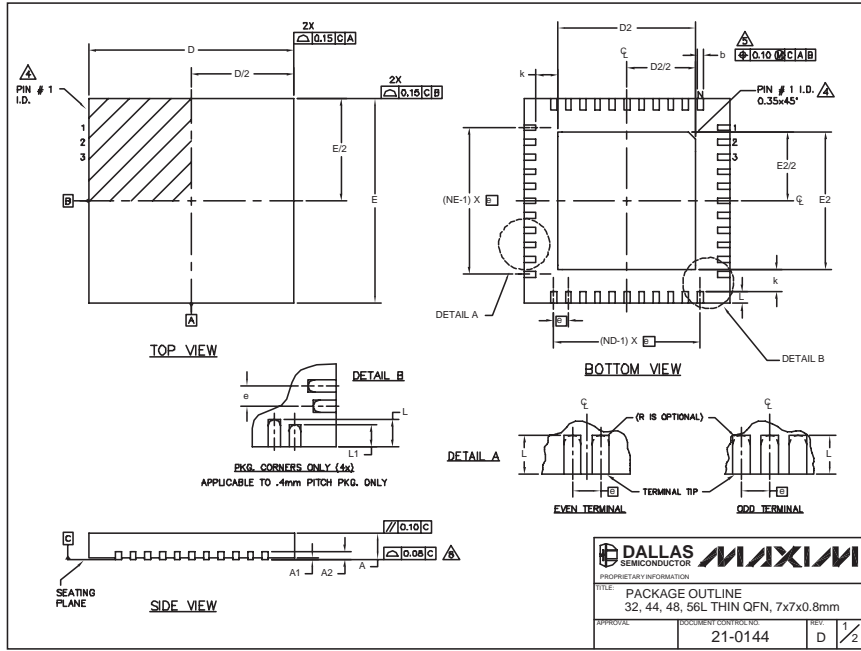

NOTES:

- DIMENSIONING & TOLERANCING CONFORM TO ASME Y14.5M-1994.
- ALL DIMENSIONS ARE IN MILLIMETERS. ANGLES ARE IN DEGREES.
- N IS THE TOTAL NUMBER OF TERMINALS.
- THE TERMINAL #1 IDENTIFIER AND TERMINAL NUMBERING CONVENTION SHALL CONFORM TO JESD 95-1 SPP-012. DETAILS OF TERMINAL #1 IDENTIFIER ARE OPTIONAL, BUT MUST BE LOCATED WITHIN THE ZONE INDICATED. THE TERMINAL #1 IDENTIFIER MAY BE EITHER A MOLD OR MARKED FEATURE.
- DIMENSION b APPLIES TO METALLIZED TERMINAL AND IS MEASURED BETWEEN 0.25 mm AND 0.30 mm FROM TERMINAL TIP.
- ND AND NE REFER TO THE NUMBER OF TERMINALS ON EACH D AND E SIDE RESPECTIVELY.
- DEPOPULATION IS POSSIBLE IN A SYMMETRICAL FASHION.
- COPLANARITY APPLIES TO THE EXPOSED HEAT SINK SLUG AS WELL AS THE TERMINALS.
- DRAWING CONFORMS TO JEDEC MO220 EXCEPT THE EXPOSED PAD DIMENSIONS OF T3277-1; T4877-1/-2/-3/-4/-5/-6 & T5677-1.
- WARRPAGE SHALL NOT EXCEED 0.10 mm.

PKG. CODES	DEPOPULATED LEADS	D2				E2				JEDEC MO220 REV. C	DOWN BONDS ALLOWED
		MIN.	NOM.	MAX.	MIN.	NOM.	MAX.	MIN.	NOM.		
T3277-1	-	4.55	4.70	4.85	4.55	4.70	4.85	-	-	NO	
T3277-2	-	4.65	4.70	4.85	4.65	4.70	4.85	-	-	YES	
T4477-1	-	4.55	4.70	4.85	4.55	4.70	4.85	WKD-1	NO		
T4477-2	-	4.65	4.70	4.85	4.65	4.70	4.85	WKD-1	YES		
T4477-3	-	4.55	4.70	4.85	4.55	4.70	4.85	WKD-1	YES		
T4877-1*	13,24,37,48	4.20	4.30	4.40	4.20	4.30	4.40	-	NO		
T4877-2	-	5.45	5.60	5.63	5.45	5.60	5.63	-	NO		
T4877-3	-	4.95	5.10	5.25	4.95	5.10	5.25	-	YES		
T4877-4	-	5.45	5.60	5.63	5.45	5.60	5.63	-	YES		
T4877-5	-	2.40	2.50	2.60	2.40	2.50	2.60	-	NO		
T4877-6	-	5.45	5.60	5.63	5.45	5.60	5.63	-	NO		
T6677-1	-	5.20	5.30	5.40	5.20	5.30	5.40	-	YES		

* NOTE: T4877-1 IS A CUSTOM 48L PKG. WITH 4 LEADS DEPOPULATED. TOTAL NUMBER OF LEADS ARE 44.

DALLAS SEMICONDUCTOR
MAXIM
 PACKAGE OUTLINE
 32, 44, 48, 56L THIN QFN, 7x7x0.8mm
 21-0144

Maxim cannot assume responsibility for use of any circuitry other than circuitry entirely embodied in a Maxim product. No circuit patent licenses are implied. Maxim reserves the right to change the circuitry and specifications without notice at any time.

Maxim Integrated Products, 120 San Gabriel Drive, Sunnyvale, CA 94086 408-737-7600 **29**

MAX2361/MAX2363/MAX2365