

## Excellent Integrated System Limited

Stocking Distributor

Click to view price, real time Inventory, Delivery & Lifecycle Information:

[Standex-Meder Electronics](#)  
[ORD211-2030](#)

For any questions, you can email us directly:

[sales@integrated-circuit.com](mailto:sales@integrated-circuit.com)

# REED SWITCH

## ORD211

### Ultra-miniature

#### ■ GENERAL DESCRIPTION

The ORD211 is a small single-contact reed switch designed for general control of low-level loads less than 24 V. The contacts are sealed within the glass tube with inert gas to maintain contact reliability.

#### ■ FEATURES

- (1) Reed contacts are hermetically sealed within a glass tube with inert gas and do not receive any influence from the external atmospheric environment.
- (2) Quick response
- (3) The structure comprises the operating parts and electrical circuits arranged coaxially. Reed switches are suited to applications in radio frequency operation.
- (4) Reed switches are compact and light weight.
- (5) Superior corrosion resistance and wear resistance of the contacts assures stable switching operation and long life.
- (6) With a permanent magnet installed, reed switches economically and easily become proximity switches.

#### ■ EXTERNAL DIMENSIONS (Unit: mm)

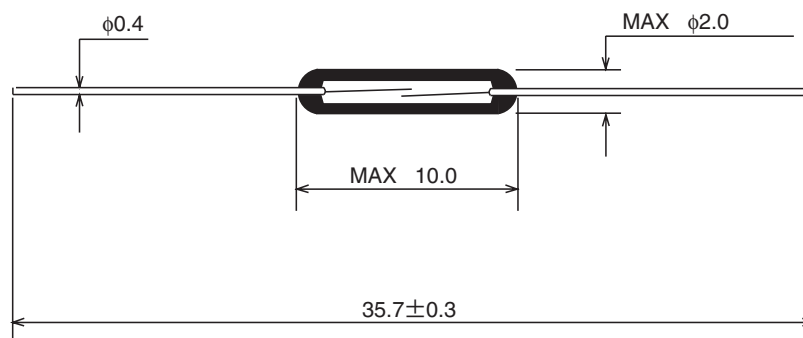

#### ■ APPLICATIONS

- Automotive electronic devices
- Control equipment
- Communication equipment
- Measurement equipment
- Household appliances

● ORD211

■ ELECTRICAL CHARACTERISTICS

Parameter	Rated value	Unit
Pull-in Value (PI)	10~40	AT
Drop-out Value (DO)	5min	AT
Contact resistance (CR)	100max	mΩ
Breakdown voltage	150min	VDC
Insulation resistance	10 <sup>9</sup> min	Ω
Electrostatic capacitance	0.2max	pF
Contact rating	1.0	VA
Maximum switching voltage	24 ( <sup>DC</sup> / <sub>AC</sub> )	V
Maximum switching current	0.1	A
Maximum carry current	0.3	A

3

(1) Drop-out Value vs. Pull-in Value

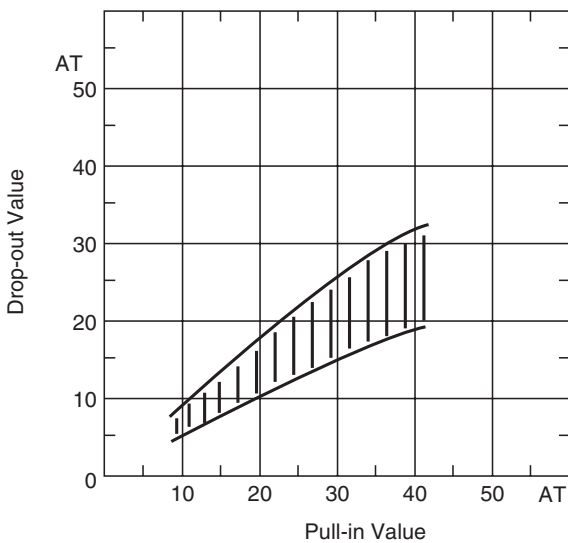

(2) Contact resistance

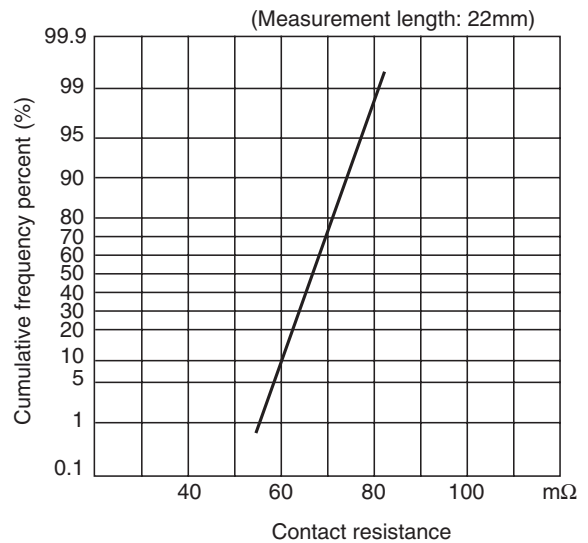

(3) Breakdown voltage

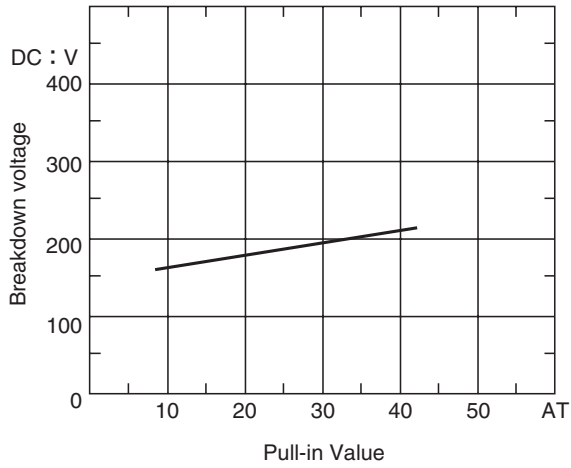

(4) Insulation resistance

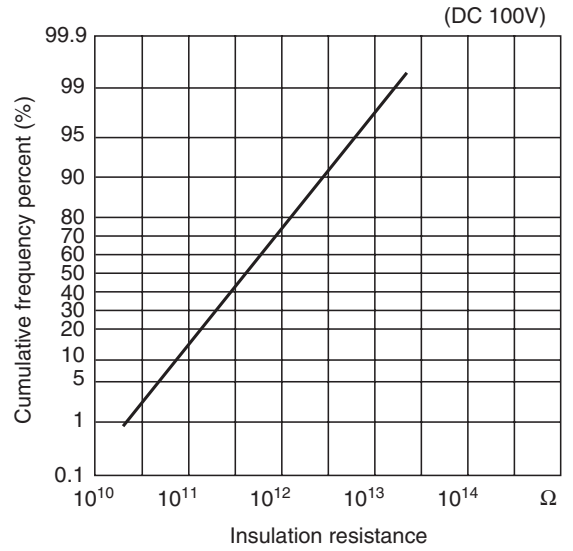

(5) Electrostatic capacitance

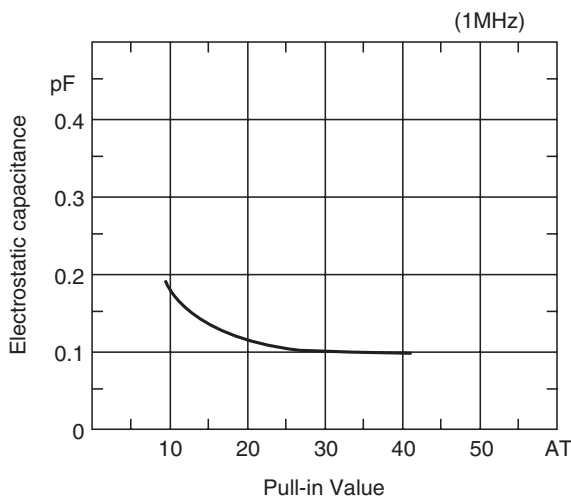

● ORD211

■ OPERATING CHARACTERISTICS

Parameter	Rated value	Unit
Operate time	0.3max	ms
Bounce time	0.3max	ms
Release time	0.05max	ms
Resonant frequency	7500±500	Hz
Maximum operating frequency	500	Hz

(1) Operate time

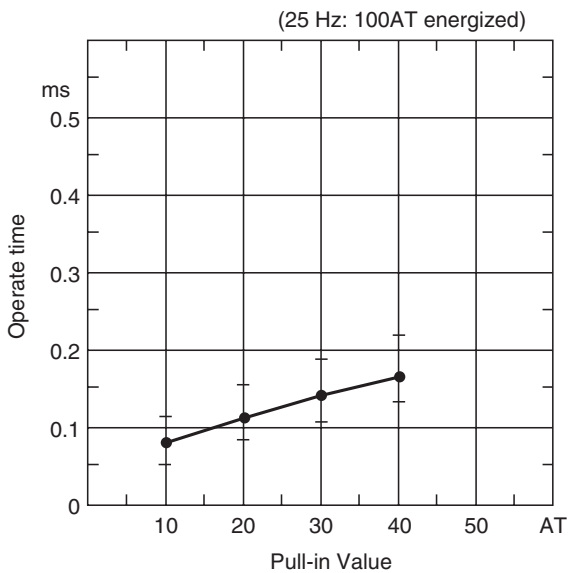

(2) Bounce time

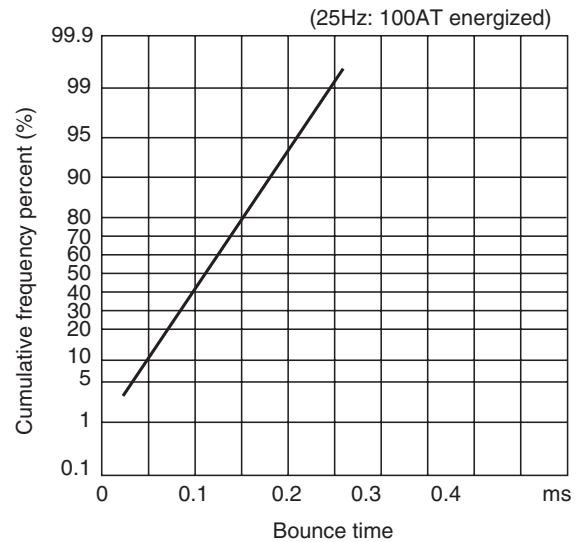

(3) Release time

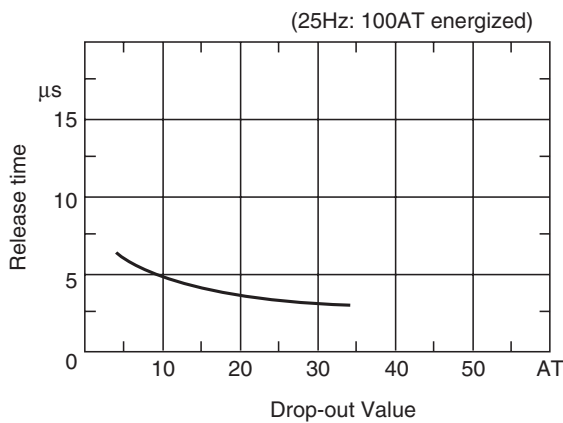

(4) Resonant frequency

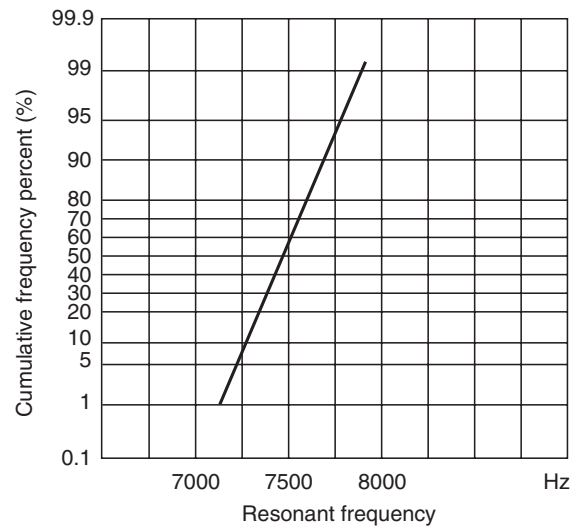

■ MECHANICAL CHARACTERISTICS

(1) Lead tensile test (static load)

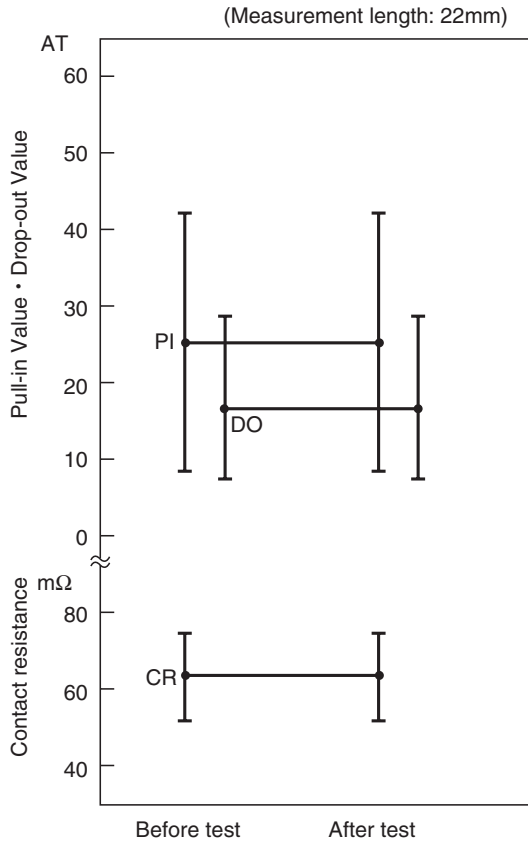

(2) Lead tensile strength

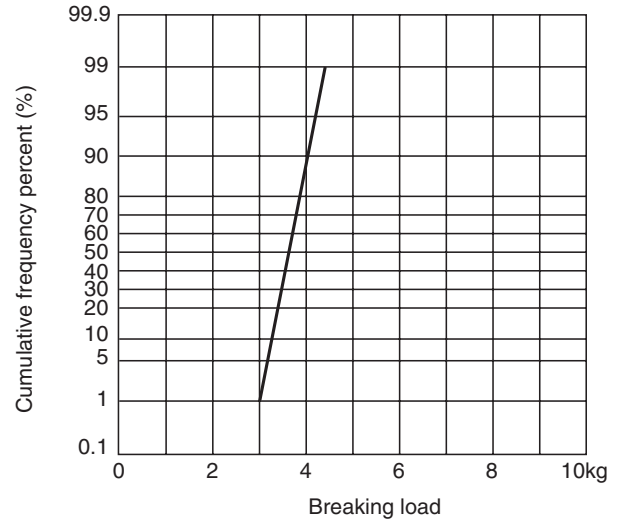

■ ENVIRONMENTAL CHARACTERISTICS

(1) Temperature characteristics

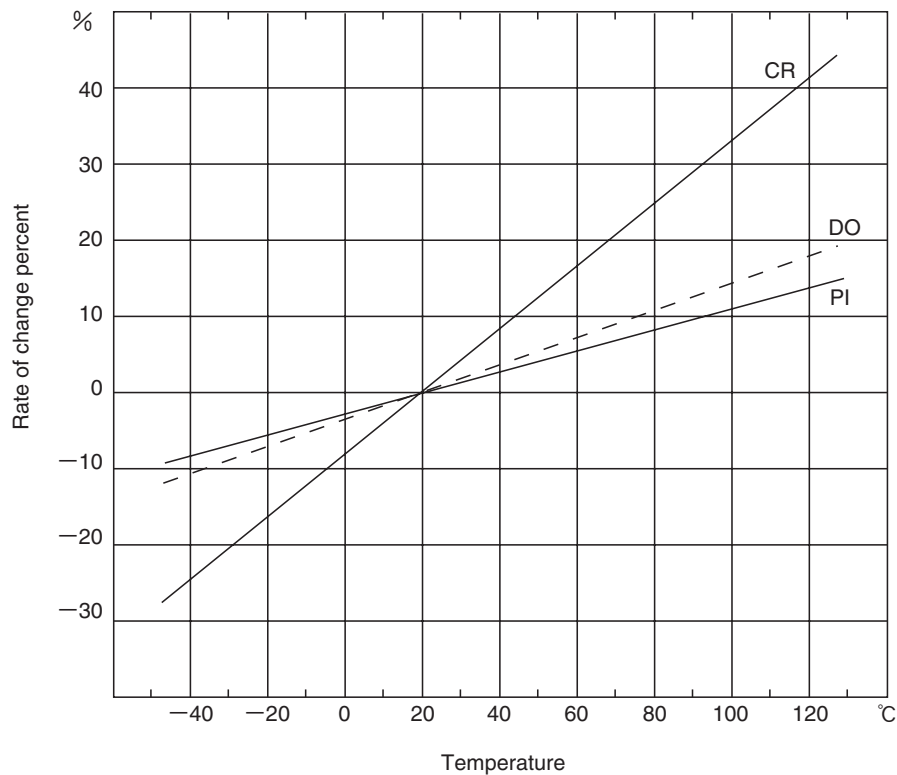

● ORD211

(2) Temperature cycle

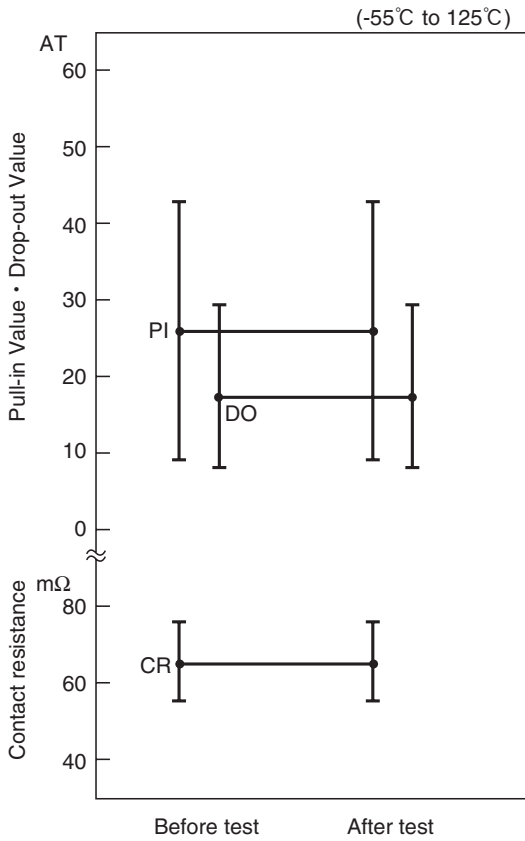

(3) Temperature and humidity cycle

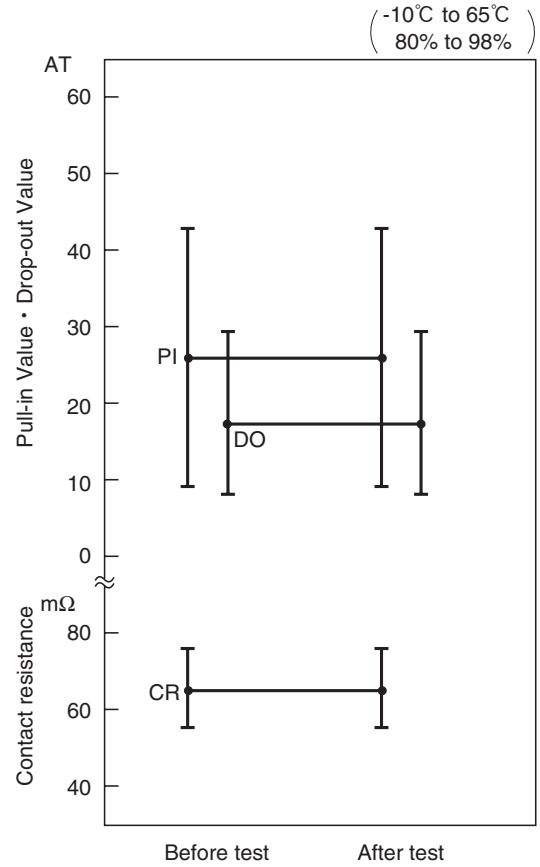

(4) High temperature storage test

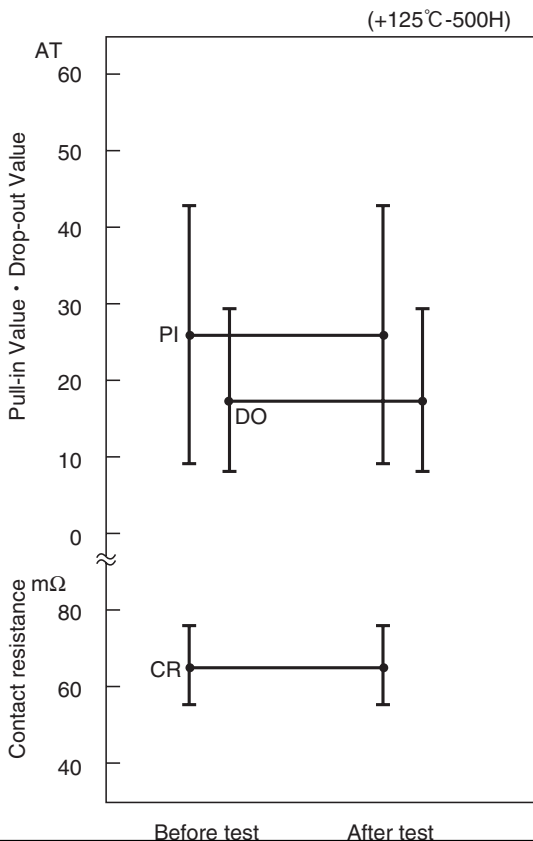

(5) Low temperature storage test

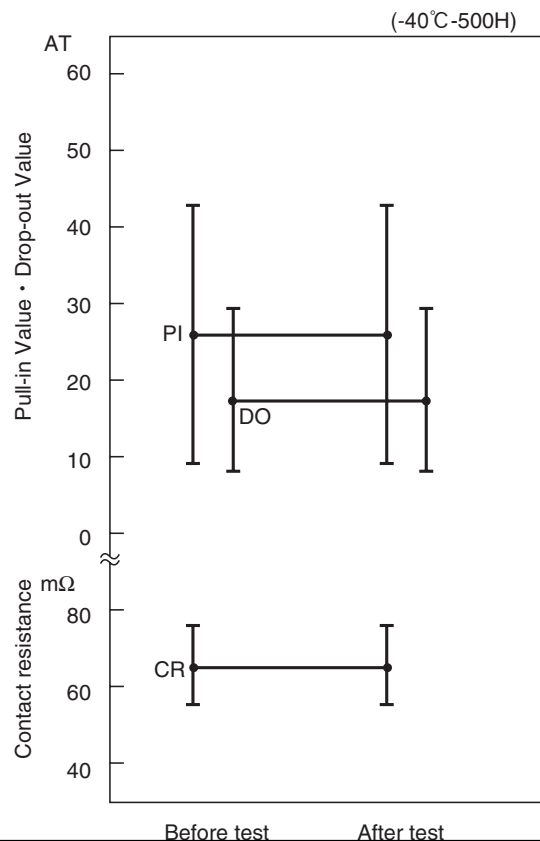

(6) Shock test

1) Electrical characteristics

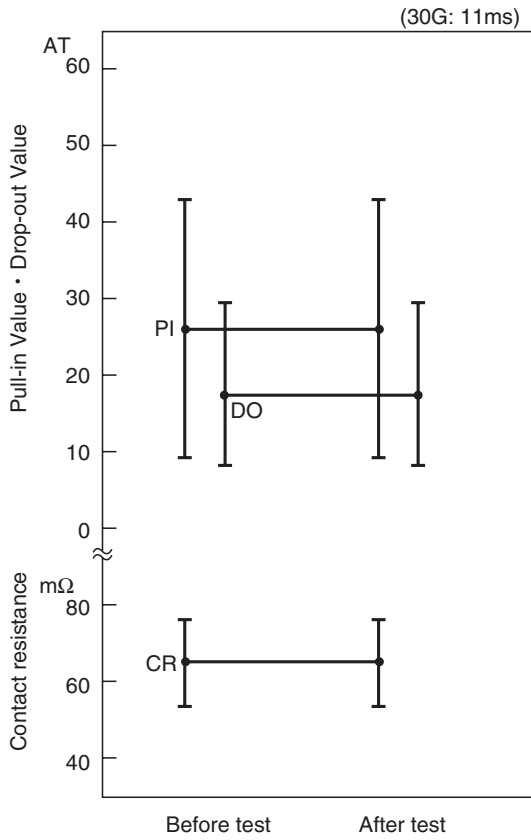

2) Misoperation area

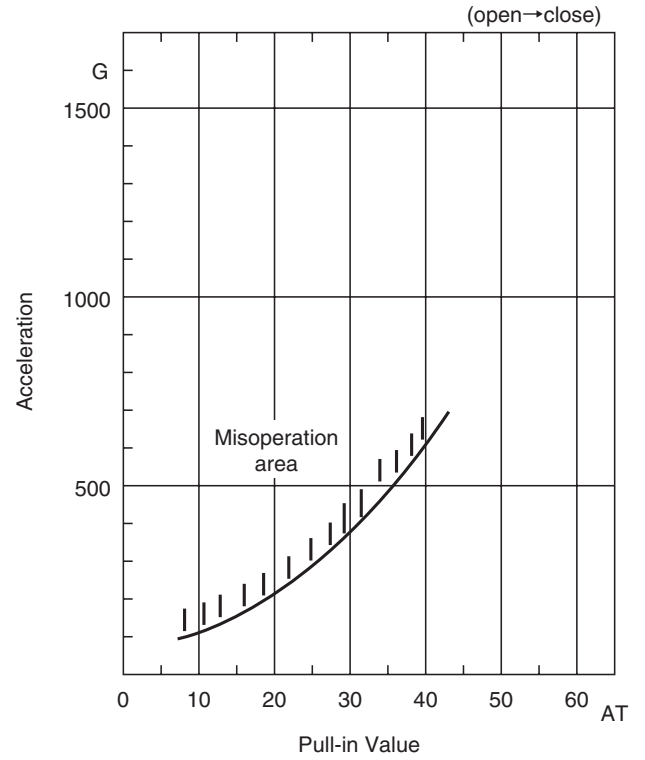

(7) Vibration test

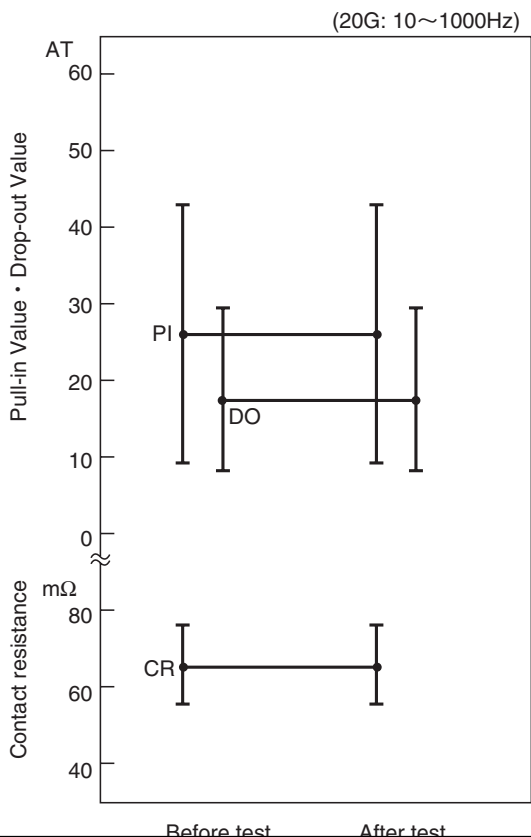



● ORD211

■ LIFE EXPECTANCY DATA: ORD211

Load conditions  
Voltage: 5VDC  
Current: 100  $\mu$ A, 1 mA, 5 mA  
Load: Resistive load

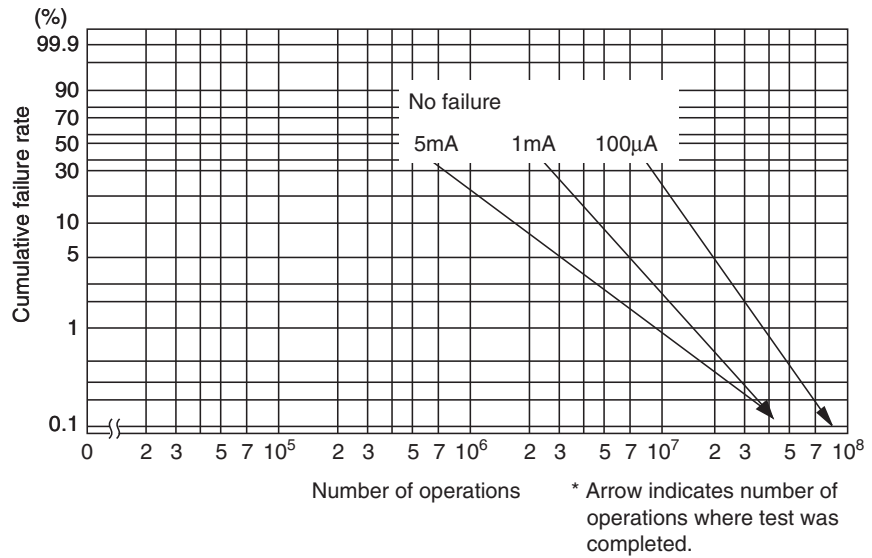

Load conditions  
Voltage: 12VDC  
Current: 5 mA, 10 mA, 100 mA  
Load: Resistive load

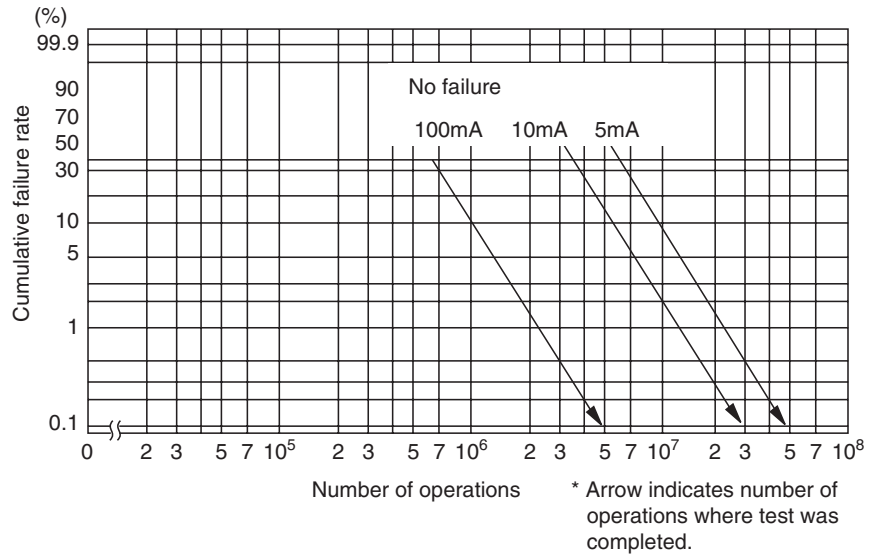

Load conditions  
Voltage: 24VDC  
Current: 1 mA, 10 mA, 50 mA  
Load: Resistive load

