

Excellent Integrated System Limited

Stocking Distributor

Click to view price, real time Inventory, Delivery & Lifecycle Information:

[Comchip Technology](#)

[CPDT5-5V0U](#)

For any questions, you can email us directly:

sales@integrated-circuit.com

SMD ESD Protection Diode



CPDT5-5V0U

RoHS Device

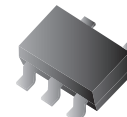

Features

- IEC61000-4-2 Level 4 ESD protection.
- Surface mount package.
- High component density.

Mechanical data

- Case: SOT-23-5 Standard package, molded plastic.
- Terminals: Tin plated, solderable per MIL-STD-750, method 2026.
- Marking code: E5U
- Mounting position: Any.
- Weight: 0.0153 gram (approx.).

Marking: E5U

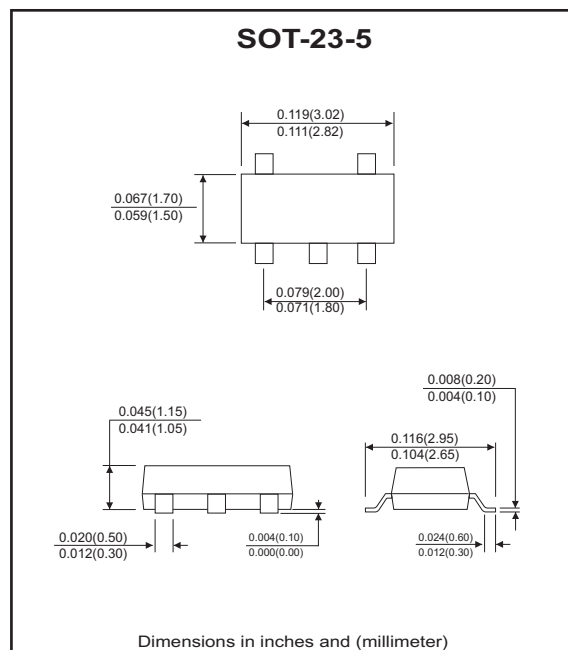
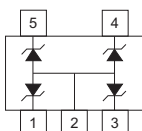

Maximum Rating and Electrical Characteristics

(at TA=25°C unless otherwise noted)

Parameter	Symbol	Conditions	Min	Typ	Max	Unit
Diode breakdown voltage	V _{BD}	I _R = 1mA	6.1		7.1	V
Leakage current	I _L	V _R = 3V		0.1	1.0	uA
Forward voltage	V _F	I _F = 5uA			1.2	V
Junction capacitance	C _T	V _R = 0V, f = 1MHz		60	80	pF
Clamping voltage	V _C	I _{PP} = 1A, T _P =8/20us I _{PP} = 8A, T _P =8/20us			8 10	V
ESD capability	ESD	IEC 61000-4-2(air) IEC 61000-4-2(contact)			15 8	kV
Peak pulse power	P _{PP}				80	W
Operation temperature	T _J				125	°C
Storage temperature	T _{STG}		-55		150	°C

SMD ESD Protection Diode



RATING AND CHARACTERISTIC CURVES (CPDT5-5V0U)

Fig. 1 - 8/20us Peak pulse current waveform acc. IEC 61000-4-5

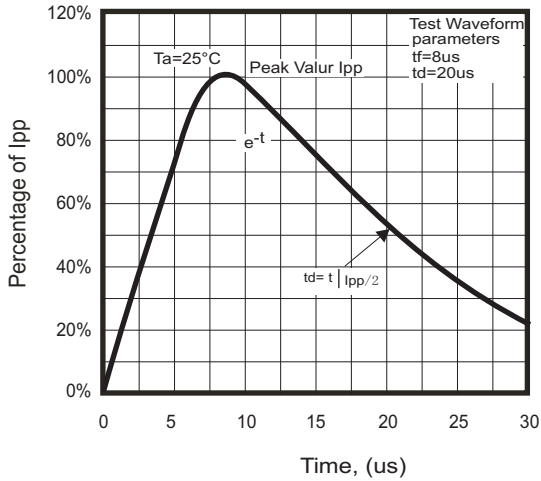

Fig.2 - Power rating derating curve

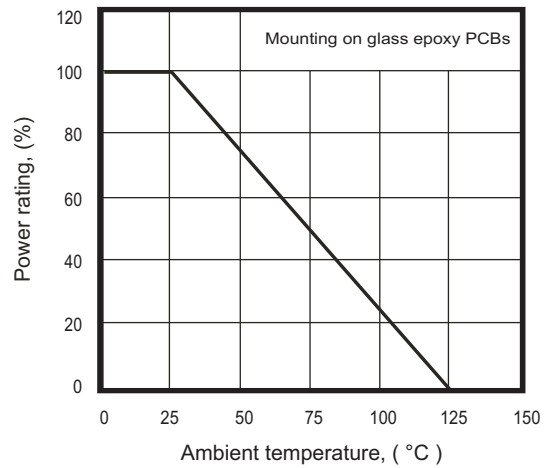

Fig.3 - Clamping voltage vs. peak pulse current

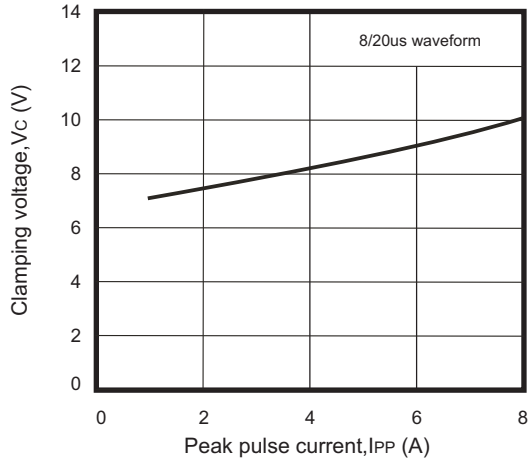
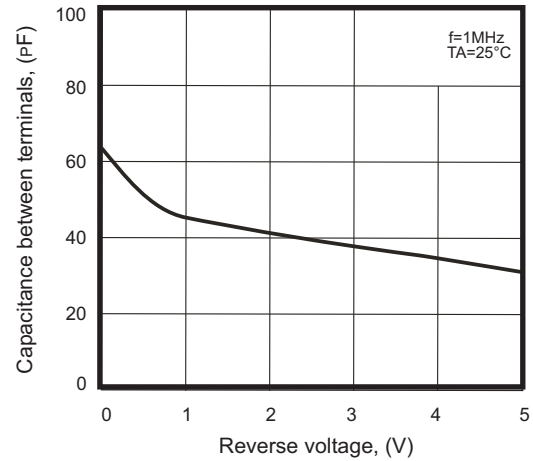

Fig.4 - Capacitance between terminals characteristics



SMD ESD Protection Diode



Reel Taping Specification

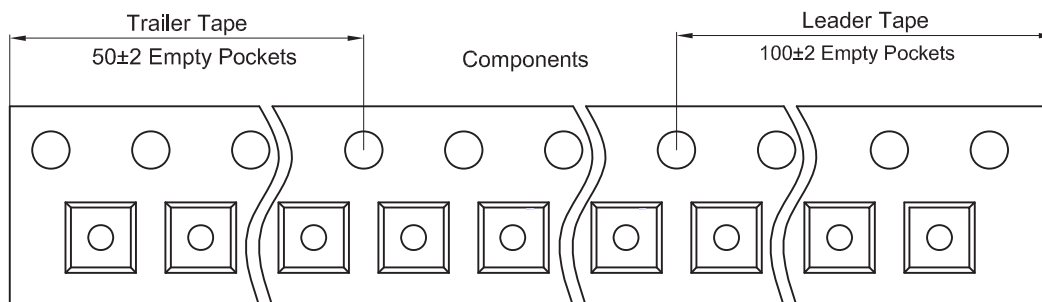
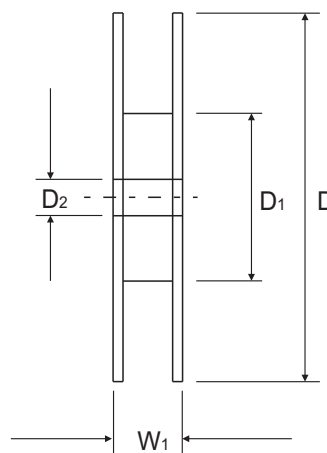
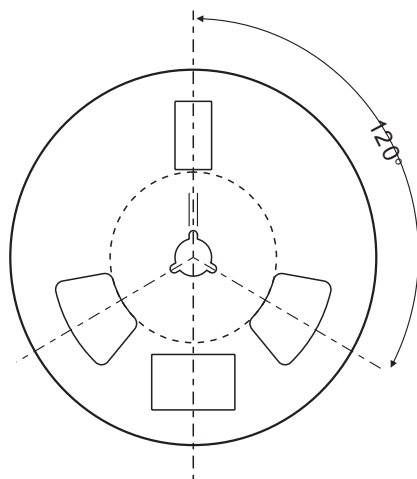
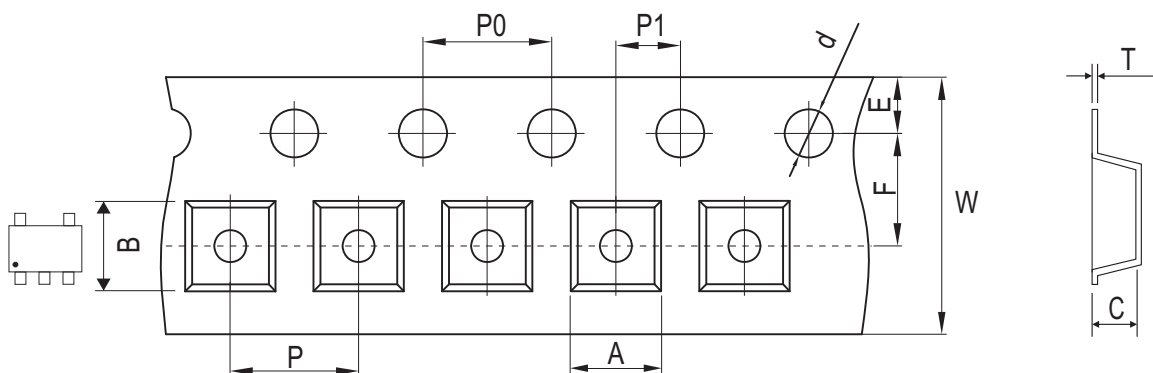

SOT-23-5	SYMBOL	A	B	C	d	D	D1	D2
	(mm)	3.17 ± 0.10	3.23 ± 0.10	1.37 ± 0.10	1.50 ± 0.05	180.0 + 0.00 / - 0.30	60.00 ± 0.50	13.00 ± 0.20
	(inch)	0.125 ± 0.004	0.127 ± 0.004	0.054 ± 0.004	0.059 ± 0.002	7.087 + 0.00 / - 0.012	2.362 ± 0.020	0.512 ± 0.008

SOT-23-5	SYMBOL	E	F	P	P0	P1	W	W1
	(mm)	1.75 ± 0.10	3.50 ± 0.05	4.00 ± 0.10	4.00 ± 0.10	2.00 ± 0.05	8.00 + 0.30 / - 0.10	12.30 ± 0.20
	(inch)	0.069 ± 0.004	0.138 ± 0.002	0.157 ± 0.004	0.157 ± 0.004	0.079 ± 0.002	0.315 + 0.012 / - 0.004	0.484 ± 0.008

SMD ESD Protection Diode

Marking Code

Part Number	Marking Code
CPDT5-5V0U	E5U

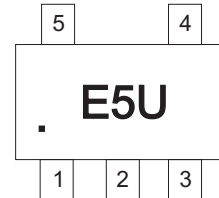

Suggested PAD Layout

SIZE	SOT-23-5	
	(mm)	(inch)
A	1.10	0.043
B	0.60	0.024
C	1.90	0.075
D	2.50	0.098
E	3.60	0.142

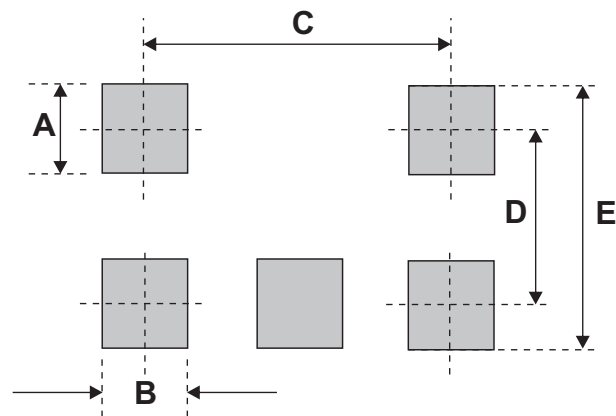

Standard Packaging

Case Type	REEL PACK	
	REEL (pcs)	Reel Size (inch)
SOT-23-5	3,000	7