

## **Excellent Integrated System Limited**

Stocking Distributor

Click to view price, real time Inventory, Delivery & Lifecycle Information:

[Fluke Electronics](#)  
[BP190](#)

For any questions, you can email us directly:  
[sales@integrated-circuit.com](mailto:sales@integrated-circuit.com)

**FLUKE®**

# BP190

## NiMH Rechargeable Battery Pack

### Instruction Sheet

#### Introduction

The BP190 is a NiMH (Nickel-Metal Hydride) Rechargeable Battery Pack designed for use with the Fluke ScopeMeter 190 series.

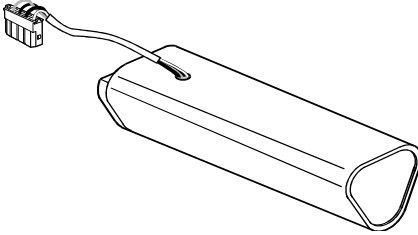

#### Specifications

Nominal voltage: 7.2 V

Capacity: 3500 mAh

Allowable ambient temperature during storage:  
-20 °C to +60 °C (-4 °F to +140 °F)

Allowable ambient temperature during operating :  
0 °C to +50 °C (+32 °F to +122 °F)



Allowable ambient temperature during charging:  
0 °C to +40 °C (+32 °F to +104 °F)

June 1999, Rev.1, 10/01  
© 1999,2001 Fluke Corporation,  
All rights reserved.  
Printed in the Netherlands

All product names are trademarks of their respective companies.

#### Using the Battery Safely

In this instruction sheet a **Warning** identifies conditions and actions that pose hazard(s) to the user. Symbols used on the BP190 and in this instruction sheet are explained in the next table.

	Recycling information
	Disposal information

#### Warning

**Do the following to avoid electrical shock or fire:**

- Do not short circuit the battery.
- Do not expose the battery to fire

#### Disposing the Battery Pack



Do not dispose of the NiMH (Nickel-Metal Hydride) battery pack with other solid waste. Used batteries should be disposed of by a qualified recycler or hazardous materials handler. Contact your authorized FLUKE Service Center for recycling information.

#### General Battery Care

The life of NiMH batteries is strongly influenced by the care that they receive. If properly maintained, the battery is capable of more than 500 charge/discharge cycles before dropping to 80% of capacity. Do not exceed the allowable ambient temperatures during charging, operating, or storage.

#### Caution

**To prevent decrease of the battery capacity, you must charge the batteries at least once a year.**

#### Limited Warranty & Limitation Of Liability

This Fluke product will be free from defects in material and workmanship for one year from the date of purchase. This warranty does not cover damage from accident, neglect, misuse or abnormal conditions of operation or handling. Resellers are not authorized to extend any other warranty on Fluke's behalf. To obtain service during the warranty period, send your defective product to the nearest Fluke Authorized Service Center with a description of the problem.

**THIS WARRANTY IS YOUR ONLY REMEDY. NO OTHER WARRANTIES, SUCH AS FITNESS FOR A PARTICULAR PURPOSE, ARE EXPRESSED OR IMPLIED. FLUKE IS NOT LIABLE FOR ANY SPECIAL, INDIRECT, INCIDENTAL OR CONSEQUENTIAL DAMAGES OR LOSSES, ARISING FROM ANY CAUSE OR THEORY.**

Since some states or countries do not allow the exclusion or limitation of an implied warranty or of incidental or consequential damages, this limitation of liability may not apply to you.

Fluke Corporation	Fluke Industrial B.V.
P.O. Box 9090	P.O. Box 90
Everett WA	7600 AB Almelo
98206-9090, USA	The Netherlands

#### Service Centres

For service information, contact your Fluke service center. To locate an authorized service center, visit us on the World Wide Web:

<http://www.fluke.com>

or call Fluke using any of the phone numbers listed below:

- +1-888-993-5853 in U.S.A. and Canada
- +31-402-675-200 in Europe
- +1-425-446-5500 from other countries

**Replacing the Battery Pack**

**Warning**

To avoid electrical shock, remove the test leads and probes before replacing the battery pack.

Usually it should not be necessary to replace the battery pack. However, if you replace the battery pack, follow steps 1 to 9. (See the figures.) Use a #10 Torx screwdriver for all screws.

Disconnect the test leads and probes both at the source and at the test tool before you open the test tool.

1. Loosen the two screws of the top cover.
2. Place the test tool face down and loosen the two screws of the bottom cover.
3. Remove the top cover and bottom cover.
4. Loosen the two screws of the back cover.
5. Lift the back cover away from the test tool.
6. Take the battery out of the battery compartment.
7. Remove the battery plug from the connector.
8. Install a new battery pack.

*Note*

Ensure that the battery pack is placed in the battery compartment as shown in step ⑦. Use only the Fluke BP190 NiMH Battery Pack.

9. Reinstall all covers in reversed order.

*Note*

When new, the NiMH battery may be empty and must be charged for 4 hours (test tool is off) to fill it completely.

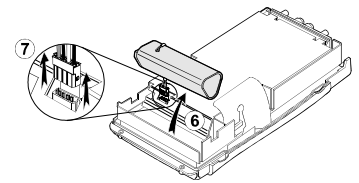
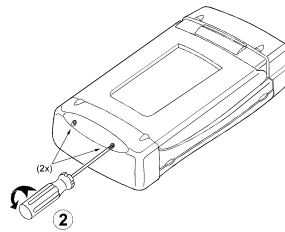
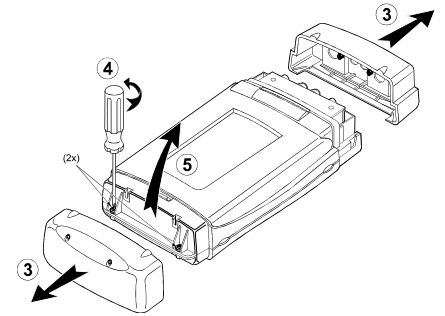
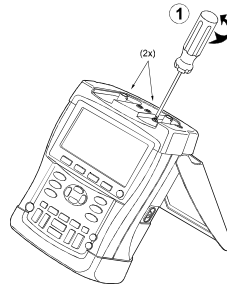

482287200966