

Excellent Integrated System Limited

Stocking Distributor

Click to view price, real time Inventory, Delivery & Lifecycle Information:

[Vishay Semiconductor/Opto Division](#)
[VLMG3100-GS08](#)

For any questions, you can email us directly:

sales@integrated-circuit.com



VLMH310., VLMO310., VLMY310., VLMG310., VLMP310.
 www.vishay.com Vishay Semiconductors

Standard SMD LED PLCC-2

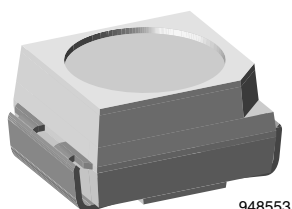

DESCRIPTION

These devices have been designed to meet the increasing demand for surface mounting technology.

The package of the VLM.310. is the PLCC-2.

It consists of a lead frame which is embedded in a white thermoplast. The reflector inside this package is filled up with clear epoxy.

PRODUCT GROUP AND PACKAGE DATA

- Product group: LED
- Package: SMD PLCC-2
- Product series: standard
- Angle of half intensity: ± 60°

FEATURES

- SMD LEDs with exceptional brightness
- Luminous intensity categorized
- Compatible with automatic placement equipment
- EIA and ICE standard package
- Compatible with infrared, vapor phase and wave solder processes according to CECC 00802 and J-STD-020
- Available in 8 mm tape
- Low profile package
- Non-diffused lens: excellent for coupling to light pipes and backlighting
- Low power consumption
- Luminous intensity ratio in one packaging unit $I_{Vmax}/I_{Vmin} \leq 1.6$
- Preconditioning according to JEDEC® level 2a
- AEC-Q101 qualified
- Material categorization: for definitions of compliance please see www.vishay.com/doc?99912

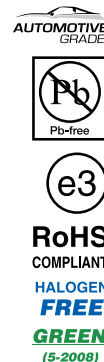

APPLICATIONS

- Automotive: backlighting in dashboards, and switches
- Telecommunication: indicator and backlighting in telephone and fax
- Indicator and backlight for audio and video equipment
- Indicator and backlight in office equipment
- Flat backlight for LCDs, switches, and symbols
- General use

| PARTS TABLE | | | | | | | | | | | | | | |
|---------------|-------------|--------------------------|------|------|------------------------|-----------------|------|------|------------------------|---------------------|------|------|------------------------|--------------|
| PART | COLOR | LUMINOUS INTENSITY (mcd) | | | at I _F (mA) | WAVELENGTH (nm) | | | at I _F (mA) | FORWARD VOLTAGE (V) | | | at I _F (mA) | TECHNOLOGY |
| | | MIN. | TYP. | MAX. | | MIN. | TYP. | MAX. | | MIN. | TYP. | MAX. | | |
| VLMH3100-GS08 | Amber | 2.8 | 10 | - | 10 | 612 | 619 | 625 | 10 | - | 2 | 2.8 | 20 | GaAsP on GaP |
| VLMH3100-GS18 | Amber | 2.8 | 10 | - | 10 | 612 | 619 | 625 | 10 | - | 2 | 2.8 | 20 | GaAsP on GaP |
| VLMH3101-GS08 | Amber | 4.5 | 8.7 | 11.2 | 10 | 612 | 619 | 625 | 10 | - | 2 | 2.8 | 20 | GaAsP on GaP |
| VLMH3101-GS18 | Amber | 4.5 | 8.7 | 11.2 | 10 | 612 | 619 | 625 | 10 | - | 2 | 2.8 | 20 | GaAsP on GaP |
| VLMH3102-GS08 | Amber | 7.1 | 10.3 | 18 | 10 | 612 | 619 | 625 | 10 | - | 2 | 2.8 | 20 | GaAsP on GaP |
| VLMH3102-GS18 | Amber | 7.1 | 10.3 | 18 | 10 | 612 | 619 | 625 | 10 | - | 2 | 2.8 | 20 | GaAsP on GaP |
| VLMO3100-GS08 | Soft orange | 2.8 | 8 | - | 10 | 598 | 605 | 611 | 10 | - | 2 | 2.8 | 20 | GaAsP on GaP |
| VLMO3100-GS18 | Soft orange | 2.8 | 8 | - | 10 | 598 | 605 | 611 | 10 | - | 2 | 2.8 | 20 | GaAsP on GaP |
| VLMO3101-GS08 | Soft orange | 4.5 | 8.6 | 11.2 | 10 | 598 | 605 | 611 | 10 | - | 2 | 2.8 | 20 | GaAsP on GaP |
| VLMO3101-GS18 | Soft orange | 4.5 | 8.6 | 11.2 | 10 | 598 | 605 | 611 | 10 | - | 2 | 2.8 | 20 | GaAsP on GaP |
| VLMY3100-GS08 | Yellow | 2.8 | 10 | | 10 | 581 | 588 | 594 | 10 | - | 2.1 | 2.8 | 20 | GaAsP on GaP |
| VLMY3100-GS18 | Yellow | 2.8 | 10 | | 10 | 581 | 588 | 594 | 10 | - | 2.1 | 2.8 | 20 | GaAsP on GaP |
| VLMY3101-GS08 | Yellow | 4.5 | 7.6 | 11.2 | 10 | 581 | 588 | 594 | 10 | - | 2.1 | 2.8 | 20 | GaAsP on GaP |
| VLMY3101-GS18 | Yellow | 4.5 | 7.6 | 11.2 | 10 | 581 | 588 | 594 | 10 | - | 2.1 | 2.8 | 20 | GaAsP on GaP |
| VLMY3102-GS08 | Yellow | 7.1 | 8.6 | 18 | 10 | 581 | 588 | 594 | 10 | - | 2.1 | 2.8 | 20 | GaAsP on GaP |
| VLMY3102-GS18 | Yellow | 7.1 | 8.6 | 18 | 10 | 581 | 588 | 594 | 10 | - | 2.1 | 2.8 | 20 | GaAsP on GaP |



VLMH310., VLMO310., VLMY310., VLMG310., VLMP310.

www.vishay.com

Vishay Semiconductors

| PARTS TABLE | | | | | | | | | | | | | | |
|---------------|------------|--------------------------|------|------|------------------------|-----------------|------|------|------------------------|---------------------|------|------|------------------------|------------|
| PART | COLOR | LUMINOUS INTENSITY (mcd) | | | at I _F (mA) | WAVELENGTH (nm) | | | at I _F (mA) | FORWARD VOLTAGE (V) | | | at I _F (mA) | TECHNOLOGY |
| | | MIN. | TYP. | MAX. | | MIN. | TYP. | MAX. | | MIN. | TYP. | MAX. | | |
| VLMG3100-GS08 | Green | 4.5 | 12 | - | 10 | 562 | 572 | 575 | 10 | - | 2.2 | 2.8 | 20 | GaP on GaP |
| VLMG3100-GS18 | Green | 4.5 | 12 | - | 10 | 562 | 572 | 575 | 10 | - | 2.2 | 2.8 | 20 | GaP on GaP |
| VLMG3102-GS08 | Green | 11.2 | 13.6 | 18 | 10 | 562 | 572 | 575 | 10 | - | 2.2 | 2.8 | 20 | GaP on GaP |
| VLMG3102-GS18 | Green | 11.2 | 13.6 | 18 | 10 | 562 | 572 | 575 | 10 | - | 2.2 | 2.8 | 20 | GaP on GaP |
| VLMG3105-GS08 | Green | 7.1 | 12 | 18 | 10 | 562 | 572 | 575 | 10 | - | 2.2 | 2.8 | 20 | GaP on GaP |
| VLMG3105-GS18 | Green | 7.1 | 12 | 18 | 10 | 562 | 572 | 575 | 10 | - | 2.2 | 2.8 | 20 | GaP on GaP |
| VLMP3100-GS08 | Pure green | 1.12 | 4 | - | 10 | 555 | 560 | 565 | 10 | - | 2.1 | 2.8 | 20 | GaP on GaP |
| VLMP3100-GS18 | Pure green | 1.12 | 4 | - | 10 | 555 | 560 | 565 | 10 | - | 2.1 | 2.8 | 20 | GaP on GaP |
| VLMP3101-GS08 | Pure green | 1.8 | 3.4 | 4.5 | 10 | 555 | 560 | 565 | 10 | - | 2.1 | 2.8 | 20 | GaP on GaP |
| VLMP3101-GS18 | Pure green | 1.8 | 3.4 | 4.5 | 10 | 555 | 560 | 565 | 10 | - | 2.1 | 2.8 | 20 | GaP on GaP |
| VLMP3102-GS08 | Pure green | 2.8 | 3.8 | 5.6 | 10 | 555 | 560 | 565 | 10 | - | 2.1 | 2.8 | 20 | GaP on GaP |
| VLMP3102-GS18 | Pure green | 2.8 | 3.8 | 5.6 | 10 | 555 | 560 | 565 | 10 | - | 2.1 | 2.8 | 20 | GaP on GaP |
| VLMP3107-GS08 | Pure green | 2.8 | 3.8 | 7.1 | 10 | 555 | 560 | 565 | 10 | - | 2.1 | 2.8 | 20 | GaP on GaP |
| VLMP3107-GS18 | Pure green | 2.8 | 3.8 | 7.1 | 10 | 555 | 560 | 565 | 10 | - | 2.1 | 2.8 | 20 | GaP on GaP |

| ABSOLUTE MAXIMUM RATINGS (T _{amb} = 25 °C, unless otherwise specified) VLMG310., VLMH310., VLMO310., VLMP310., VLMY310. | | | | |
|--|--|-------------------|-------------|------|
| PARAMETER | TEST CONDITION | SYMBOL | VALUE | UNIT |
| Reverse voltage | | V _R | 6 | V |
| DC forward current | T _{amb} ≤ 60 °C | I _F | 30 | mA |
| Surge forward current | t _p ≤ 10 μs | I _{FSM} | 0.5 | A |
| Power dissipation | T _{amb} ≤ 60 °C | P _V | 100 | mW |
| Junction temperature | | T _j | 100 | °C |
| Operating temperature range | | T _{amb} | -40 to +100 | °C |
| Storage temperature range | | T _{stg} | -40 to +100 | °C |
| Soldering temperature | t ≤ 5 s | T _{sd} | 260 | °C |
| Thermal resistance junction / ambient | Mounted on PC board (pad size > 16 mm ²) | R _{thJA} | 400 | K/W |

| OPTICAL AND ELECTRICAL CHARACTERISTICS (T _{amb} = 25 °C, unless otherwise specified) VLMH310., AMBER | | | | | | | |
|---|---------------------------------|----------|----------------|------|------|------|------|
| PARAMETER | TEST CONDITION | PART | SYMBOL | MIN. | TYP. | MAX. | UNIT |
| Luminous intensity ⁽¹⁾ | I _F = 10 mA | VLMH3100 | I _V | 2.8 | 10 | - | mcd |
| | | VLMH3101 | I _V | 4.5 | 8.7 | 11.2 | mcd |
| | | VLMH3102 | I _V | 7.1 | 10.3 | 18 | mcd |
| Dominant wavelength | I _F = 10 mA | | λ _d | 612 | 619 | 625 | nm |
| Peak wavelength | I _F = 10 mA | | λ _p | - | 635 | - | nm |
| Angle of half intensity | I _F = 10 mA | | φ | - | ± 60 | - | deg |
| Forward voltage | I _F = 20 mA | | V _F | - | 2 | 2.8 | V |
| Reverse voltage | I _R = 10 μA | | V _R | 6 | 15 | - | V |
| Junction capacitance | V _R = 0 V, f = 1 MHz | | C _j | - | 15 | - | pF |

Note

⁽¹⁾ In one packing unit I_{Vmax}/I_{Vmin} ≤ 1.6



VLMH310., VLMO310., VLMY310., VLMG310., VLMP310.
 www.vishay.com Vishay Semiconductors

| OPTICAL AND ELECTRICAL CHARACTERISTICS ($T_{amb} = 25\text{ }^{\circ}\text{C}$, unless otherwise specified) | | | | | | | |
|--|---|----------|-------------|------|----------|------|------|
| VLMO310., SOFT ORANGE | | | | | | | |
| PARAMETER | TEST CONDITION | PART | SYMBOL | MIN. | TYP. | MAX. | UNIT |
| Luminous intensity ⁽¹⁾ | $I_F = 10\text{ mA}$ | VLMO3100 | I_V | 2.8 | 8 | - | mcd |
| | | VLMO3101 | I_V | 4.5 | 8.6 | 11.2 | mcd |
| Dominant wavelength | $I_F = 10\text{ mA}$ | | λ_d | 598 | 605 | 611 | nm |
| Peak wavelength | $I_F = 10\text{ mA}$ | | λ_p | - | 605 | - | nm |
| Angle of half intensity | $I_F = 10\text{ mA}$ | | ϕ | - | ± 60 | - | deg |
| Forward voltage | $I_F = 20\text{ mA}$ | | V_F | - | 2 | 2.8 | V |
| Reverse voltage | $I_R = 10\text{ }\mu\text{A}$ | | V_R | 6 | 15 | - | V |
| Junction capacitance | $V_R = 0\text{ V}$, $f = 1\text{ MHz}$ | | C_j | - | 15 | - | pF |

Note

⁽¹⁾ In one packing unit $I_{Vmax}/I_{Vmin} \leq 1.6$

| OPTICAL AND ELECTRICAL CHARACTERISTICS ($T_{amb} = 25\text{ }^{\circ}\text{C}$, unless otherwise specified) | | | | | | | |
|--|---|----------|-------------|------|----------|------|------|
| VLMY310., YELLOW | | | | | | | |
| PARAMETER | TEST CONDITION | PART | SYMBOL | MIN. | TYP. | MAX. | UNIT |
| Luminous intensity ⁽¹⁾ | $I_F = 10\text{ mA}$ | VLMY3100 | I_V | 2.8 | 10 | - | mcd |
| | | VLMY3101 | I_V | 4.5 | 7.6 | 11.2 | mcd |
| | | VLMY3102 | I_V | 7.1 | 8.6 | 18 | mcd |
| Dominant wavelength | $I_F = 10\text{ mA}$ | | λ_d | 581 | 588 | 594 | nm |
| Peak wavelength | $I_F = 10\text{ mA}$ | | λ_p | - | 585 | - | nm |
| Angle of half intensity | $I_F = 10\text{ mA}$ | | ϕ | - | ± 60 | - | deg |
| Forward voltage | $I_F = 20\text{ mA}$ | | V_F | - | 2.1 | 2.8 | V |
| Reverse voltage | $I_R = 10\text{ }\mu\text{A}$ | | V_R | 6 | 15 | - | V |
| Junction capacitance | $V_R = 0\text{ V}$, $f = 1\text{ MHz}$ | | C_j | - | 15 | - | pF |

Note

⁽¹⁾ In one packing unit $I_{Vmax}/I_{Vmin} \leq 1.6$

| OPTICAL AND ELECTRICAL CHARACTERISTICS ($T_{amb} = 25\text{ }^{\circ}\text{C}$, unless otherwise specified) | | | | | | | |
|--|---|----------|-------------|------|----------|------|------|
| VLMG310., GREEN | | | | | | | |
| PARAMETER | TEST CONDITION | PART | SYMBOL | MIN. | TYP. | MAX. | UNIT |
| Luminous intensity ⁽¹⁾ | $I_F = 10\text{ mA}$ | VLMG3100 | I_V | 4.5 | 12 | - | mcd |
| | | VLMG3102 | I_V | 11.2 | 13.6 | 18 | mcd |
| | | VLMG3105 | I_V | 7.1 | 12 | 18 | mcd |
| Dominant wavelength | $I_F = 10\text{ mA}$ | | λ_d | 562 | 572 | 575 | nm |
| Peak wavelength | $I_F = 10\text{ mA}$ | | λ_p | - | 565 | - | nm |
| Angle of half intensity | $I_F = 10\text{ mA}$ | | ϕ | - | ± 60 | - | deg |
| Forward voltage | $I_F = 20\text{ mA}$ | | V_F | - | 2.2 | 2.8 | V |
| Reverse voltage | $I_R = 10\text{ }\mu\text{A}$ | | V_R | 6 | 15 | - | V |
| Junction capacitance | $V_R = 0\text{ V}$, $f = 1\text{ MHz}$ | | - | - | 15 | - | pF |

Note

⁽¹⁾ In one packing unit $I_{Vmax}/I_{Vmin} \leq 1.6$



VLMH310., VLMO310., VLMY310., VLMG310., VLMP310.
 www.vishay.com

Vishay Semiconductors

| OPTICAL AND ELECTRICAL CHARACTERISTICS (T _{amb} = 25 °C, unless otherwise specified) | | | | | | | |
|---|---------------------------------|----------|----------------|------|------|------|------|
| VLMP310., PURE GREEN | | | | | | | |
| PARAMETER | TEST CONDITION | PART | SYMBOL | MIN. | TYP. | MAX. | UNIT |
| Luminous intensity ⁽¹⁾ | I _F = 10 mA | VLMP3100 | I _V | 1.12 | 4 | - | mcd |
| | | VLMP3101 | I _V | 1.8 | 3.4 | 4.5 | mcd |
| | | VLMP3102 | I _V | 2.8 | 3.8 | 5.6 | mcd |
| | | VLMP3107 | I _V | 2.8 | 3.8 | 7.1 | mcd |
| Dominant wavelength | I _F = 10 mA | | λ _d | 555 | 560 | 565 | nm |
| Peak wavelength | I _F = 10 mA | | λ _p | - | 555 | - | nm |
| Angle of half intensity | I _F = 10 mA | | φ | - | ± 60 | - | deg |
| Forward voltage | I _F = 20 mA | | V _F | - | 2.1 | 2.8 | V |
| Reverse voltage | I _R = 10 μA | | V _R | 6 | 15 | - | V |
| Junction capacitance | V _R = 0 V, f = 1 MHz | | C _j | - | 15 | - | pF |

Note

⁽¹⁾ In one packing unit I_{Vmax}/I_{Vmin} ≤ 1.6

| COLOR CALSSIFICATION | | | | | | | | |
|----------------------|----------------------|------|-------|------|----------------------|------|------------|------|
| GROUP | YELLOW | | GREEN | | SOFT ORANGE | | PURE GREEN | |
| | DOM. WAVELENGTH (nm) | | | | DOM. WAVELENGTH (nm) | | | |
| | MIN. | MAX. | MIN. | MAX. | MIN. | MAX. | MIN. | MAX. |
| 0 | - | - | - | - | - | - | 555 | 559 |
| 1 | 581 | 584 | - | - | 598 | 601 | 558 | 561 |
| 2 | 583 | 586 | - | - | 600 | 603 | 560 | 563 |
| 3 | 585 | 588 | - | - | 602 | 605 | 562 | 565 |
| 4 | 587 | 590 | 564 | 567 | 604 | 607 | - | - |
| 5 | 589 | 592 | 566 | 569 | 606 | 609 | - | - |
| 6 | 591 | 594 | 568 | 571 | 608 | 611 | - | - |
| 7 | - | - | 570 | 573 | - | - | - | - |
| 8 | - | - | 572 | 575 | - | - | - | - |

Note

• Wavelengths are tested at a current pulse duration of 25 ms.

| LUMINOUS INTENSITY CLASSIFICATION | | | |
|-----------------------------------|-----------------------|----------|-------|
| GROUP | LIGHT INTENSITY (mcd) | | |
| | STANDARD | OPTIONAL | MAX. |
| F | 1 | 1.12 | 1.40 |
| | 2 | 1.40 | 1.80 |
| G | 1 | 1.80 | 2.24 |
| | 2 | 2.24 | 2.80 |
| H | 1 | 2.80 | 3.55 |
| | 2 | 3.55 | 4.50 |
| J | 1 | 4.50 | 5.60 |
| | 2 | 5.60 | 7.10 |
| K | 1 | 7.10 | 9.00 |
| | 2 | 9.00 | 11.20 |
| L | 1 | 11.20 | 14.00 |
| | 2 | 14.00 | 18.00 |
| M | 1 | 18.00 | 22.40 |
| | 2 | 22.40 | 28.00 |

Note

• Luminous intensity is tested at a current pulse duration of 25 ms and an accuracy of ± 11 %.
 The above type numbers represent the order groups which include only a few brightness groups. Only one group will be shipped on each reel (there will be no mixing of two groups on each reel).
 In order to ensure availability, single brightness groups will not be orderable.
 In a similar manner for colors where wavelength groups are measured and binned, single wavelength groups will be shipped on any one reel.
 In order to ensure availability, single wavelength groups will not be orderable.



VLMH310., VLMO310., VLMY310., VLMG310., VLMP310.
 www.vishay.com
 Vishay Semiconductors

| CROSSING TABLE | | |
|----------------|------------|-----------|
| VISHAY | OSRAM | STANLEY |
| VLMH3100 | - | - |
| VLMH3101 | - | - |
| VLMH3102 | - | - |
| VLMO3100 | LOT670J1L2 | - |
| VLMO3101 | LOT670J1K2 | - |
| VLMY3100 | LYT670J1L2 | - |
| VLMY3101 | LYT670J1K2 | - |
| VLMY3102 | LYT670K1L2 | - |
| VLMG3100 | LGT670K1M2 | VYBG1104B |
| VLMG3102 | LGT670L1L2 | - |
| VLMG3105 | LGT671K1L2 | - |
| VLMP3100 | LPT670F2J2 | - |
| VLMP3101 | LPT670G1H2 | VYBG1101W |
| VLMP3102 | LPT670H1J2 | - |
| VLMP3107 | LPT670H1J1 | - |

TYPICAL CHARACTERISTICS ($T_{amb} = 25\text{ }^{\circ}\text{C}$, unless otherwise specified)

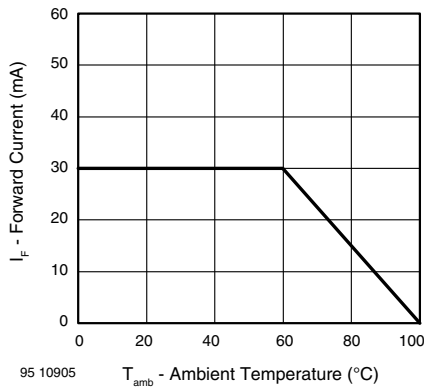

Fig. 1 - Maximum Permissible Forward Current vs. Ambient Temperature

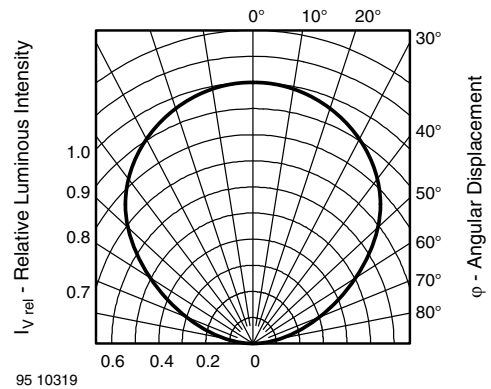

Fig. 3 - Relative Luminous Intensity vs. Angular Displacement

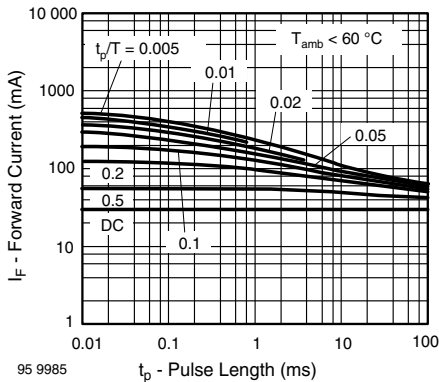

Fig. 2 - Permissible Pulse Forward Current vs. Pulse Duration

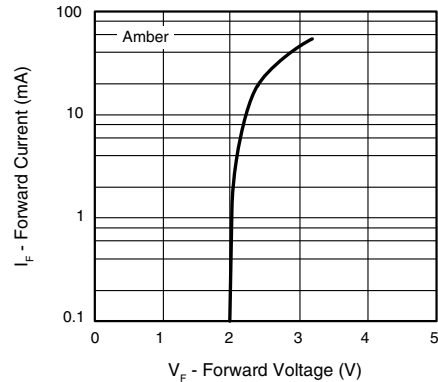

Fig. 4 - Forward Current vs. Forward Voltage



VLMH310., VLMO310., VLMY310., VLMG310., VLMP310.
 www.vishay.com
 Vishay Semiconductors

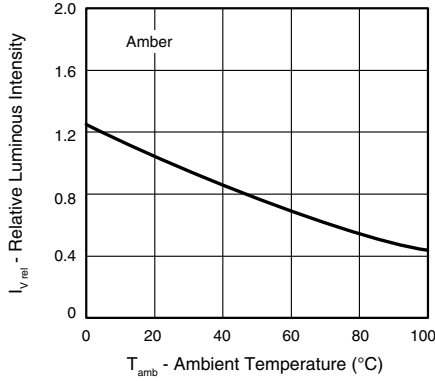

Fig. 5 - Relative Luminous Intensity vs. Ambient Temperature

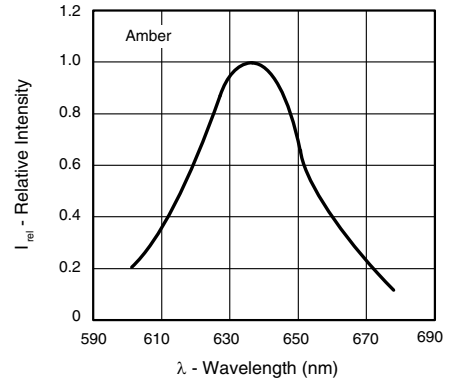

Fig. 8 - Relative Intensity vs. Wavelength

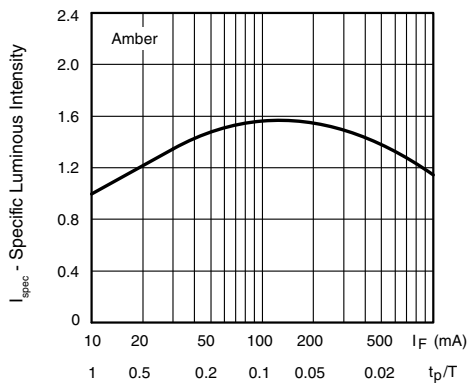

Fig. 6 - Specific Luminous Intensity vs. Forward Current/Duty Cycle

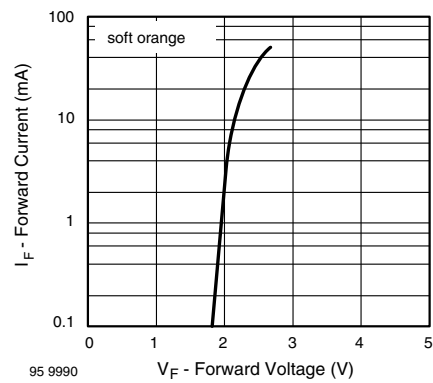

Fig. 9 - Forward Current vs. Forward Voltage

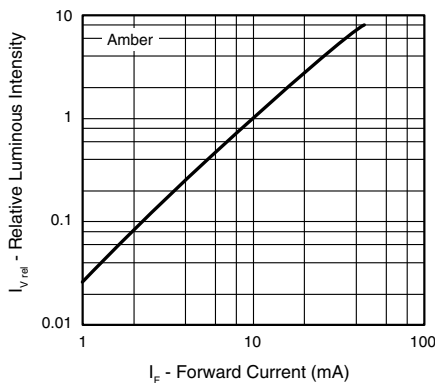

Fig. 7 - Relative Luminous Intensity vs. Forward Current

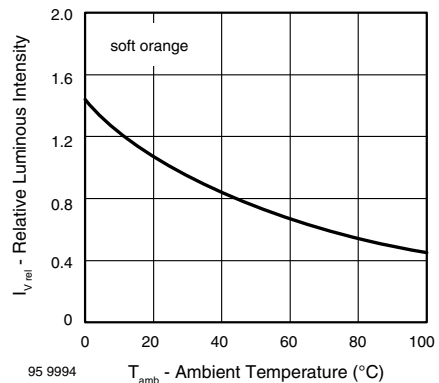

Fig. 10 - Relative Luminous Intensity vs. Ambient Temperature



VLMH310., VLMO310., VLMY310., VLMG310., VLMP310.
 www.vishay.com
 Vishay Semiconductors

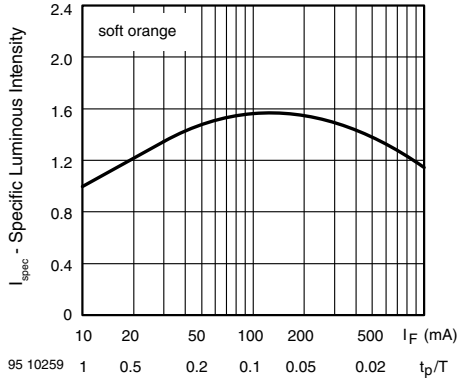

Fig. 11 - Specific Luminous Intensity vs. Forward Current/Duty Cycle

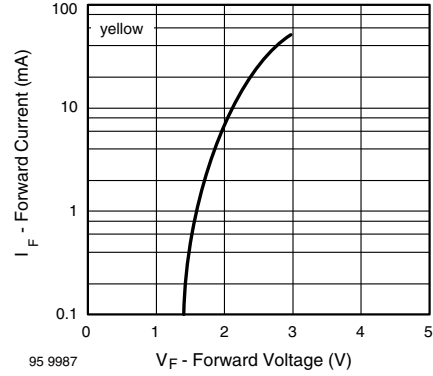

Fig. 14 - Forward Current vs. Forward Voltage

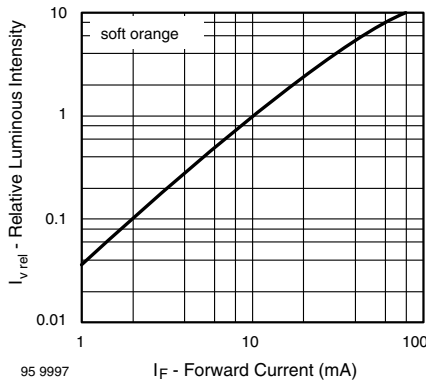

Fig. 12 - Relative Luminous Intensity vs. Forward Current

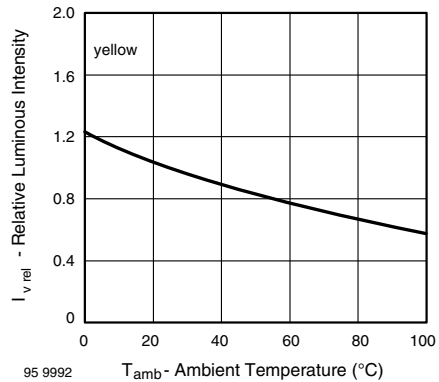

Fig. 15 - Relative Luminous Intensity vs. Ambient Temperature

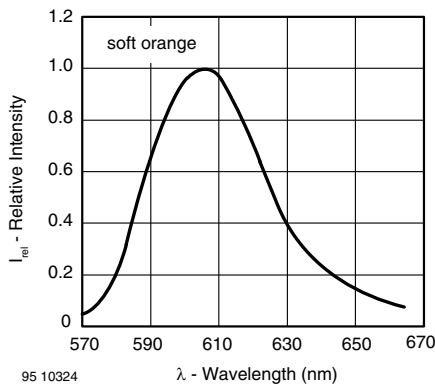

Fig. 13 - Relative Intensity vs. Wavelength

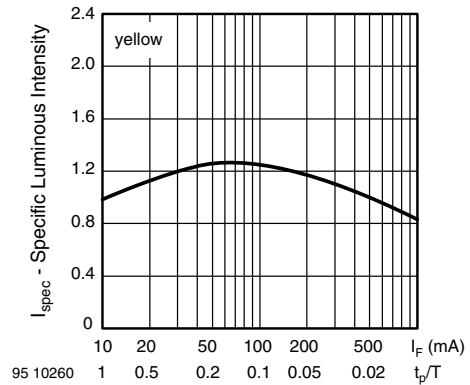

Fig. 16 - Specific Luminous Intensity vs. Forward Current/Duty Cycle



VLMH310., VLMO310., VLMY310., VLMG310., VLMP310.
 www.vishay.com
 Vishay Semiconductors

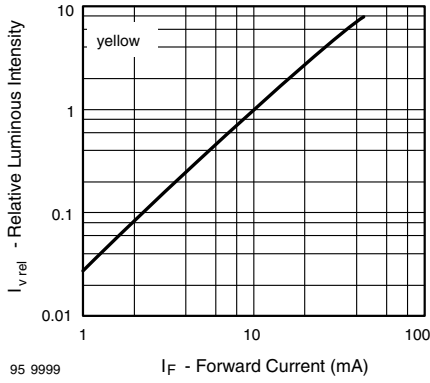

Fig. 17 - Relative Luminous Intensity vs. Forward Current

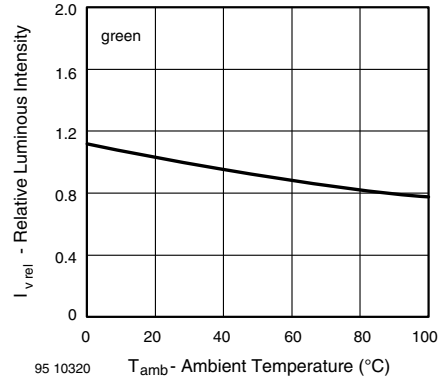

Fig. 20 - Relative Luminous Intensity vs. Ambient Temperature

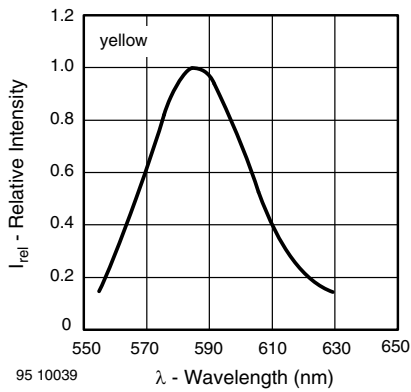

Fig. 18 - Relative Intensity vs. Wavelength

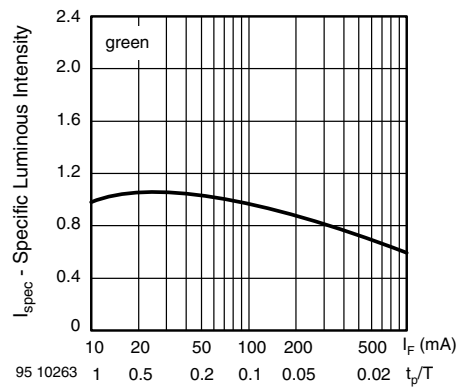

Fig. 21 - Specific Luminous Intensity vs. Forward Current

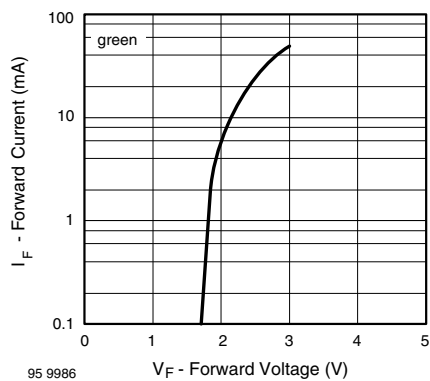

Fig. 19 - Forward Current vs. Forward Voltage

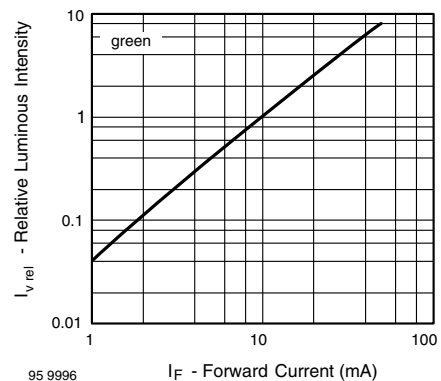

Fig. 22 - Relative Luminous Intensity vs. Forward Current



VLMH310., VLMO310., VLMY310., VLMG310., VLMP310.

www.vishay.com

Vishay Semiconductors

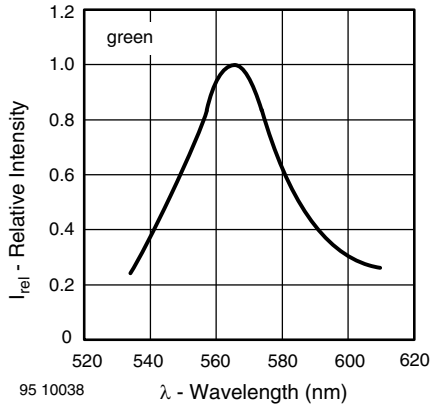

Fig. 23 - Relative Intensity vs. Wavelength

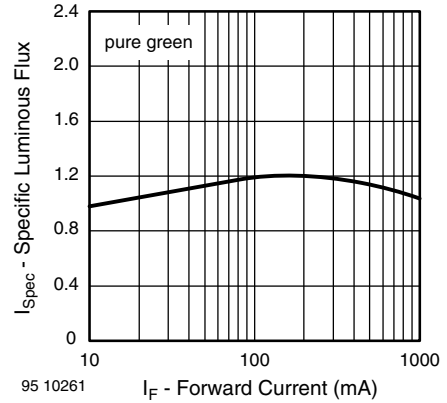

Fig. 26 - Specific Luminous Intensity vs. Forward Current

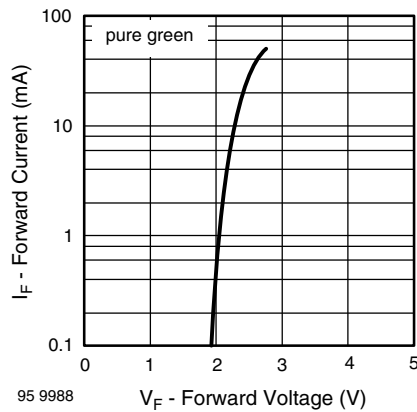

Fig. 24 - Forward Current vs. Forward Voltage

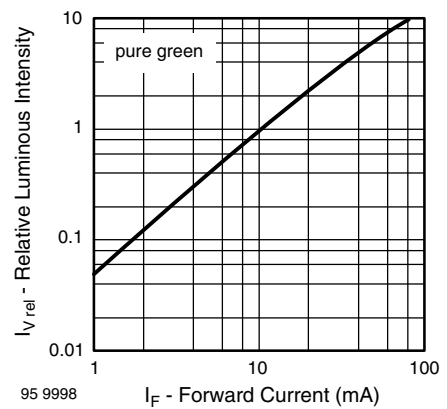

Fig. 27 - Relative Luminous Intensity vs. Forward Current

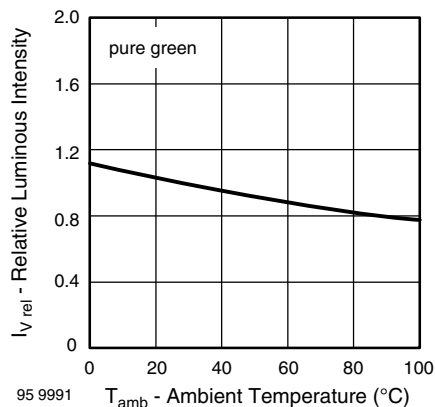

Fig. 25 - Relative Luminous Intensity vs. Ambient Temperature

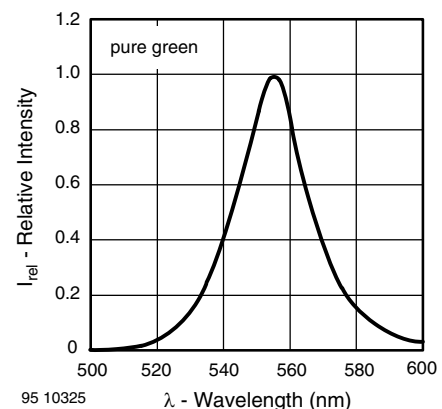

Fig. 28 - Relative Intensity vs. Wavelength



VLMH310., VLMO310., VLMY310., VLMG310., VLMP310.

www.vishay.com

Vishay Semiconductors

PACKAGE DIMENSIONS in millimeters

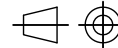
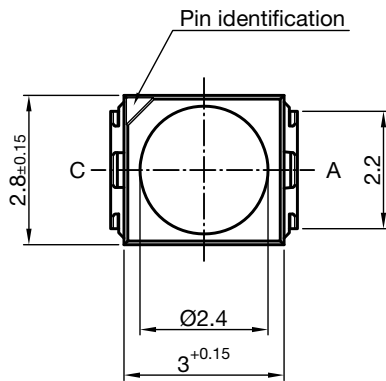
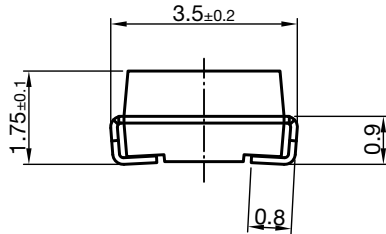

Technical drawings according to DIN specifications

Dimensions in mm

Drawing-No.: 6.541-5067.01-4
Issue: 6; 23.09.13

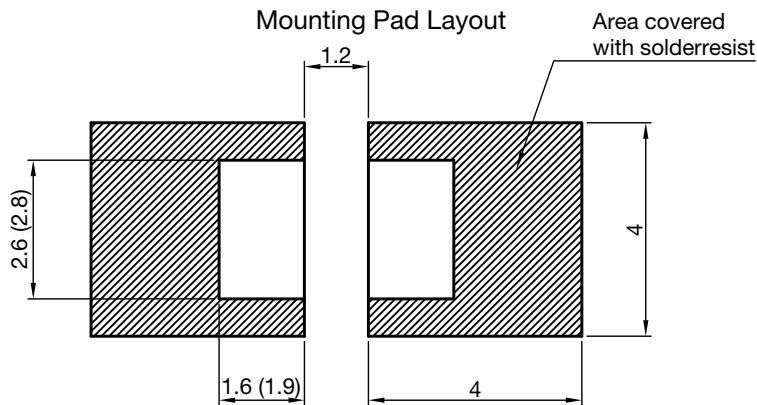

Dimensions: Reflow and vapor phase (wave soldering)



VLMH310., VLMO310., VLMY310., VLMG310., VLMP310.
 www.vishay.com
 Vishay Semiconductors

METHOD OF TAPING / POLARITY AND TAPE AND REEL

SMD LED (VLM.3-SERIES)

Vishay's LEDs in SMD packages are available in an antistatic 8 mm blister tape (in accordance with DIN IEC 40 (CO) 564) for automatic component insertion. The blister tape is a plastic strip with impressed component cavities, covered by a top tape.

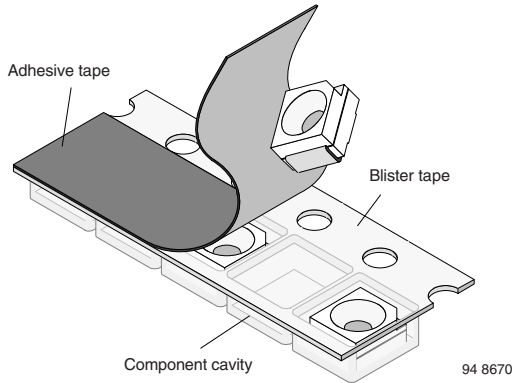

REEL PACKAGE DIMENSION IN MILLIMETERS FOR SMD LEDS, TAPE OPTION GS18 (= 8000 PCS.) PREFERRED

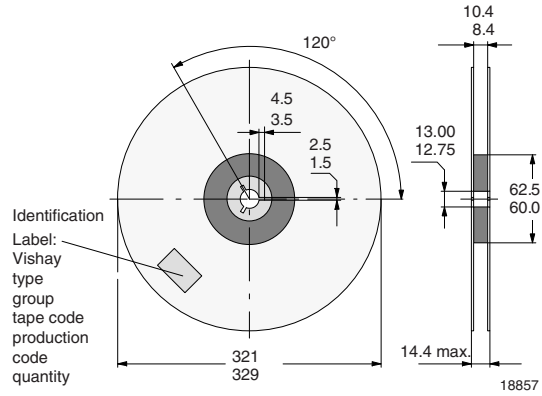

Fig. 31 - Reel Dimensions - GS18

TAPING OF VLM.3...

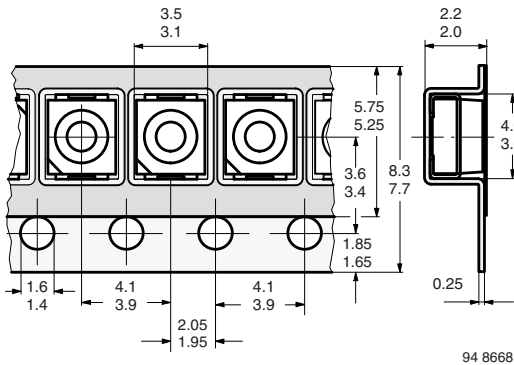

Fig. 29 - Tape Dimensions in mm for PLCC-2

SOLDERING PROFILE

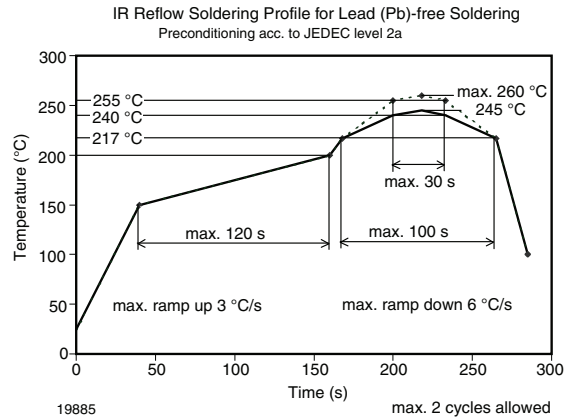

Fig. 32 - Vishay Lead (Pb)-free Reflow Soldering Profile (acc. to J-STD-020)

REEL PACKAGE DIMENSION IN MILLIMETERS FOR SMD LEDS, TAPE OPTION GS08 (= 1500 PCS.)

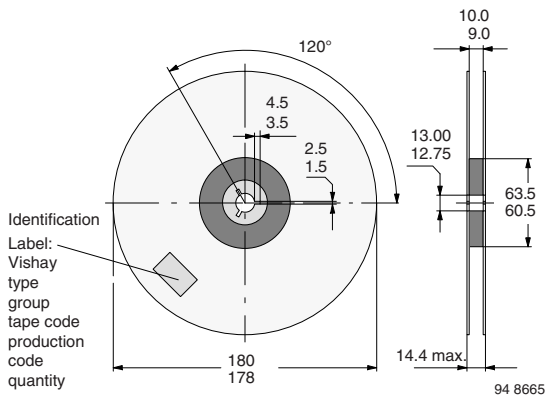

Fig. 30 - Reel Dimensions - GS08

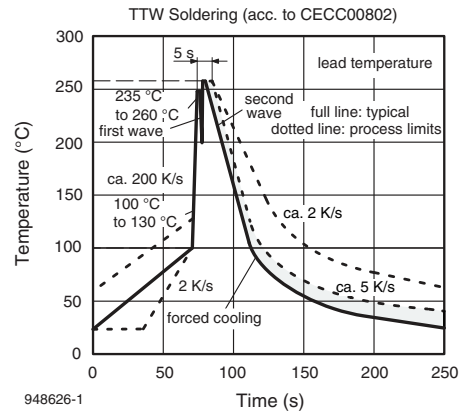

Fig. 33 - Double Wave Soldering of Opto Devices (all Packages)



VLMH310., VLMO310., VLMY310., VLMG310., VLMP310.

www.vishay.com

Vishay Semiconductors

BAR CODE PRODUCT LABEL (example)

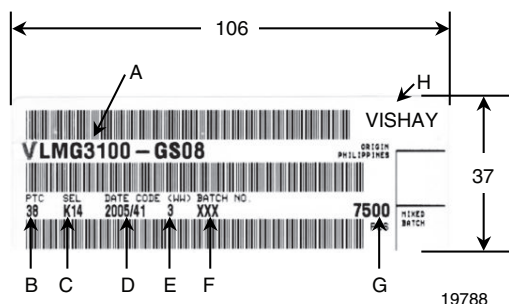

- A. Type of component
- B. Manufacturing plant
- C. SEL - selection code (bin):
e.g.: K1 = code for luminous intensity group
4 = code for color group
- D. Date code year / week
- E. Day code (e.g. 2: Tuesday)
- F. Batch no.
- G. Total quantity
- H. Company code

DRY PACKING

The reel is packed in an anti-humidity bag to protect the devices from absorbing moisture during transportation and storage.

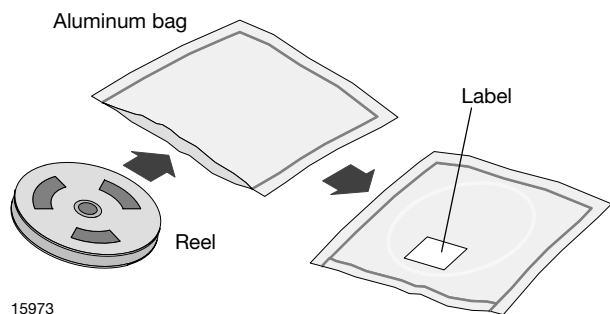

FINAL PACKING

The sealed reel is packed into a cardboard box. A secondary cardboard box is used for shipping purposes.

RECOMMENDED METHOD OF STORAGE

Dry box storage is recommended as soon as the aluminum bag has been opened to prevent moisture absorption. The following conditions should be observed, if dry boxes are not available:

- Storage temperature 10 °C to 30 °C
- Storage humidity ≤ 60 % RH max.

After more than 672 h under these conditions moisture content will be too high for reflow soldering.

In case of moisture absorption, the devices will recover to the former condition by drying under the following condition:

- 192 h at 40 °C + 5 °C / - 0 °C and < 5 % RH (dry air / nitrogen) or
- 96 h at 60 °C + 5 °C and < 5 % RH for all device containers or
- 24 h at 100 °C + 5 °C not suitable for reel or tubes.

An EIA JEDEC standard JESD22-A112 level 2a label is included on all dry bags.

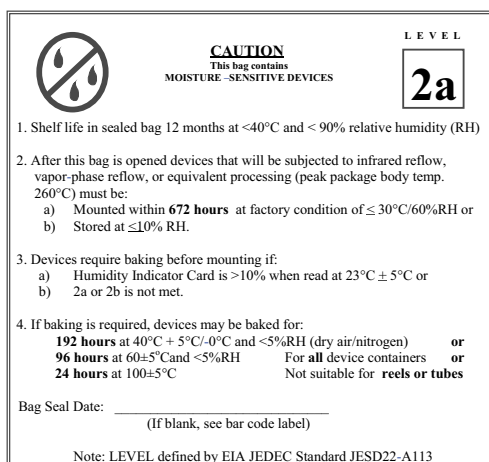

Example of JESD22-A112 level 2a label

ESD PRECAUTION

Proper storage and handling procedures should be followed to prevent ESD damage to the devices especially when they are removed from the antistatic shielding bag. Electrostatic sensitive devices warning labels are on the packaging.

VISHAY SEMICONDUCTORS STANDARD BAR CODE LABEL

The Vishay Semiconductors standard bar code labels are printed at final packing areas. The labels are on each packing unit and contain Vishay Semiconductors specific data.



Disclaimer

ALL PRODUCT, PRODUCT SPECIFICATIONS AND DATA ARE SUBJECT TO CHANGE WITHOUT NOTICE TO IMPROVE RELIABILITY, FUNCTION OR DESIGN OR OTHERWISE.

Vishay Intertechnology, Inc., its affiliates, agents, and employees, and all persons acting on its or their behalf (collectively, "Vishay"), disclaim any and all liability for any errors, inaccuracies or incompleteness contained in any datasheet or in any other disclosure relating to any product.

Vishay makes no warranty, representation or guarantee regarding the suitability of the products for any particular purpose or the continuing production of any product. To the maximum extent permitted by applicable law, Vishay disclaims (i) any and all liability arising out of the application or use of any product, (ii) any and all liability, including without limitation special, consequential or incidental damages, and (iii) any and all implied warranties, including warranties of fitness for particular purpose, non-infringement and merchantability.

Statements regarding the suitability of products for certain types of applications are based on Vishay's knowledge of typical requirements that are often placed on Vishay products in generic applications. Such statements are not binding statements about the suitability of products for a particular application. It is the customer's responsibility to validate that a particular product with the properties described in the product specification is suitable for use in a particular application. Parameters provided in datasheets and / or specifications may vary in different applications and performance may vary over time. All operating parameters, including typical parameters, must be validated for each customer application by the customer's technical experts. Product specifications do not expand or otherwise modify Vishay's terms and conditions of purchase, including but not limited to the warranty expressed therein.

Except as expressly indicated in writing, Vishay products are not designed for use in medical, life-saving, or life-sustaining applications or for any other application in which the failure of the Vishay product could result in personal injury or death. Customers using or selling Vishay products not expressly indicated for use in such applications do so at their own risk. Please contact authorized Vishay personnel to obtain written terms and conditions regarding products designed for such applications.

No license, express or implied, by estoppel or otherwise, to any intellectual property rights is granted by this document or by any conduct of Vishay. Product names and markings noted herein may be trademarks of their respective owners.