

## Excellent Integrated System Limited

Stocking Distributor

Click to view price, real time Inventory, Delivery & Lifecycle Information:

[IXYS Corporation](#)

[DSA70C100HB](#)

For any questions, you can email us directly:

[sales@integrated-circuit.com](mailto:sales@integrated-circuit.com)

## Schottky Diode Gen<sup>2</sup>

$$V_{RRM} = 100V$$

$$I_{FAV} = 2 \times 35A$$

$$V_F = 0.74V$$

High Performance Schottky Diode

Low Loss and Soft Recovery

Common Cathode

Part number

**DSA70C100HB**

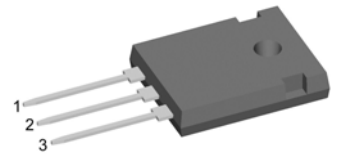

Backside: cathode

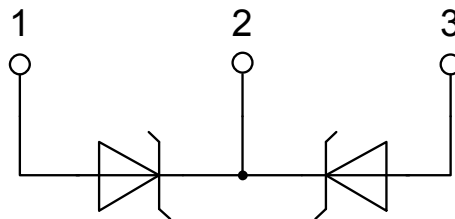

### Features / Advantages:

- Very low  $V_f$
- Extremely low switching losses
- Low  $I_{rm}$  values
- Improved thermal behaviour
- High reliability circuit operation
- Low voltage peaks for reduced protection circuits
- Low noise switching

### Applications:

- Rectifiers in switch mode power supplies (SMPS)
- Free wheeling diode in low voltage converters

### Package: TO-247

- Industry standard outline
- RoHS compliant
- Epoxy meets UL 94V-0

Schottky				Ratings		
Symbol	Definition	Conditions	min.	typ.	max.	Unit
$V_{RSM}$	max. non-repetitive reverse blocking voltage				100	V
$V_{RRM}$	max. repetitive reverse blocking voltage				100	V
$I_R$	reverse current, drain current	$V_R = 100\text{ V}$	$T_{VJ} = 25^\circ\text{C}$		680	$\mu\text{A}$
		$V_R = 100\text{ V}$	$T_{VJ} = 125^\circ\text{C}$		7.5	mA
$V_F$	forward voltage drop	$I_F = 35\text{ A}$	$T_{VJ} = 25^\circ\text{C}$		0.92	V
					1.10	V
		$I_F = 70\text{ A}$	$T_{VJ} = 125^\circ\text{C}$		0.74	V
					0.95	V
$I_{FAV}$	average forward current	$T_C = 150^\circ\text{C}$ rectangular $d = 0.5$	$T_{VJ} = 175^\circ\text{C}$		35	A
$V_{F0}$	threshold voltage	} for power loss calculation only	$T_{VJ} = 175^\circ\text{C}$		0.45	V
$r_F$	slope resistance				6	m $\Omega$
$R_{thJC}$	thermal resistance junction to case				0.7	K/W
$R_{thCH}$	thermal resistance case to heatsink			0.25		K/W
$P_{tot}$	total power dissipation		$T_C = 25^\circ\text{C}$		160	W
$I_{FSM}$	max. forward surge current	$t = 10\text{ ms}; (50\text{ Hz}), \text{ sine}; V_R = 0\text{ V}$	$T_{VJ} = 45^\circ\text{C}$		550	A
$C_J$	junction capacitance	$V_R = 12\text{ V}$ $f = 1\text{ MHz}$	$T_{VJ} = 25^\circ\text{C}$		406	pF



# DSA70C100HB

Package TO-247			Ratings			
Symbol	Definition	Conditions	min.	typ.	max.	Unit
$I_{RMS}$	RMS current	per terminal <sup>1)</sup>			50	A
$T_{VJ}$	virtual junction temperature		-55		175	°C
$T_{op}$	operation temperature		-55		150	°C
$T_{stg}$	storage temperature		-55		150	°C
<b>Weight</b>				6		g
$M_D$	mounting torque		0.8		1.2	Nm
$F_C$	mounting force with clip		20		120	N

### Product Marking

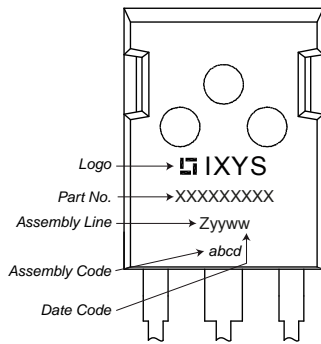

### Part number

- D = Diode
- S = Schottky Diode
- A = low VF
- 70 = Current Rating [A]
- C = Common Cathode
- 100 = Reverse Voltage [V]
- HB = TO-247AD (3)

Ordering	Part Number	Marking on Product	Delivery Mode	Quantity	Code No.
Standard	DSA70C100HB	DSA70C100HB	Tube	30	502788

Similar Part	Package	Voltage class
DSA80C100PB	TO-220AB (3)	100

### Equivalent Circuits for Simulation

\* on die level

$T_{VJ} = 175\text{ °C}$

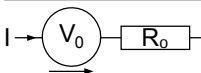

Schottky

$V_{0\ max}$	threshold voltage	0.45	V
$R_{0\ max}$	slope resistance *	3.4	mΩ

**Outlines TO-247**

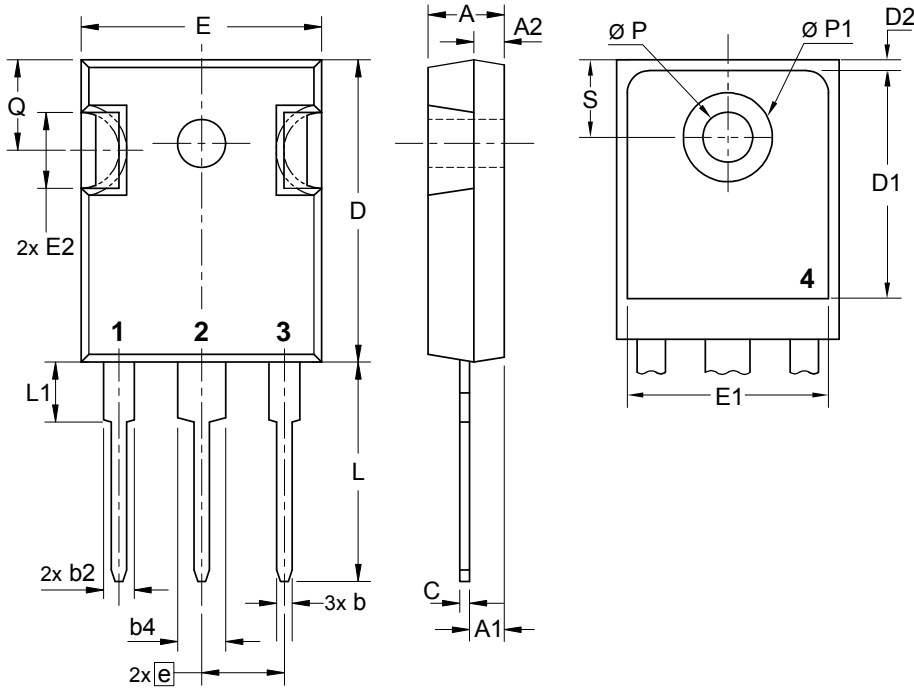

Sym.	Inches		Millimeter	
	min.	max.	min.	max.
A	0.185	0.209	4.70	5.30
A1	0.087	0.102	2.21	2.59
A2	0.059	0.098	1.50	2.49
D	0.819	0.845	20.79	21.45
E	0.610	0.640	15.48	16.24
E2	0.170	0.216	4.31	5.48
e	0.215 BSC		5.46 BSC	
L	0.780	0.800	19.80	20.30
L1	-	0.177	-	4.49
Ø P	0.140	0.144	3.55	3.65
Q	0.212	0.244	5.38	6.19
S	0.242 BSC		6.14 BSC	
b	0.039	0.055	0.99	1.40
b2	0.065	0.094	1.65	2.39
b4	0.102	0.135	2.59	3.43
c	0.015	0.035	0.38	0.89
D1	0.515	-	13.07	-
D2	0.020	0.053	0.51	1.35
E1	0.530	-	13.45	-
Ø P1	-	0.29	-	7.39

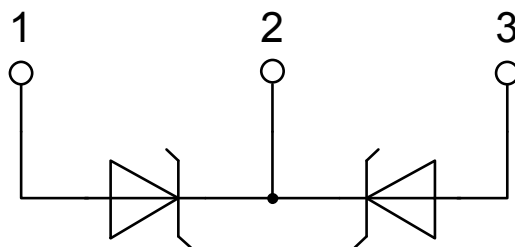

**Schottky**

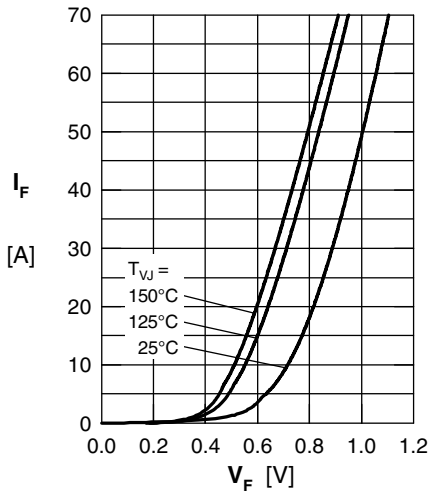

Fig. 1 Maximum forward voltage drop characteristics

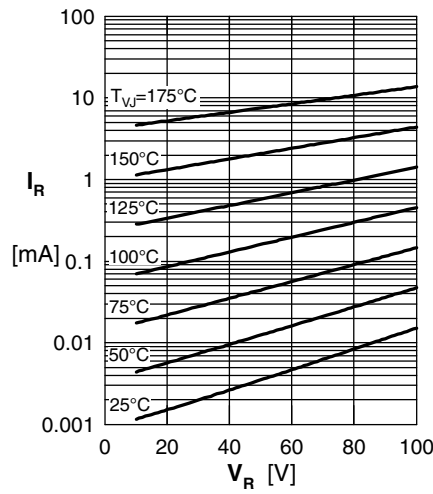

Fig. 2 Typ. reverse current  $I_R$  vs. reverse voltage  $V_R$

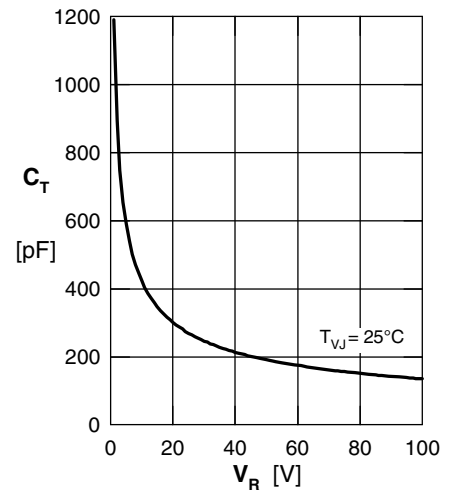

Fig. 3 Typ. junction capacitance  $C_T$  vs. reverse voltage  $V_R$

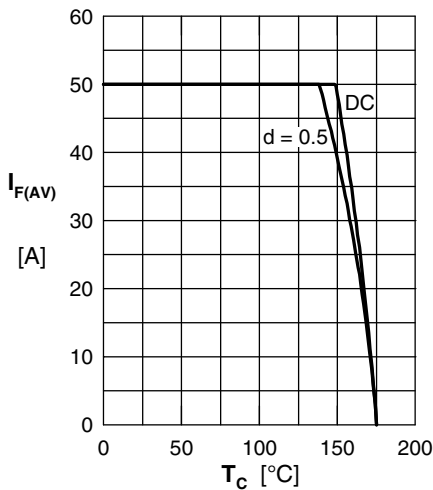

Fig. 4 Average forward current  $I_{F(AV)}$  vs. case temperature  $T_C$

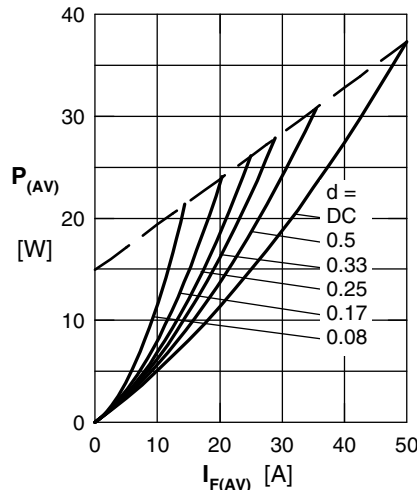

Fig. 5 Forward power loss characteristics

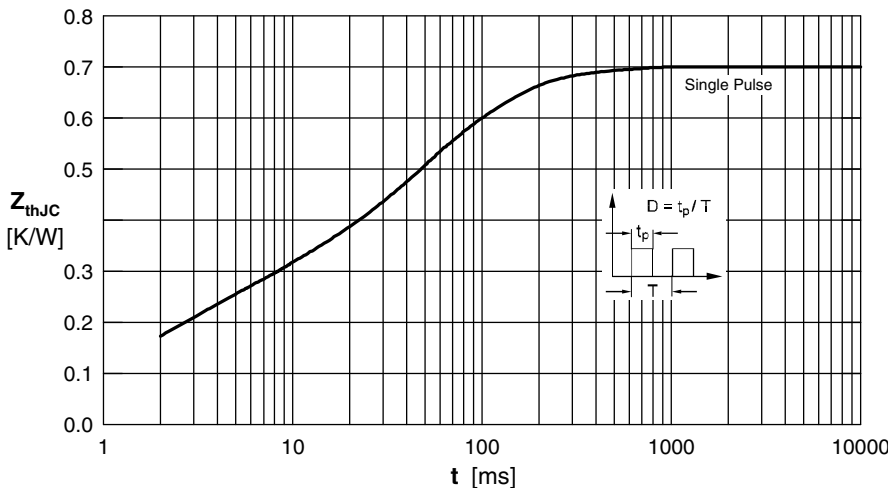

Fig. 6 Transient thermal impedance junction to case

Note: All curves are per diode