



Distributor of Infineon Technologies: Excellent Integrated System Limited
Datasheet of TLE4240-2M - IC LED Driver Linear 58mA PG-SCT595-5

Contact us: sales@integrated-circuit.com Website: www.integrated-circuit.com

Excellent Integrated System Limited

Stocking Distributor

Click to view price, real time Inventory, Delivery & Lifecycle Information:

[Infineon Technologies](#)
[TLE4240-2M](#)

For any questions, you can email us directly:

sales@integrated-circuit.com



Low Dropout Linear LED Driver

TLE 4240-2/3 M



Features

- Typ. 58 mA constant output current
- Low dropout voltage
- Tiny SMD package PG-SCT595-5
- Open load detection (Version TLE 4240-3 M only)
- 45 V input voltage operation range
- Safe operation area monitoring
- Output protected against short circuit to GND and supply
- Reverse polarity protection
- Wide temperature range: $-40\text{ °C} \leq T_j \leq 150\text{ °C}$
- Overtemperature shutdown
- Suitable for use in automotive electronics

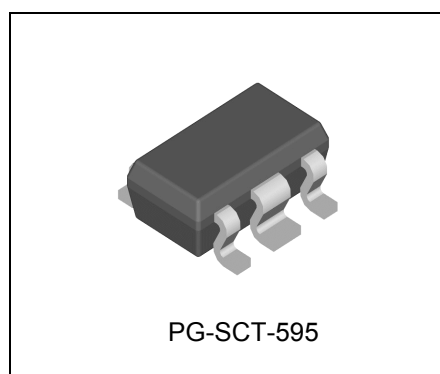

Functional Description

The TLE 4240-2/3 M is a monolithic integrated low dropout linear constant current source. It is designed to supply white or color LEDs in order to achieve constant brightness and extended LED lifetime independent from supply voltage or LED forward voltage class.

Protection circuits prevent from damage to the device in case of overload, short circuit, reverse polarity and overheat. The LEDs connected are protected against reverse polarity transients as well as against voltages up to 45 V. The Safe Operation Area (SOA) monitoring function limits the output current in case of a very high drop voltage across the regulator. For details see graph "Output Current versus Drop Voltage".

Version TLE 4240-3 M is equipped with a status output indicating an open load failure condition.

The TLE 4240-2/3 M is supplied in a space-saving PG-SCT595-5 package offering minimal thermal resistance.

Type	Package	Remark	Marking
TLE 4240-2 M	PG-SCT595-5	–	42
TLE 4240-3 M	PG-SCT595-5	Open load detection	43



TLE 4240-2/3 M

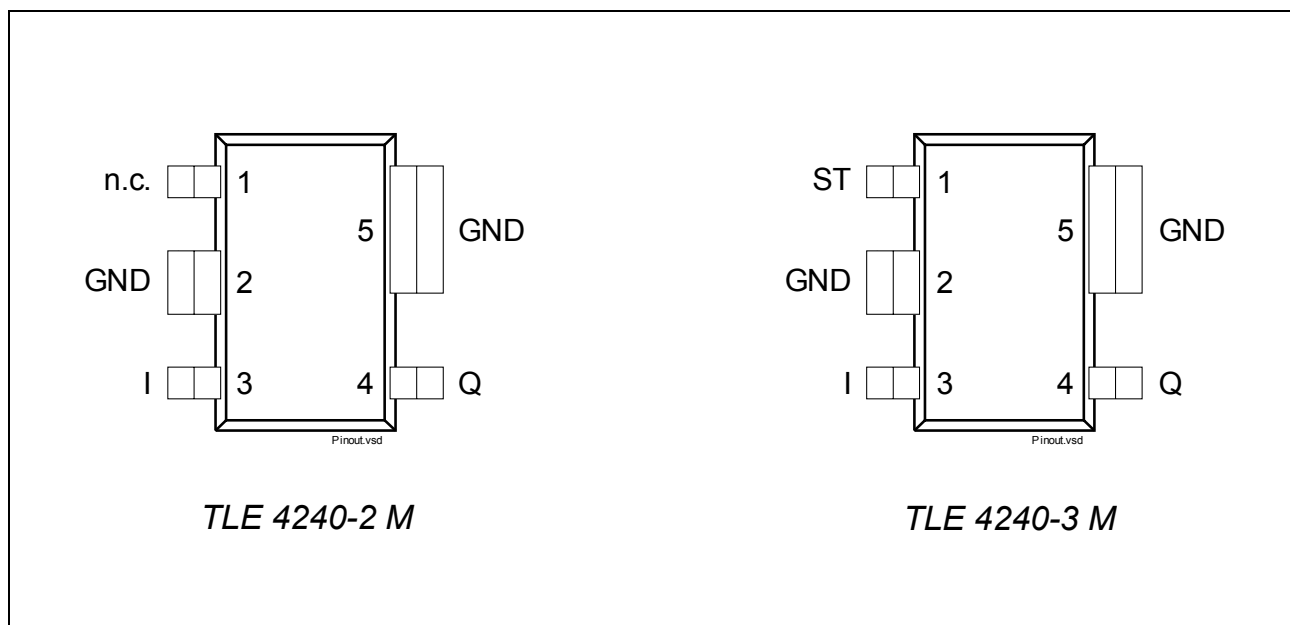

Figure 1 Pin Configuration (top view)

Table 1 Pin Definitions and Functions

Pin No.	Symbol	Function
1	n.c.	<i>Version TLE 4240-2 M only:</i> Internally not connected.
1	ST	<i>Version TLE 4240-3 M only:</i> Status output ; open collector output. Low level indicates open load. Connect to a positive voltage rail with an external pull-up resistor. Leave open, if not needed.
2	GND	Ground ; connect to heatsink area. Interconnect with pin 5.
3	I	Input ; IC supply
4	Q	Output ;
5	GND	Ground ; connect to heatsink area. Interconnect with pin 2.

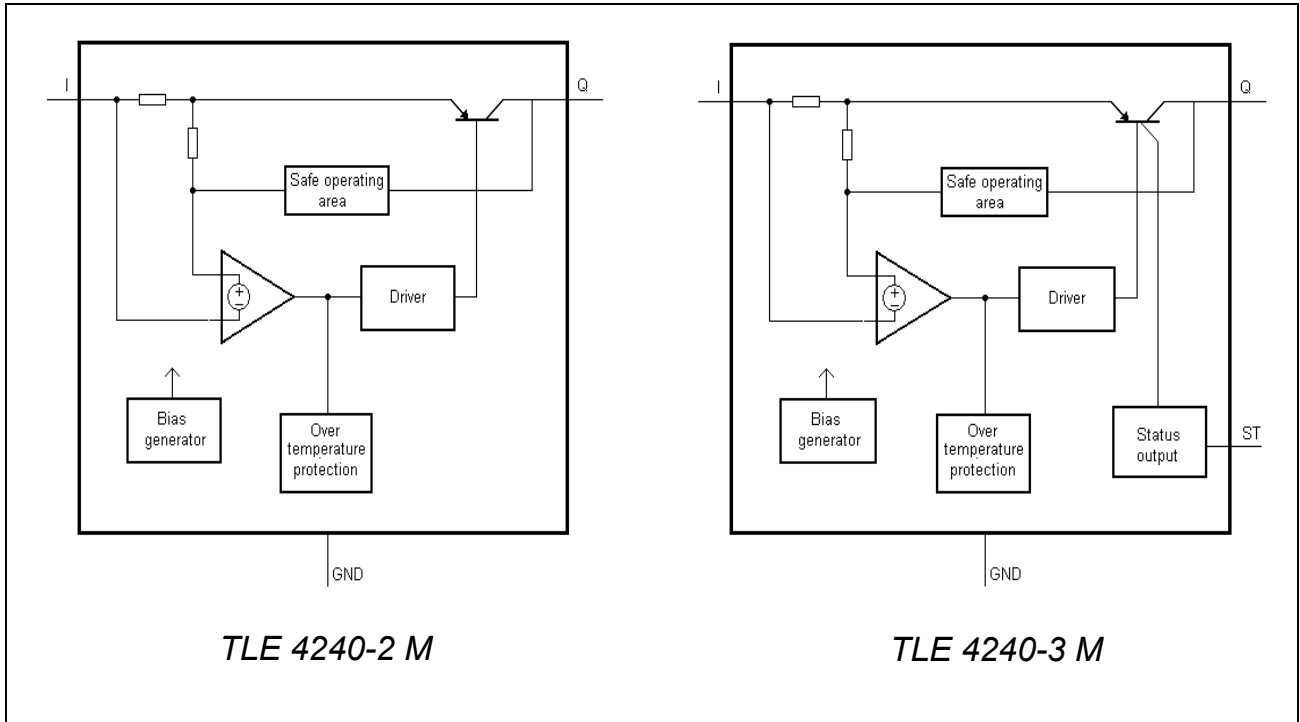

Figure 2 Block Diagram

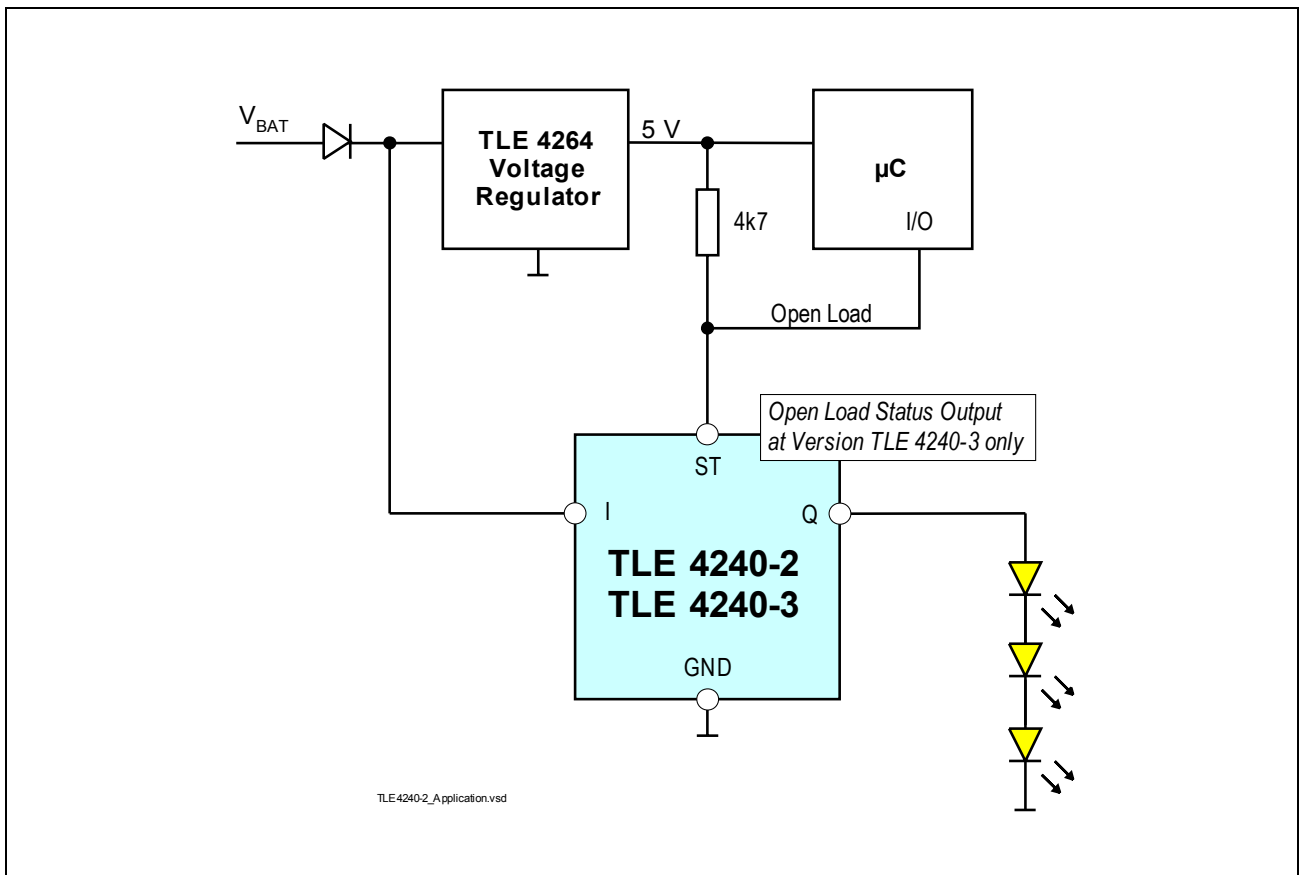

Figure 3 Typical Application Circuit



Table 2 Absolute Maximum Ratings

$-40\text{ °C} \leq T_j \leq 150\text{ °C}$

Parameter	Symbol	Limit Values		Unit	Remarks
		Min.	Max.		
Input I					
Voltage	V_I	-16	45	V	–
Current	I_I	–	–	mA	internally limited
Output Q					
Voltage	V_Q	-1	40	V	–
Current	I_Q	–	–	mA	internally limited
Status ST (TLE 4240-3 M)					
Voltage	V_{ST}	-0.3	12	V	–
Current	I_{ST}	–	–	mA	internally limited
ESD Susceptibility					
ESD Resistivity	$V_{ESD,HBM}$	4	–	kV	TLE 4240-2 M; HBM ¹⁾
	$V_{ESD,CDM}$	2	–	kV	TLE 4240-2 M; CDM ²⁾
ESD Resistivity	$V_{ESD,HBM}$	2	–	kV	TLE 4240-3 M; HBM ¹⁾
	$V_{ESD,CDM}$	2	–	kV	TLE 4240-3 M; CDM ²⁾
Temperatures					
Junction temperature	T_j	-40	150	°C	–
Storage temperature	T_{stg}	-50	150	°C	–

1) ESD susceptibility “human body model (HBM)” according to JESD22-A114.

2) ESD susceptibility “charged device model (CDM)” according to JESD22-C101

Note: Stresses above the ones listed here may cause permanent damage to the device. Exposure to absolute maximum rating conditions for extended periods may affect device reliability.

Integrated protection functions are designed to prevent IC destruction under fault conditions described in the data sheet. Fault conditions are considered as “outside” normal operating range. Protection functions are not designed for continuous repetitive operation.



TLE 4240-2/3 M

Table 3 Functional Range

Parameter	Symbol	Limit Values		Unit	Remarks
		Min.	Max.		
Input voltage	V_I	3	45	V	–
Status output voltage (Version TLE 4240-3 M only)	V_{ST}	–	15	V	–
Junction temperature	T_j	-40	150	°C	–

Table 4 Thermal Resistance

Parameter	Symbol	Typ. Limit Values	Unit	Remarks
Junction ambient	$R_{th,j-a}$	179	K/W	A: footprint only ¹⁾
		99	K/W	A = 300 mm ¹⁾
		87	K/W	A = 600 mm ¹⁾
Junction pin 5	$R_{th,j-pin5}$	26	K/W	measured to pin 5

1) Mounted on a PCB 80 × 80 × 1.5 mm³, horizontal position, zero airflow.

Table 5 Electrical Characteristics

$V_I = 13.5\text{ V}$; $V_Q = 6\text{ V}$; $-40\text{ °C} \leq T_j \leq 150\text{ °C}$; unless otherwise specified

Parameter	Symbol	Limit Values			Unit	Test Condition
		Min.	Typ.	Max.		

Regulator:

Output current	I_Q	51	57	63	mA	$T_j = 100\text{ °C}$
		46	58	70	mA	$9\text{ V} \leq V_I \leq 16\text{ V}$ $T_j \leq 125\text{ °C}$
Dropout voltage $V_{dr} = V_I - V_Q$	V_{dr}	–	0.5	0.7	V	$I_Q = 40\text{ mA}$



Table 5 Electrical Characteristics (cont'd)

$V_I = 13.5\text{ V}$; $V_Q = 6\text{ V}$; $-40\text{ }^\circ\text{C} \leq T_j \leq 150\text{ }^\circ\text{C}$; unless otherwise specified

Parameter	Symbol	Limit Values			Unit	Test Condition
		Min.	Typ.	Max.		
Reverse output current	I_Q	-5	–	–	mA	$V_I = -16\text{ V}$ $V_Q = 0\text{ V}$
		-5	–	–	mA	$V_I = 0\text{ V}$ $V_Q = 16\text{ V}$
Current consumption $I_q = I_I - I_Q$	I_q	–	7	10	mA	$V_{dr} = 1\text{ V}$
Current consumption open load <i>Version TLE 4240-3 M</i>	I_q	–	30	40	mA	$I_Q = 0\text{ mA}$

Open Load Detection (Version TLE 4240-3 M only):

Lower status switching threshold $V_{IQ,L} = V_I - V_Q$	$V_{IQ,L}$	–	–	0.8	V	Ramping down ($V_I - V_Q$)
---	------------	---	---	-----	---	---------------------------------

Status Output ST (Version TLE 4240-3 M only):

Status low voltage	$V_{ST,low}$	–	–	0.4	V	$I_{ST} = 1\text{ mA}$ $I_Q = 5\text{ mA}$
Status sink current limitation	$I_{ST,MAX}$	1.5	–	–	mA	$V_{ST} = 1\text{ V}$
Status leakage current	$I_{ST,high}$	–	–	2	μA	$V_{ST} = 5\text{ V}$ ($V_I - V_Q$) > 1 V

Typical Performance Characteristics

Current Consumption I_q vs. Drop Voltage $V_{dr} = (V_i - V_Q)$

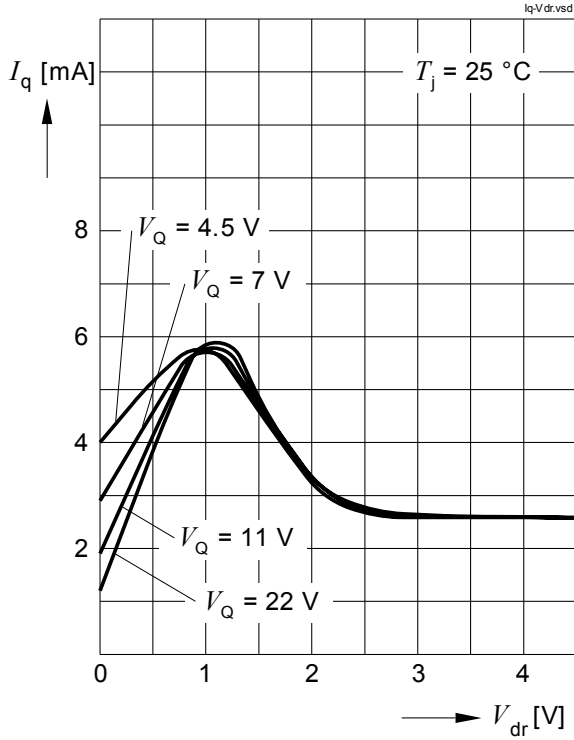

Current Consumption I_q vs. Output Current I_Q

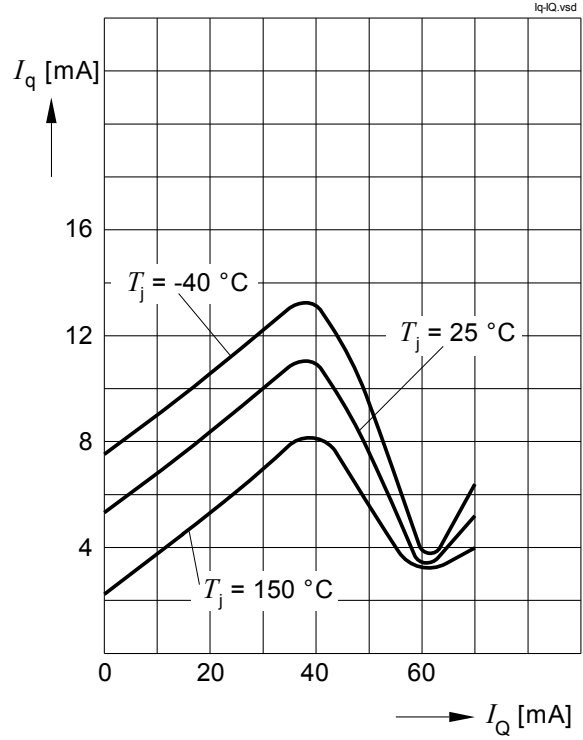

Output Current I_Q vs. Input Voltage $V_i; V_Q = 6\text{ V}$

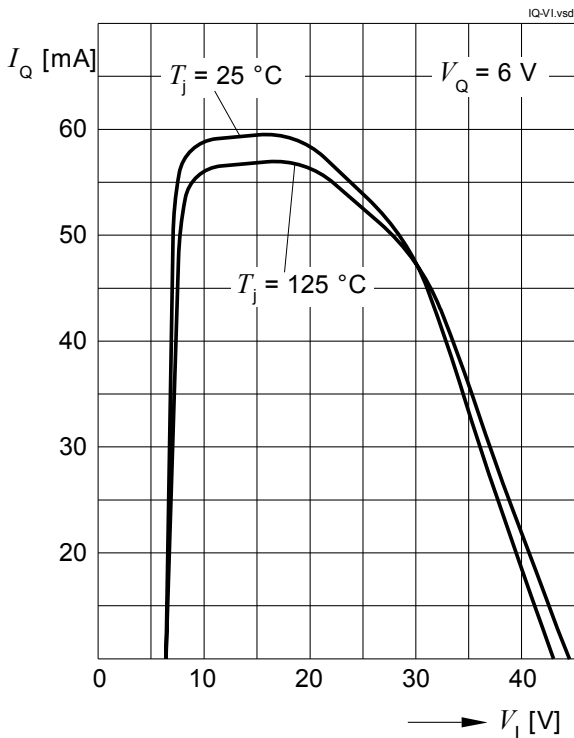

Dropout Voltage V_{dr} vs. Junction Temperature T_j

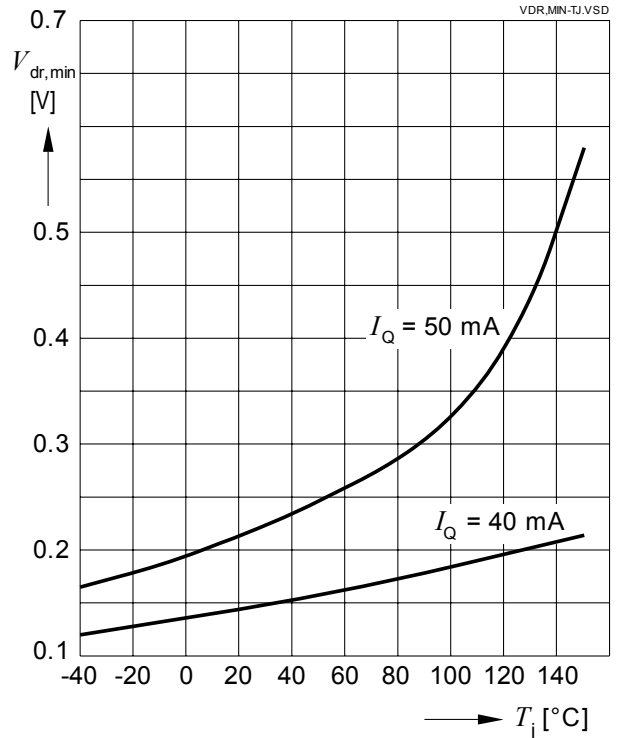



Typical Performance Characteristics

Output Current I_Q vs. Junction Temperature T_j

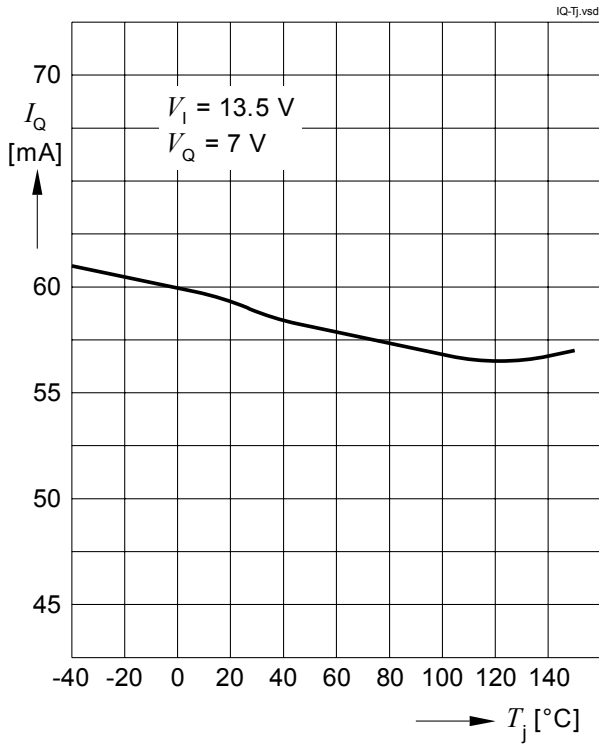

Output Current I_Q vs. Drop Voltage V_{dr} (SOA)

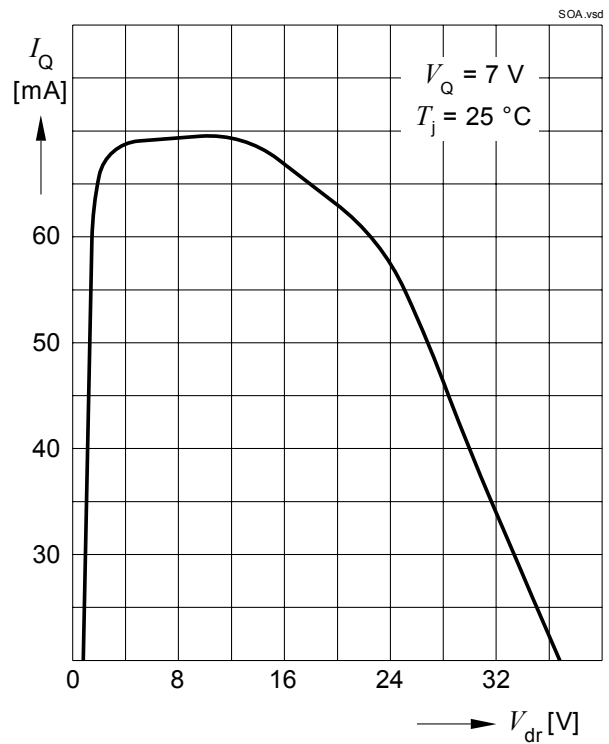

Reverse Current I_Q versus Reverse Input Voltage V_I

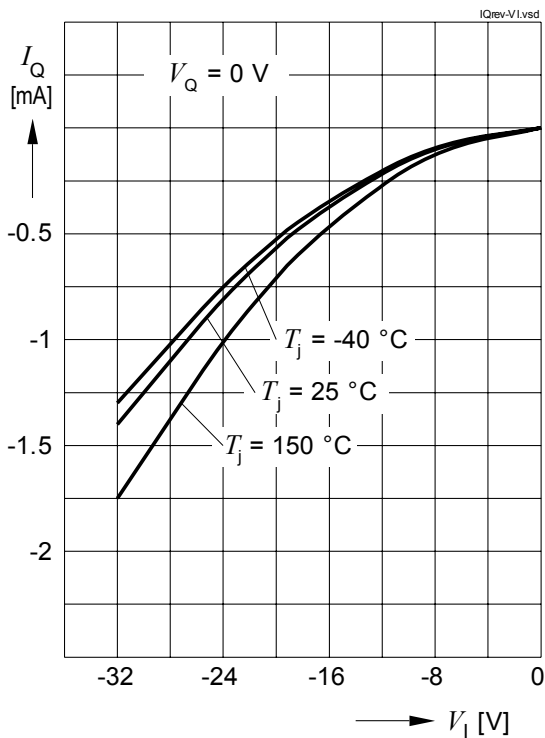

Reverse Current I_I versus Reverse Input Voltage V_I

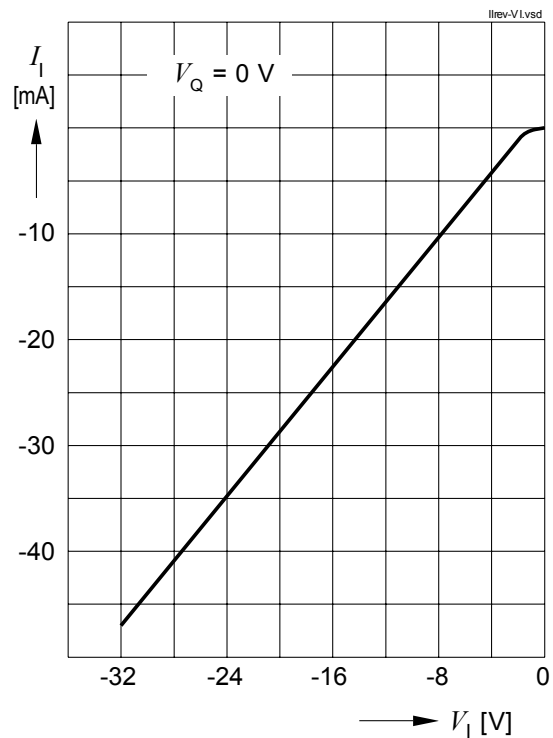



Typical Performance Characteristics

Reverse Output Current I_Q versus Output Voltage V_Q

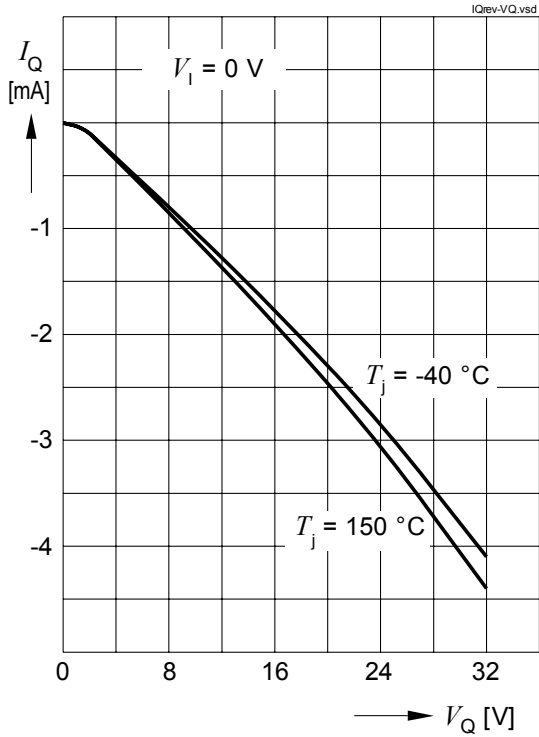

Current Consumption I_q in open load condition vs. T_j

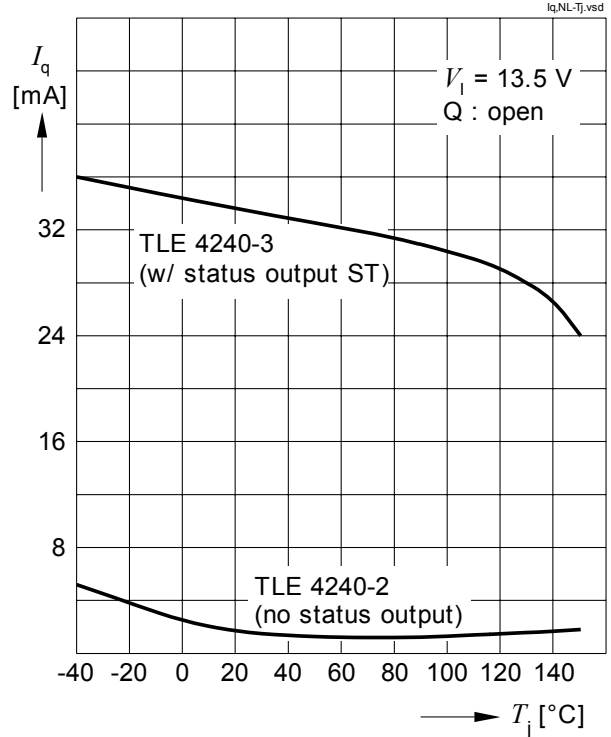

Package Outline

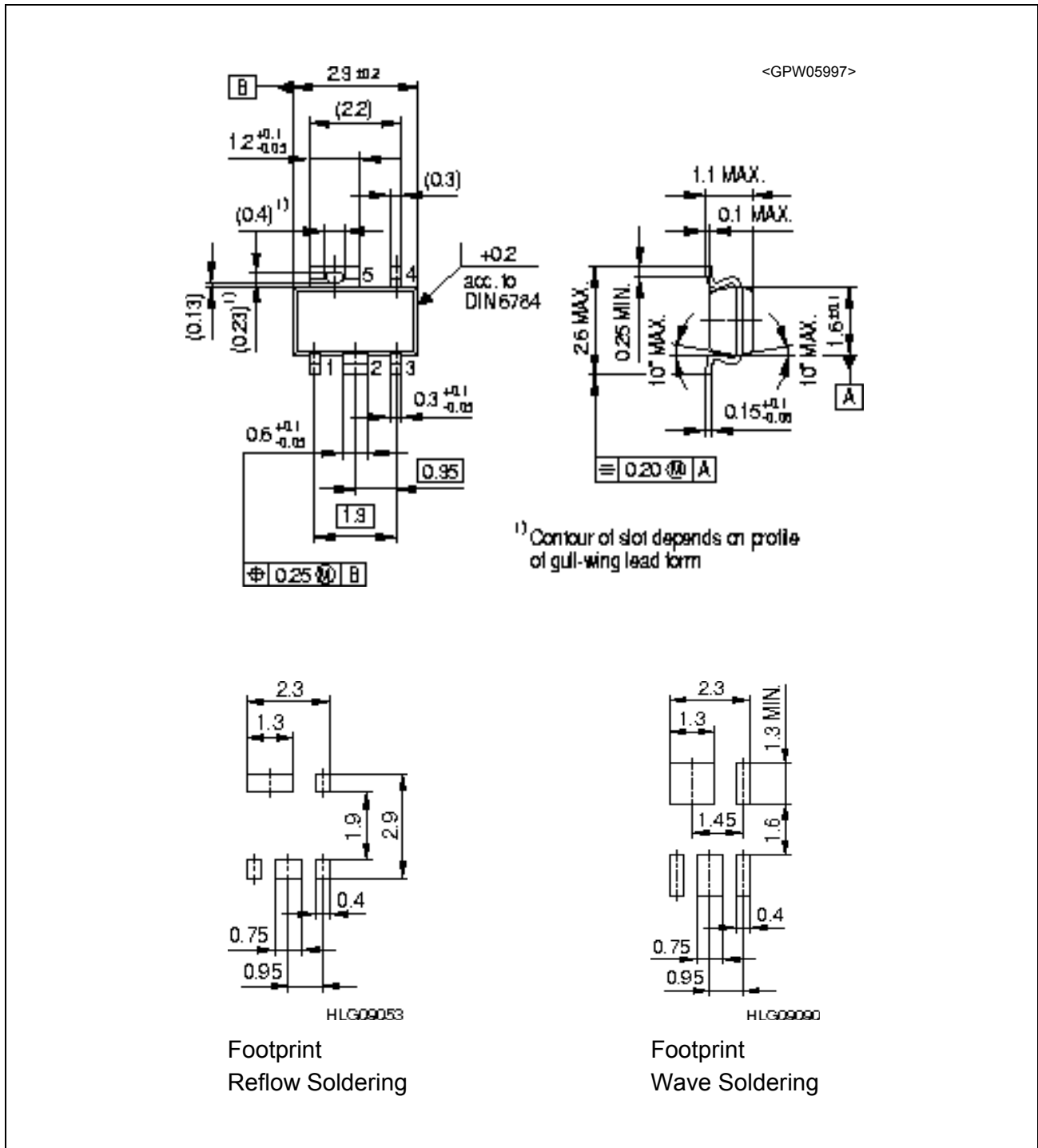

Figure 4 PG-SCT595-5

Find all packages, sorts of packing and others at Infineon Internet Page "Packages":
<http://www.infineon.com/packages>.

Edition 2006-12-07

**Published by Infineon Technologies AG,
81726 München, Germany**

**© Infineon Technologies AG 2006.
All Rights Reserved.**

Attention please!

The information given in this data sheet shall in no event be regarded as a guarantee of conditions or characteristics ("Beschaffenhheitsgarantie"). With respect to any examples or hints given herein, any typical values stated herein and/or any information regarding the application of the device, Infineon Technologies hereby disclaims any and all warranties and liabilities of any kind, including without limitation warranties of non-infringement of intellectual property rights of any third party.

Information

For further information on technology, delivery terms and conditions and prices please contact your nearest Infineon Technologies Office (www.infineon.com).

Warnings

Due to technical requirements components may contain dangerous substances. For information on the types in question please contact your nearest Infineon Technologies Office.

Infineon Technologies Components may only be used in life-support devices or systems with the express written approval of Infineon Technologies, if a failure of such components can reasonably be expected to cause the failure of that life-support device or system, or to affect the safety or effectiveness of that device or system. Life support devices or systems are intended to be implanted in the human body, or to support and/or maintain and sustain and/or protect human life. If they fail, it is reasonable to assume that the health of the user or other persons may be endangered.