



Distributor of Molex Connector Corporation: Excellent Integrated System Limited
Datasheet of 09-62-3063 - Connector Receptacle 6 Position 0.156" (3.96mm) Gold Through Hole

Contact us: sales@integrated-circuit.com Website: www.integrated-circuit.com

Excellent Integrated System Limited

Stocking Distributor

Click to view price, real time Inventory, Delivery & Lifecycle Information:

[Molex Connector Corporation](#)
[09-62-3063](#)

For any questions, you can email us directly:
sales@integrated-circuit.com

Contact us: sales@integrated-circuit.com Website: www.integrated-circuit.com

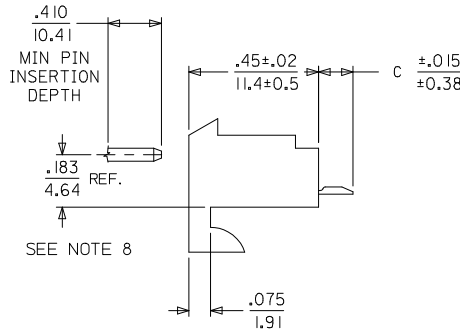
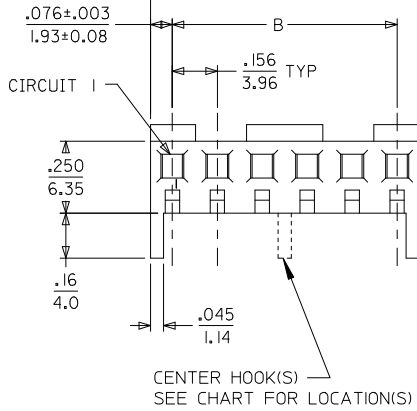

NOTES:

- HOUSING MATERIAL: NYLON, UL 94V-2
- FINISH:
 - (909) = OVERALL HOT TIN DIP: .000100/0.00254 MIN.
 - (197) = OVERALL REFLOWED MATTE TIN: 0.00152/0.00060 MIN. OVER 0.00127/0.00050 MIN. NICKEL OVERALL.
 - (208) = SELECT GOLD: .000015/0.00038 MIN. SELECT TIN: .000100/0.00254 MIN. OVERALL NICKEL UNDERPLATE: .000050/0.00127 MIN.
- PRODUCT SPECIFICATION: PS-08-50
- PACKAGING INFO: SEE CHARTS
- SOLDERABILITY SPECIFICATION: SMES-152
- RIGHT ANGLE OPTIONS SEE DRAWING SDA-2145-001
- BOTTOM ENTRY OPTIONS SEE DRAWING SDA-2145-003
- .183/4.64 DIMENSION IS BOTTOM OF HOUSING TO CENTER OF MATING PIN AND DOES NOT REFLECT CENTER OF CONNECTOR HOUSING WINDOW DIMENSION.
- THIS PART CONFORMS TO CLASS B REQUIREMENTS OF COSMETIC SPECIFICATION PS-45499-002.

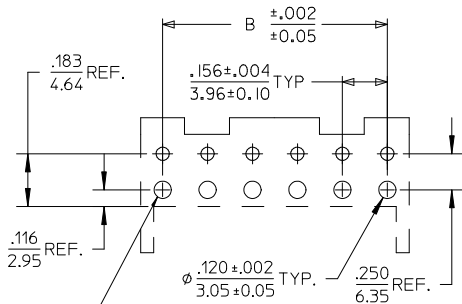

CKT.	A	B	CENTER HOOK(S) LOCATED BETWEEN CIRCUITS
02	.308 7.82	.156±.005 3.96±0.13	NONE
03	.464 11.79	.312±.005 7.92±0.13	NONE
04	.620 15.75	.468±.005 11.89±0.13	NONE
05	.776 19.71	.624±.005 15.85±0.13	NONE
06	.932 23.67	.780±.005 19.81±0.13	NONE
07	1.088 27.64	.936±.010 23.77±0.25	NONE
08	1.244 31.60	1.092±.010 27.74±0.25	4 & 5
09	1.400 35.56	1.248±.010 31.70±0.25	4 & 5
10	1.556 39.52	1.404±.010 35.66±0.25	5 & 6
11	1.712 43.48	1.560±.010 39.62±0.25	5 & 6
12	1.868 47.45	1.716±.010 43.59±0.25	4 & 5, 8 & 9
13	2.024 51.41	1.872±.010 47.55±0.25	6 & 7, 11 & 12
14	2.180 55.37	2.028±.014 51.51±0.36	5 & 6, 9 & 10
15	2.336 59.33	2.184±.014 55.47±0.36	5 & 6, 10 & 11

2-4	Z
1	Z1
SHT.	REV.

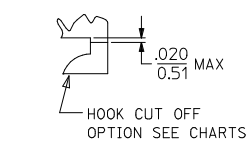

ADD HOOK LOCATION EC NO: UCP2015-3939 DRAWN: KIPPER 2015/03/25 CHKD: ANNGUYEN 2015/03/25 APPR: FSMITH 2015/03/27	QUALITY SYMBOLS ∇=0 ∇=0 ∇=0	GENERAL TOLERANCES (UNLESS SPECIFIED) 4 PLACES ± --- ± --- 3 PLACES ± --- ± .010 2 PLACES ± 0.25 ± .014 1 PLACE ± 0.36 ± --- 0 PLACE ± ± ANGULAR ± 1/2° DRAFT WHERE APPLICABLE MUST REMAIN WITHIN DIMENSIONS	DIMENSION STYLE IN/MM DRAWN BY DATE SAMIEC 2003/01/16 CHECKED BY DATE SAMIEC 2003/01/16 APPROVED BY DATE MARGULIS 2003/01/16	SCALE --- DESIGN UNITS INCH THIRD ANGLE PROJECTION	TITLE KK 156 HOUSING ASSY PC TAIL TOP ENTRY molex	MATERIAL NO. SEE CHART	DOCUMENT NO. SDA-2145-002	SHEET NO. 1 OF 4



Contact us: sales@integrated-circuit.com Website: www.integrated-circuit.com

KK 156 PCB ASSY 2-15 CKT

2145 TOP ENTRY SERIES

OPTIONS	RAMPS:	YES	RAMPS:	YES
	HOOKS:	YES	HOOKS:	YES
	COLOR:	WHITE	COLOR:	WHITE
	MOLD VOID:	NONE	MOLD VOID:	NONE
	TERM MATL:	PHOS BRONZE	TERM MATL:	PHOS BRONZE
	CONTACT:	STANDARD	CONTACT:	STANDARD
	PC TAIL (C):	.120 / 3.05	PC TAIL (C):	.120 / 3.05
	PLT CODE:	197 - TIN	PLT CODE:	208 - 15 GOLD
	TERM VOID:	NONE	TERM VOID:	NONE
	PACKAGING:	TRAY PK-2145-001	PACKAGING:	TRAY PK-2145-001
Ckt	Material No		Material No	
2	09-62-6025		09-62-4029	
3	09-62-6035		09-62-4039	
4	09-62-6045		09-62-4049	
5	09-62-6055		09-62-4059	
6	09-62-6065		09-62-4069	
7	09-62-6075		09-62-4079	
8	09-62-6085		09-62-4089	
9	09-62-6095		09-62-4099	
10	09-62-6105		09-62-4109	
11	09-62-6115		09-62-4119	
12	09-62-6125		09-62-4129	
13	09-62-6135		09-62-4139	
14	09-62-6145		09-62-4149	
15	09-62-6155		09-62-4159	

REV: Z	CHANGE PLATING UCP2012-1821 01/04/2012	TITLE: KK 156 PCB ASSY 2145 TOP ENTRY SERIES	SHEET No. - 2 -
DOCUMENT NUMBER: SDA-2145-002		CREATED / REVISED BY: MMSTROH	CHECKED BY: MKIPPER
		APPROVED BY: FSMITH	



Contact us: sales@integrated-circuit.com Website: www.integrated-circuit.com

KK 156 PCB ASSY 2-15 CKT

2145 TOP ENTRY SERIES

OPTIONS	RAMPS:	YES	RAMPS:	YES	RAMPS:	YES	RAMPS:	YES
	HOOKS:	YES	HOOKS:	YES	HOOKS:	CUT OFF	HOOKS:	YES
	COLOR:	WHITE	COLOR:	WHITE	COLOR:	WHITE	COLOR:	WHITE
	MOLD VOID:	NONE	MOLD VOID:	NONE	MOLD VOID:	NONE	MOLD VOID:	NONE
	TERM MATL:	BRASS	TERM MATL:	BRASS	TERM MATL:	BRASS	TERM MATL:	BRASS
	CONTACT:	STANDARD	CONTACT:	STANDARD	CONTACT:	STANDARD	CONTACT:	STANDARD
	PC TAIL (C):	.120 / 3.05	PC TAIL (C):	.189 / 4.80	PC TAIL (C):	.120 / 3.05	PC TAIL (C):	.120 / 3.05
	PLT CODE:	197 - TIN	PLT CODE:	P909 - TIN	PLT CODE:	P909 - TIN	PLT CODE:	P909 - TIN
	TERM VOID:	NONE	TERM VOID:	NONE	TERM VOID:	NONE	TERM VOID:	NONE
PACKAGING:	TRAY PK-2145-001	PACKAGING:	TRAY PK-2145-001	PACKAGING:	TRAY PK-2145-001	PACKAGING:	TRAY PK-2145-001	
Ckt	Material No		Material No		Material No		Material No	
2	09-52-1023		09-52-1029		09-52-3023		09-52-3023	
3	09-52-1033		09-52-1039		09-52-3034		09-52-3033	
4	09-52-1043		09-52-1049		09-52-3044		09-52-3043	
5	09-52-1053		09-52-1059		09-52-3054		09-52-3053	
6	09-52-1063		09-52-1069		09-52-3064		09-52-3063	
7	09-52-1073		09-52-1079				09-52-3073	
8	09-52-1083		09-52-1089		09-52-3089		09-52-3083	
9	09-52-1093		09-52-1099		09-52-3094		09-52-3093	
10	09-52-1103		09-52-1109				09-52-3103	
11	09-52-1113		09-52-1119				09-52-3113	
12	09-52-1123		09-52-1129				09-52-3123	
13	09-52-1133		09-52-1139				09-52-3133	
14	09-52-1143		09-52-1149				09-52-3143	
15	09-52-1153		09-52-1159				09-52-3153	

REV: Z	CHANGE PLATING UCP2012-1821 01/04/2012	TITLE: KK 156 PCB ASSY 2145 TOP ENTRY SERIES	SHEET No. - 3 -
DOCUMENT NUMBER: SDA-2145-002		CREATED / REVISED BY: MMSTROH	CHECKED BY: MKIPPER
		APPROVED BY: FSMITH	



Contact us: sales@integrated-circuit.com Website: www.integrated-circuit.com

KK 156 PCB ASSY 2-15 CKT

2145 TOP ENTRY SERIES

OPTIONS	RAMPS:	NO	RAMPS:	YES	RAMPS:	YES		
	HOOKS:	CUT OFF	HOOKS:	YES	HOOKS:	YES		
	COLOR:	WHITE	COLOR:	WHITE	COLOR:	WHITE		
	MOLD VOID:	NONE	MOLD VOID:	NONE	MOLD VOID:	NONE		
	TERM MATL:	BRASS	TERM MATL:	BRASS	TERM MATL:	PHOS BRONZE		
	CONTACT:	STANDARD	CONTACT:	STANDARD	CONTACT:	STANDARD		
	PC TAIL (C):	.120 / 3.05	PC TAIL (C):	.120 / 3.05	PC TAIL (C):	.120 / 3.05		
	PLT CODE:	P909 - TIN	PLT CODE:	208 - 15 GOLD	PLT CODE:	P909 - TIN		
	TERM VOID:	NONE	TERM VOID:	NONE	TERM VOID:	NONE		
PACKAGING:	TRAY PK-2145-001	PACKAGING:	TRAY PK-2145-001	PACKAGING:	TRAY PK-2145-001			
Ckt	Material No	Material No	Material No					
2	09-52-1025	09-62-3023	09-52-2029					
3	09-52-1035	09-62-3033	09-52-2039					
4	09-52-1045	09-62-3043	09-52-2049					
5	09-52-1055	09-62-3053	09-52-2059					
6	09-52-1065	09-62-3063	09-52-2069					
7	09-52-1075	09-62-3073	09-52-2079					
8	09-52-1085	09-62-3083	09-52-2089					
9	09-52-1095	09-62-3093	09-52-2099					
10	09-52-1105	09-62-3103	09-52-2109					
11	09-52-1115	09-62-3113	09-52-2119					
12	09-52-1125	09-62-3123	09-52-2129					
13	09-52-1135	09-62-3133	09-52-2139					
14	09-52-1145	09-62-3143	09-52-2149					
15	09-52-1155	09-62-3153	09-52-2159					

REV: Z	CHANGE PLATING UCP2012-1821 01/04/2012	TITLE: KK 156 PCB ASSY 2145 TOP ENTRY SERIES	SHEET No. - 4 -
DOCUMENT NUMBER: SDA-2145-002		CREATED / REVISED BY: MMSTROH	CHECKED BY: MKIPPER
		APPROVED BY: FSMITH	