

Excellent Integrated System Limited

Stocking Distributor

Click to view price, real time Inventory, Delivery & Lifecycle Information:

[IXYS Corporation](#)

[IXBH12N300](#)

For any questions, you can email us directly:

sales@integrated-circuit.com

IXYS

High Voltage, High Gain BIMOSFET™ Monolithic Bipolar MOS Transistor

IXBT12N300 IXBH12N300

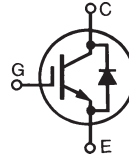

$$V_{CES} = 3000V$$

$$I_{C110} = 12A$$

$$V_{CE(sat)} \leq 3.2V$$

Symbol	Test Conditions	Maximum Ratings	
V_{CES}	$T_C = 25^\circ C$ to $150^\circ C$	3000	V
V_{CGR}	$T_J = 25^\circ C$ to $150^\circ C$, $R_{GE} = 1M\Omega$	3000	V
V_{GES}	Continuous	± 20	V
V_{GEM}	Transient	± 30	V
I_{C25}	$T_C = 25^\circ C$	30	A
I_{C110}	$T_C = 110^\circ C$	12	A
I_{CM}	$T_C = 25^\circ C$, 1ms	100	A
SSOA (RBSOA)	$V_{GE} = 15V$, $T_{VJ} = 125^\circ C$, $R_G = 30\Omega$ Clamped Inductive Load	$I_{CM} = 98$ 1500	A V
P_C	$T_C = 25^\circ C$	160	W
T_J		-55 ... +150	$^\circ C$
T_{JM}		150	$^\circ C$
T_{stg}		-55 ... +150	$^\circ C$
T_L	1.6mm (0.062 in.) from Case for 10s	300	$^\circ C$
T_{SOLD}	Plastic Body for 10 seconds	260	$^\circ C$
M_d	Mounting Torque (TO-247)	1.13/10	Nm/lb.in.
Weight	TO-268	4	g
	TO-247	6	g

TO-268 (IXBT)

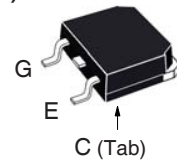

TO-247 (IXBH)

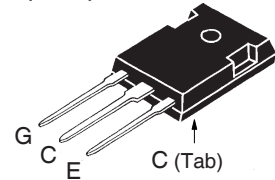

G = Gate C = Collector
E = Emitter Tab = Collector

Features

- High Blocking Voltage
- International Standard Packages
- Anti-Parallel Diode
- Low Conduction Losses

Advantages

- Low Gate Drive Requirement
- High Power Density

Applications:

- Switched-Mode and Resonant-Mode Power Supplies
- Uninterruptible Power Supplies (UPS)
- Laser Generators
- Capacitor Discharge Circuits
- AC Switches

Symbol	Test Conditions ($T_J = 25^\circ C$ Unless Otherwise Specified)	Characteristic Values		
		Min.	Typ.	Max.
BV_{CES}	$I_C = 250\mu A$, $V_{GE} = 0V$	3000		V
$V_{GE(th)}$	$I_C = 250\mu A$, $V_{CE} = V_{GE}$	3.0		5.0 V
I_{CES}	$V_{CE} = 0.8 \cdot V_{CES}$, $V_{GE} = 0V$ $T_J = 125^\circ C$			25 μA 1 mA
I_{GES}	$V_{CE} = 0V$, $V_{GE} = \pm 20V$			± 100 nA
$V_{CE(sat)}$	$I_C = 12A$, $V_{GE} = 15V$, Note 1 $T_J = 125^\circ C$		2.8	3.2 V
			3.5	V

IXYS

IXBT12N300 IXBH12N300

Symbol Test Conditions

($T_J = 25^\circ\text{C}$ Unless Otherwise Specified)

Characteristic Values

		Min.	Typ.	Max.	
g_{fs}	$I_C = 12\text{A}, V_{CE} = 10\text{V}$, Note 1	6.5	10.8		S
C_{ies}	$V_{CE} = 25\text{V}, V_{GE} = 0\text{V}, f = 1\text{MHz}$		1290		pF
C_{oes}			56		pF
C_{res}			19		pF
Q_g	$I_C = 12\text{A}, V_{GE} = 15\text{V}, V_{CE} = 1000\text{V}$		62		nC
Q_{ge}			13		nC
Q_{gc}			8.5		nC
$t_{d(on)}$	Resistive Switching Times, $T_J = 25^\circ\text{C}$ $I_C = 12\text{A}, V_{GE} = 15\text{V}$ $V_{CE} = 1250\text{V}, R_G = 10\Omega$		64		ns
t_r			140		ns
$t_{d(off)}$			180		ns
t_f			540		ns
$t_{d(on)}$	Resistive Switching Times, $T_J = 125^\circ\text{C}$ $I_C = 12\text{A}, V_{GE} = 15\text{V}$ $V_{CE} = 1250\text{V}, R_G = 10\Omega$		65		ns
t_r			395		ns
$t_{d(off)}$			175		ns
t_f			530		ns
R_{thJC}				0.78	$^\circ\text{C/W}$
R_{thCS}	TO-247	0.21			$^\circ\text{C/W}$

Reverse Diode

Symbol Test Conditions

($T_J = 25^\circ\text{C}$ Unless Otherwise Specified)

Characteristic Values

		Min.	Typ.	Max.	
V_F	$I_F = 12\text{A}, V_{GE} = 0\text{V}$			2.1	V
t_{rr}	$I_F = 6\text{A}, V_{GE} = 0\text{V}, -di_F/dt = 100\text{A}/\mu\text{s}$ $V_R = 100\text{V}, V_{GE} = 0\text{V}$		1.4		μs
I_{RM}			21		A

Note 1: Pulse test, $t \leq 300\mu\text{s}$, duty cycle, $d \leq 2\%$.

TO-268 Outline

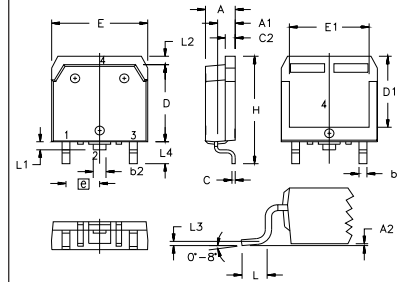

Terminals: 1 - Gate
3 - Emitter
2,4 - Collector

SYM	INCHES		MILLIMETERS	
	MIN	MAX	MIN	MAX
A	.193	.201	4.90	5.10
A1	.106	.114	2.70	2.90
A2	.001	.010	0.02	0.25
b	.045	.057	1.15	1.45
b2	.075	.083	1.90	2.10
C	.016	.026	0.40	0.65
C2	.057	.063	1.45	1.60
D	.543	.551	13.80	14.00
D1	.488	.500	12.40	12.70
E	.624	.632	15.85	16.05
E1	.524	.535	13.30	13.60
e	.215 BSC		5.45 BSC	
H	.736	.752	18.70	19.10
L	.094	.106	2.40	2.70
L1	.047	.055	1.20	1.40
L2	.039	.045	1.00	1.15
L3	.010 BSC		0.25 BSC	
L4	.150	.161	3.80	4.10

TO-247 Outline

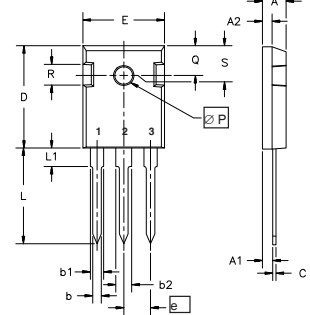

Terminals: 1 - Gate
3 - Emitter
2 - Collector

Dim.	Millimeter		Inches	
	Min.	Max.	Min.	Max.
A	4.7	5.3	.185	.209
A ₁	2.2	2.54	.087	.102
A ₂	2.2	2.6	.059	.098
b	1.0	1.4	.040	.055
b ₁	1.65	2.13	.065	.084
b ₂	2.87	3.12	.113	.123
C	.4	.8	.016	.031
D	20.80	21.46	.819	.845
E	15.75	16.26	.610	.640
e	5.20	5.72	0.205	0.225
L	19.81	20.32	.780	.800
L1		4.50		.177
∅P	3.55	3.65	.140	.144
Q	5.89	6.40	0.232	0.252
R	4.32	5.49	.170	.216
S	6.15	BSC	242	BSC

IXYS Reserves the Right to Change Limits, Test Conditions and Dimensions.

IXYS MOSFETs and IGBTs are covered by one or more of the following U.S. patents:

4,835,592	4,931,844	5,049,961	5,237,481	6,162,665	6,404,065 B1	6,683,344	6,727,585	7,005,734 B2	7,157,338B2
4,860,072	5,017,508	5,063,307	5,381,025	6,259,123 B1	6,534,343	6,710,405 B2	6,759,692	7,063,975 B2	
4,881,106	5,034,796	5,187,117	5,486,715	6,306,728 B1	6,583,505	6,710,463	6,771,478 B2	7,071,537	

Fig. 1. Output Characteristics @ $T_J = 25^\circ\text{C}$

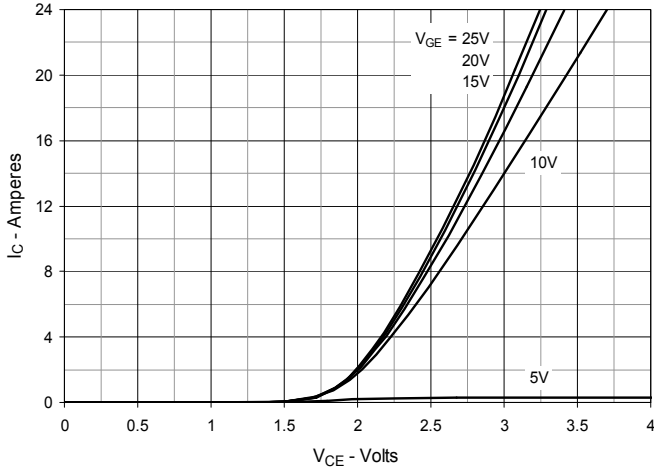

Fig. 2. Extended Output Characteristics @ $T_J = 25^\circ\text{C}$

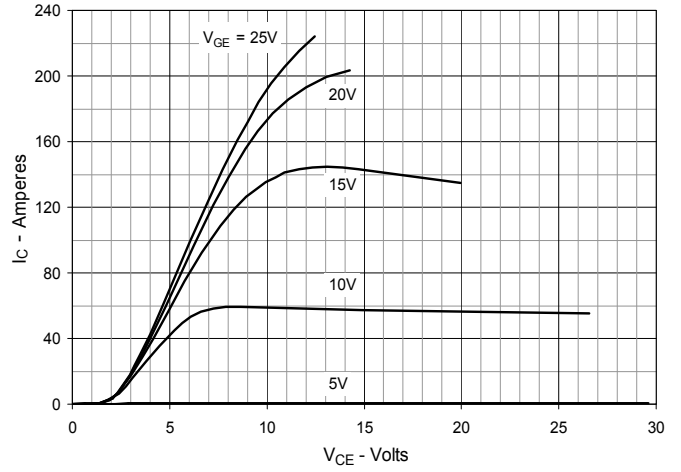

Fig. 3. Output Characteristics @ $T_J = 125^\circ\text{C}$

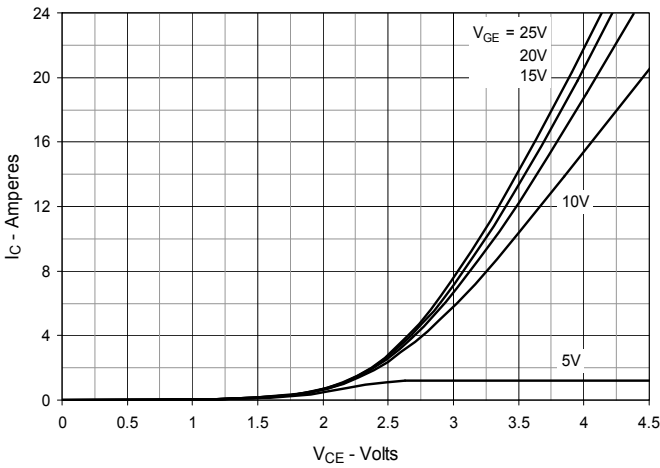

Fig. 4. Dependence of $V_{CE(sat)}$ on Junction Temperature

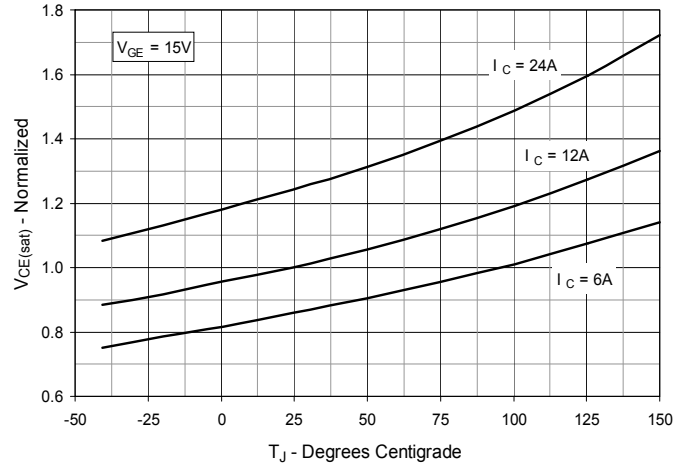

Fig. 5. Collector-to-Emitter Voltage vs. Gate-to-Emitter Voltage

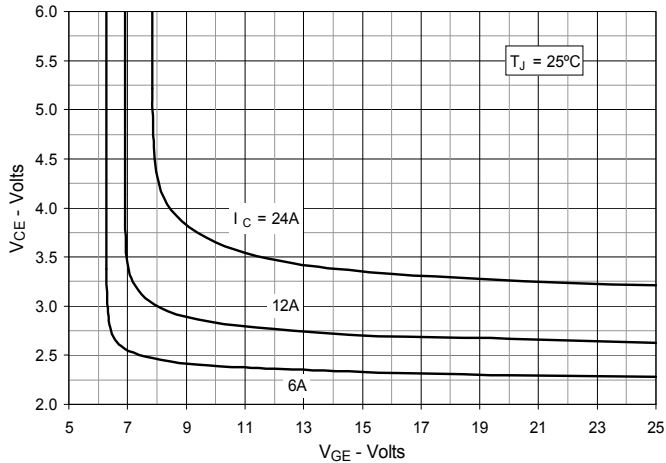

Fig. 6. Input Admittance

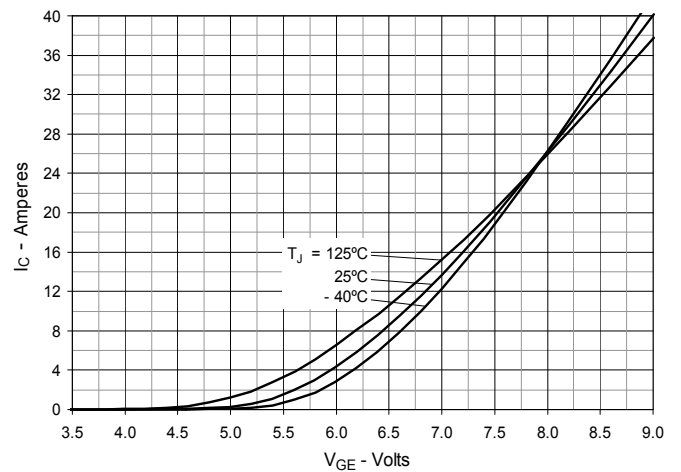

Fig. 7. Transconductance

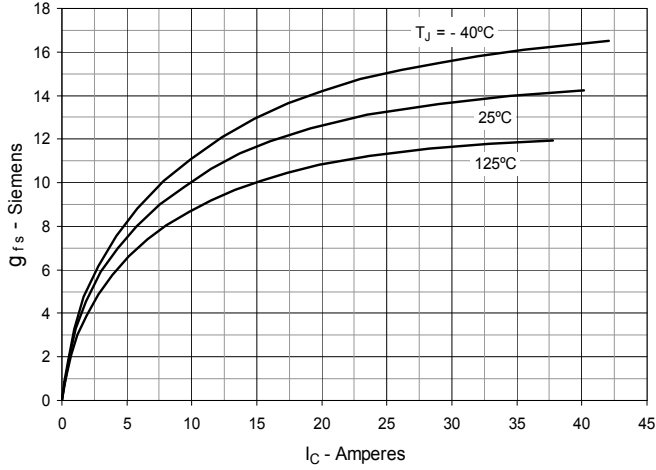

Fig. 8. Forward Voltage Drop of Intrinsic Diode

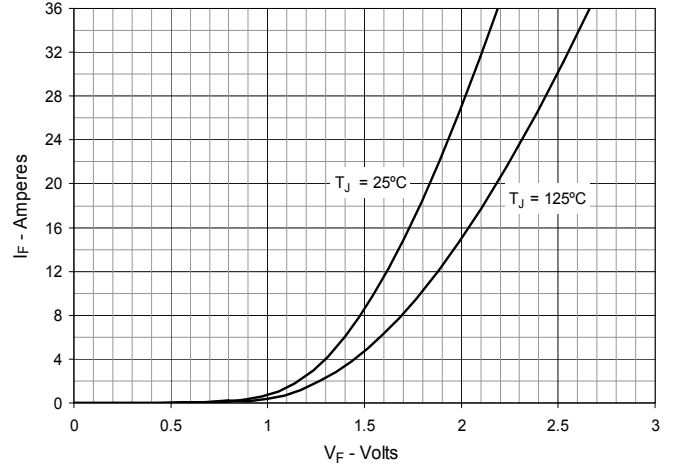

Fig. 9. Gate Charge

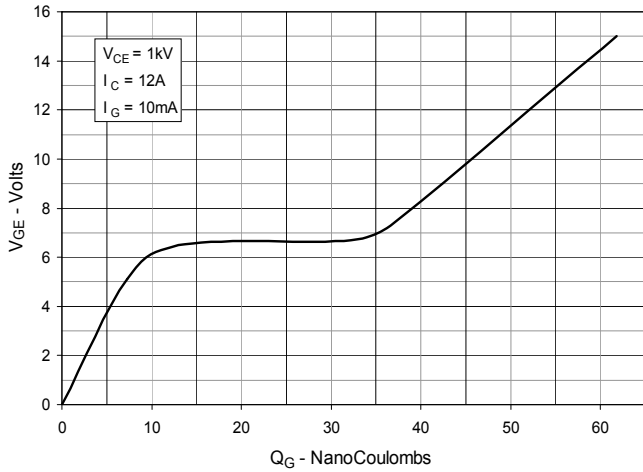

Fig. 10. Capacitance

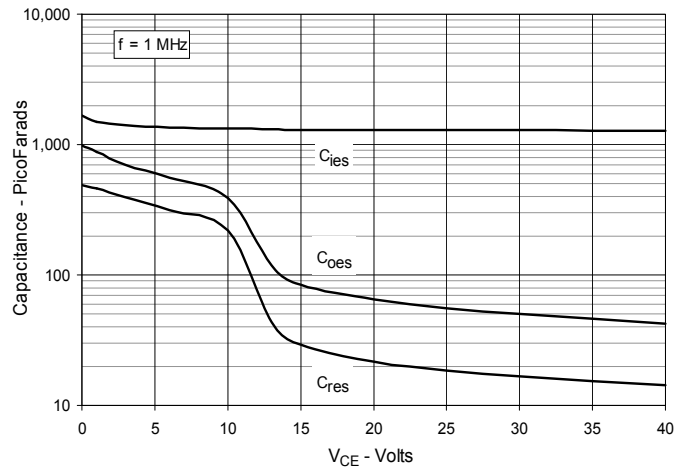

Fig. 11. Reverse-Bias Safe Operating Area

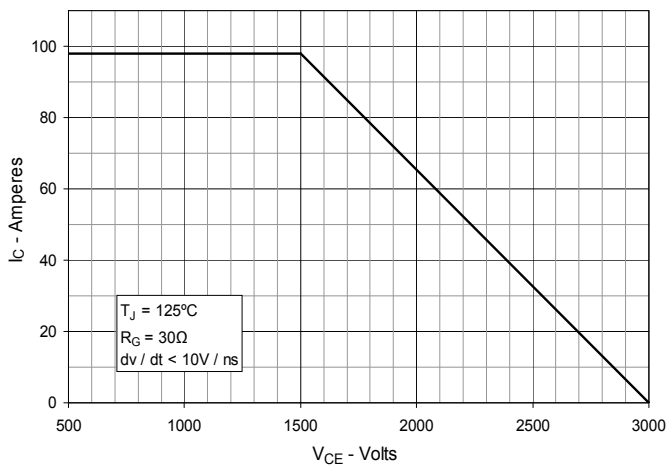

Fig. 12. Maximum Transient Thermal Impedance

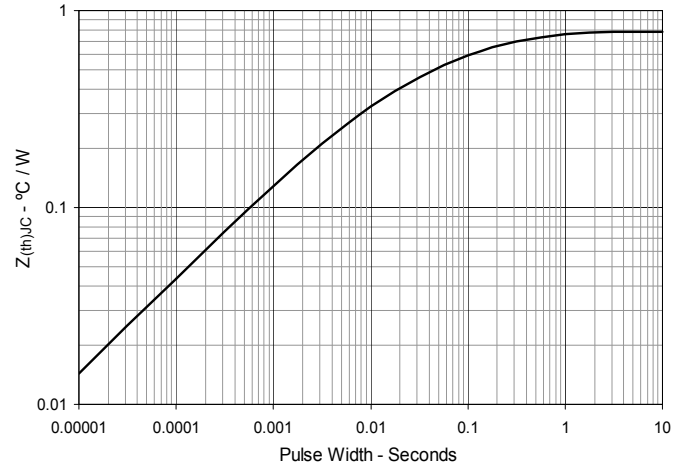

Fig. 13. Resistive Turn-on Rise Time vs. Junction Temperature

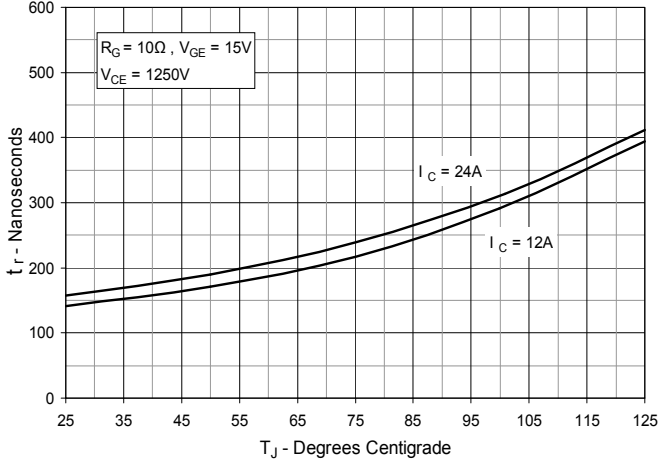

Fig. 14. Resistive Turn-on Rise Time vs. Collector Current

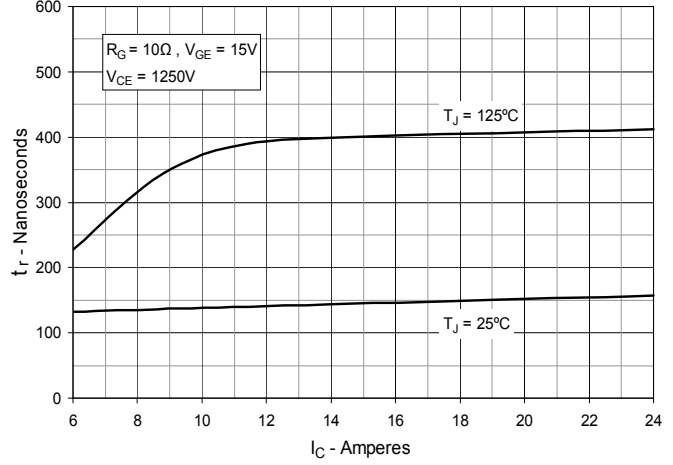

Fig. 15. Resistive Turn-on Switching Times vs. Gate Resistance

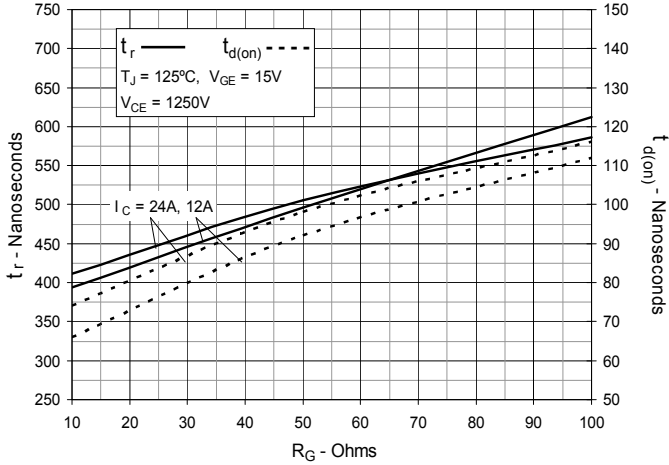

Fig. 16. Resistive Turn-off Switching Times vs. Junction Temperature

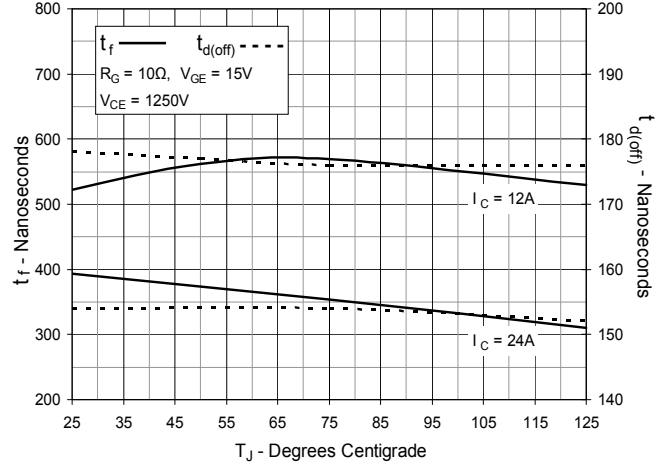

Fig. 17. Resistive Turn-off Switching Times vs. Collector Current

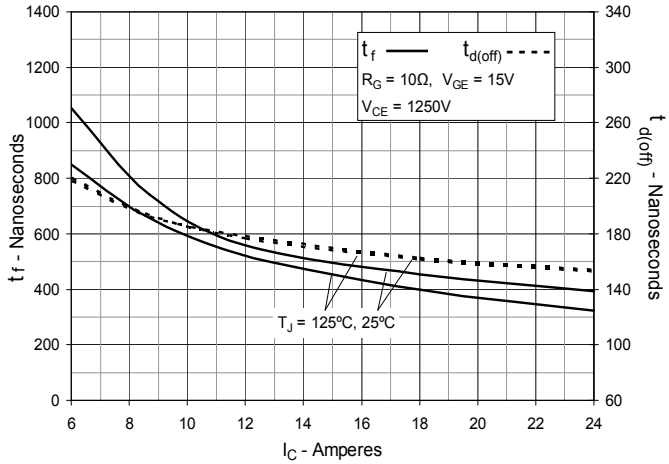

Fig. 18. Resistive Turn-off Switching Times vs. Gate Resistance

