

Date	SYM	REVISION RECORD	AUTH	DR.	CK.
11/14/14	E	UPDATED TO ROHS 2 COMPLIANT	T.B.	B.S.	
12/11/15	F	CHANGED MICRO SEC. TO MILLISECONDS	T.B.	B.S.	

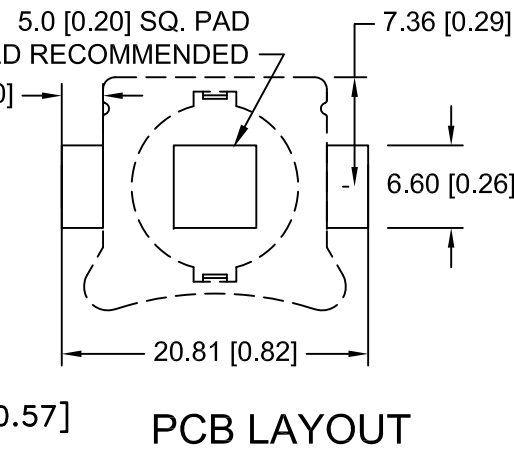

# INSULATOR

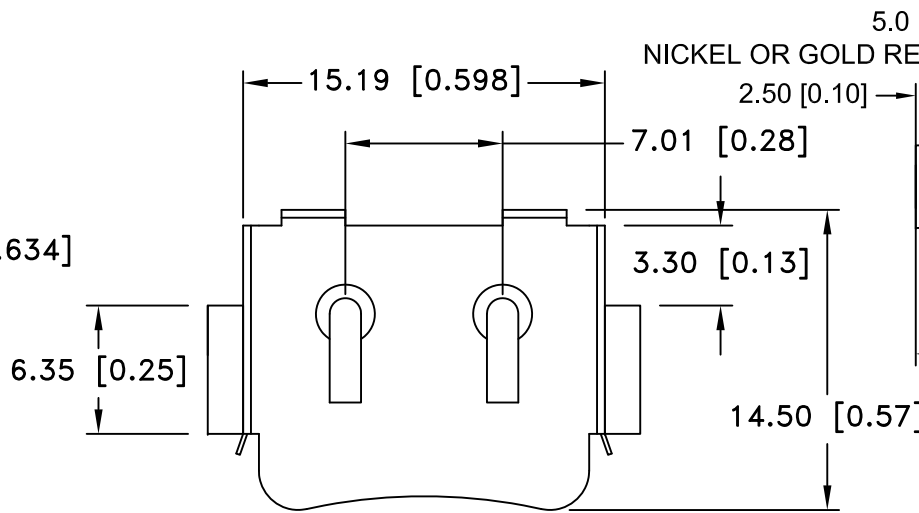
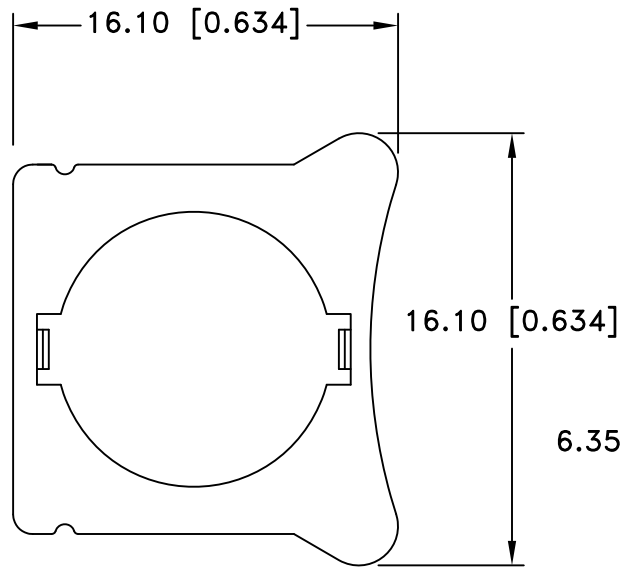
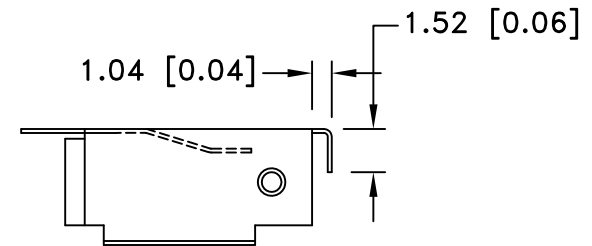
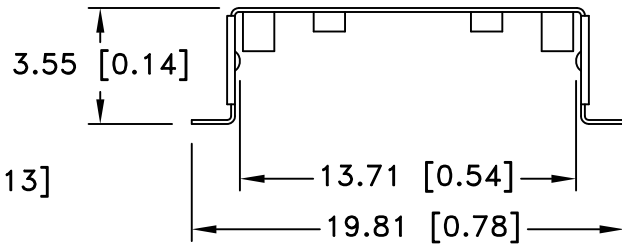
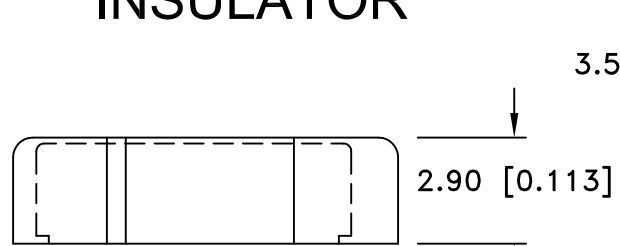

## SPECIFICATIONS:

- \* Holder material- Polypropylene, AV161 PP, Off White
- \* UL Flammability Rating: UL 94-HB File No. E108370
- \* Contacts : Phosphor Bronze C5191, Nickel Plated 80-150u thickness
- \* Vibration test: 10-50-10 hz swept in 60 seconds  
x,y,z direction: 1 hour each direction
- \* Result: no dislodgement of the cell or damage  
no discontinuity over 10 milliseconds
- \* Shock test: half sine wave acceleration 150g.  
6 milliseconds 3 shock pulses each direction per axis,  
total of 18 pulses
- \* Result: no evidence of physical damage
- \* ROHS 2 COMPLIANT

Tolerance (Except as noted)	 <b>Memory Protection Devices, Inc</b> 200 Broad Hollow Road, Farmingdale, New York 11735	Scale	Drawn By B.S.
		Approved By T.B.	
decimal ±.5 (.020)	Title CR1225 BATTERY RETAINER WITH INSULATOR		
Fractional ± .8 (.030)	Date 12/11/15	Drawing Number BHX1-1225-SM	
Angular ± 3°			