

Excellent Integrated System Limited

Stocking Distributor

Click to view price, real time Inventory, Delivery & Lifecycle Information:

[Weidmüller](#)
[1000380001](#)

For any questions, you can email us directly:
sales@integrated-circuit.com

Product catalogue | PCB connection systems | PCB plug-in connectors | Pitch 5.00 / 5.08 mm (0.197 / 0.200 inch) | Female PUSH IN socket block with spring connection in 5.00/5.08 pitch | BLF 5.00-5.08/90/270 | BLF 5.08/90F SN

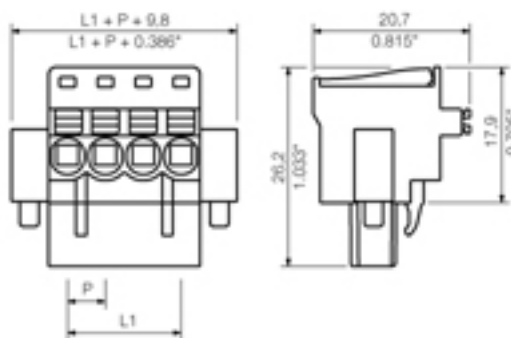
General ordering data

Order No.	1000380001
Part designation	BLF 5.08/18/90F SN BK BX
Version	PCB plug-in connector, PUSH IN, Clamping range, max.: 3.31 mm ² , Pitch in mm: 5.08 mm, No. of poles: 18, 90°, Box
EAN	4032248690343
Qty.	18 pc(s).
Packaging	Box

System parameters

Conductor connection system	PUSH IN
Outgoing direction of conductor	90°
Pitch in mm	5.08 mm
Pitch in inch	0.2 inch
No. of poles	18
No. of rows	1
Screwdriver blade	0.6 x 3.5
Screwdriver blade standard	DIN 5264
Stripping length	10 mm
L1 in mm	86.36 mm
L1 in inch	3.4 inch
Electric shock protection to DIN VDE 0470	IP 20
Electric shock protection to DIN VDE 57 106	Safe from finger touch

Material data

Insulating material	PBT
Colour	black
colour chart	Similar to RAL 9011
Flammability class UL 94	V-0
Contact material	CuSn
Contact surface	tinned
Contact base material	CuSn

Product catalogue | PCB connection systems | PCB plug-in connectors | Pitch 5.00 / 5.08 mm (0.197 / 0.200 inch) | Female PUSH IN socket block with spring connection in 5.00/5.08 pitch | BLF 5.00-5.08/90/270 | BLF 5.08/90F SN

Connectable conductors

Clamping range, min.	0.13 mm ²
Clamping range, max.	3.31 mm ²
Conductor connection cross-section AWG, min.	AWG 26
Conductor connection cross-section AWG, max.	AWG 12
Solid, min. H05(07) V-U	0.2 mm ²
Solid, max. H05(07) V-U	2.5 mm ²
Stranded, max. H07V-R	2 mm ²
Stranded, min. H07V-R	0 mm ²
Flexible, min. H05(07) V-K	0.2 mm ²
Flexible, max. H05(07) V-K	2.5 mm ²
w. wire end ferrule, DIN 46228 pt 1, min	0.2 mm ²
with wire end ferrule, DIN 46228 pt 1, max.	2.5 mm ²
w. plastic collar ferrule, DIN 46228 pt 4, min.	0.2 mm ²
with plastic collar ferrule, DIN 46228 pt 4, max.	2.5 mm ²
Gauge to EN 60999 a x b; ø	2.4 mm x 1.5 mm

DIN IEC rating data

Rated current, min. No. of poles (Tu=20°C)	18.5 A
Rated current, max. No. of poles (Tu=20°C)	6 A
Rated current, no. of poles (Tu=40°C), min.	12.5 A
Rated current, no. of poles (Tu=40°C), max.	6 A
Rated voltage for overvoltage class/pollution severity II/2	400 V
Rated voltage for overvoltage class/pollution severity III/2	320 V
Rated voltage at overvoltage category/pollution degree III/3	250 V
Rated impulse withstand voltage for overvoltage class/pollution severity II/2	4 kV
Rated impulse withstand voltage for overvoltage class/pollution severity III/2	4 kV
Rated impulse withstand voltage for overvoltage class/pollution severity III/3	4 kV
Short-time withstand current resistance	3 x 1s with 120 A

Approvals

Approvals institutes	CSA; CURUS; ROHS
----------------------	------------------

Classifications

eClass 6.0	27-26-07-08
------------	-------------

Notes

Notes

Similar products

Order No.	Part designation	Version
1000220001	BLF 5.08/02/90F SN BK BX	PCB plug-in connector, PUSH IN, Clamping range, max.: 3.31 mm ² , Pitch in mm: 5.08 mm, No. of poles: 2, 90°, Box

Product catalogue | PCB connection systems | PCB plug-in connectors | Pitch 5.00 / 5.08 mm (0.197 / 0.200 inch) | Female PUSH IN socket block with spring connection in 5.00/5.08 pitch | BLF 5.00-5.08/90/270 | BLF 5.08/90F SN

1000230001	BLF 5.08/03/90F SN BK BX	PCB plug-in connector, PUSH IN, Clamping range, max.: 3.31 mm ² , Pitch in mm: 5.08 mm, No. of poles: 3, 90°, Box
1000240001	BLF 5.08/04/90F SN BK BX	PCB plug-in connector, PUSH IN, Clamping range, max.: 3.31 mm ² , Pitch in mm: 5.08 mm, No. of poles: 4, 90°, Box
1000250001	BLF 5.08/05/90F SN BK BX	PCB plug-in connector, PUSH IN, Clamping range, max.: 3.31 mm ² , Pitch in mm: 5.08 mm, No. of poles: 5, 90°, Box
1000260001	BLF 5.08/06/90F SN BK BX	PCB plug-in connector, PUSH IN, Clamping range, max.: 3.31 mm ² , Pitch in mm: 5.08 mm, No. of poles: 6, 90°, Box
1000270001	BLF 5.08/07/90F SN BK BX	PCB plug-in connector, PUSH IN, Clamping range, max.: 3.31 mm ² , Pitch in mm: 5.08 mm, No. of poles: 7, 90°, Box
1000280001	BLF 5.08/08/90F SN BK BX	PCB plug-in connector, PUSH IN, Clamping range, max.: 3.31 mm ² , Pitch in mm: 5.08 mm, No. of poles: 8, 90°, Box
1000290001	BLF 5.08/09/90F SN BK BX	PCB plug-in connector, PUSH IN, Clamping range, max.: 3.31 mm ² , Pitch in mm: 5.08 mm, No. of poles: 9, 90°, Box
1000300001	BLF 5.08/10/90F SN BK BX	PCB plug-in connector, PUSH IN, Clamping range, max.: 3.31 mm ² , Pitch in mm: 5.08 mm, No. of poles: 10, 90°, Box
1000310001	BLF 5.08/11/90F SN BK BX	PCB plug-in connector, PUSH IN, Clamping range, max.: 3.31 mm ² , Pitch in mm: 5.08 mm, No. of poles: 11, 90°, Box
1000320001	BLF 5.08/12/90F SN BK BX	PCB plug-in connector, PUSH IN, Clamping range, max.: 3.31 mm ² , Pitch in mm: 5.08 mm, No. of poles: 12, 90°, Box
1000330001	BLF 5.08/13/90F SN BK BX	PCB plug-in connector, PUSH IN, Clamping range, max.: 3.31 mm ² , Pitch in mm: 5.08 mm, No. of poles: 13, 90°, Box
1000340001	BLF 5.08/14/90F SN BK BX	PCB plug-in connector, PUSH IN, Clamping range, max.: 3.31 mm ² , Pitch in mm: 5.08 mm, No. of poles: 14, 90°, Box
1000350001	BLF 5.08/15/90F SN BK BX	PCB plug-in connector, PUSH IN, Clamping range, max.: 3.31 mm ² , Pitch in mm: 5.08 mm, No. of poles: 15, 90°, Box
1000360001	BLF 5.08/16/90F SN BK BX	PCB plug-in connector, PUSH IN, Clamping range, max.: 3.31 mm ² , Pitch in mm: 5.08 mm, No. of poles: 16, 90°, Box
1000370001	BLF 5.08/17/90F SN BK BX	PCB plug-in connector, PUSH IN, Clamping range, max.: 3.31 mm ² , Pitch in mm: 5.08 mm, No. of poles: 17, 90°, Box
1000390001	BLF 5.08/19/90F SN BK BX	PCB plug-in connector, PUSH IN, Clamping range, max.: 3.31 mm ² , Pitch in mm: 5.08 mm, No. of poles: 19, 90°, Box
1000400001	BLF 5.08/20/90F SN BK BX	PCB plug-in connector, PUSH IN, Clamping range, max.: 3.31 mm ² , Pitch in mm: 5.08 mm, No. of poles: 20, 90°, Box