

Excellent Integrated System Limited

Stocking Distributor

Click to view price, real time Inventory, Delivery & Lifecycle Information:

[Weidmüller](#)
[1983020000](#)

For any questions, you can email us directly:
sales@integrated-circuit.com

Product catalogue | PCB connection systems | PCB plug-in connectors | Pitch 5.00 / 5.08 mm (0.197 / 0.200 inch) | Female PUSH IN socket block with spring connection in 5.00/5.08 pitch | BLF 5.00-5.08/90/270 | BLF 5.08/270F SN

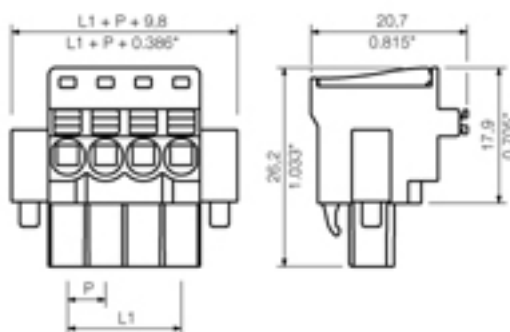
General ordering data

Order No.	1983020000
Part designation	BLF 5.08/15/270F SN OR BX
Version	PCB plug-in connector, PUSH IN, Clamping range, max.: 3.31 mm ² , Pitch in mm: 5.08 mm, No. of poles: 15, 270°, Box
EAN	4032248687114
Qty.	18 pc(s).
Packaging	Box

System parameters

Conductor connection system	PUSH IN
Outgoing direction of conductor	270°
Pitch in mm	5.08 mm
Pitch in inch	0.2 inch
No. of poles	15
No. of rows	1
Screwdriver blade	0.6 x 3.5
Screwdriver blade standard	DIN 5264
Stripping length	10 mm
L1 in mm	71.12 mm
L1 in inch	2.8 inch
Electric shock protection to DIN VDE 0470	IP 20
Electric shock protection to DIN VDE 57 106	Safe from finger touch

Material data

Insulating material	PBT
Colour	Orange
colour chart	Similar to RAL 2000
Flammability class UL 94	V-0
Contact material	CuSn
Contact surface	tinned
Contact base material	CuSn

Product catalogue | PCB connection systems | PCB plug-in connectors | Pitch 5.00 / 5.08 mm (0.197 / 0.200 inch) | Female PUSH IN socket block with spring connection in 5.00/5.08 pitch | BLF 5.00-5.08/90/270 | BLF 5.08/270F SN

Connectable conductors

Clamping range, min.	0.13 mm ²
Clamping range, max.	3.31 mm ²
Conductor connection cross-section AWG, min.	AWG 26
Conductor connection cross-section AWG, max.	AWG 12
Solid, min. H05(07) V-U	0.2 mm ²
Solid, max. H05(07) V-U	2.5 mm ²
Stranded, max. H07V-R	2 mm ²
Stranded, min. H07V-R	0 mm ²
Flexible, min. H05(07) V-K	0.2 mm ²
Flexible, max. H05(07) V-K	2.5 mm ²
w. wire end ferrule, DIN 46228 pt 1, min	0.2 mm ²
with wire end ferrule, DIN 46228 pt 1, max.	2.5 mm ²
w. plastic collar ferrule, DIN 46228 pt 4, min.	0.2 mm ²
with plastic collar ferrule, DIN 46228 pt 4, max.	2.5 mm ²
Gauge to EN 60999 a x b; ø	2.4 mm x 1.5 mm

DIN IEC rating data

Rated current, min. No. of poles (Tu=20°C)	18.5 A
Rated current, max. No. of poles (Tu=20°C)	6 A
Rated current, no. of poles (Tu=40°C), min.	12.5 A
Rated current, no. of poles (Tu=40°C), max.	6 A
Rated voltage for overvoltage class/pollution severity II/2	400 V
Rated voltage for overvoltage class/pollution severity III/2	320 V
Rated voltage at overvoltage category/pollution degree III/3	250 V
Rated impulse withstand voltage for overvoltage class/pollution severity II/2	4 kV
Rated impulse withstand voltage for overvoltage class/pollution severity III/2	4 kV
Rated impulse withstand voltage for overvoltage class/pollution severity III/3	4 kV
Short-time withstand current resistance	3 x 1s with 120 A

Approvals

Approvals institutes	CSA; CURUS
----------------------	------------

Classifications

eClass 6.0	27-26-07-08
------------	-------------

Notes

Notes

Similar products

Order No.	Part designation	Version
1982120000	BLF 5.08/02/270F SN BK BX	PCB plug-in connector, PUSH IN, Clamping range, max.: 3.31 mm ² , Pitch in mm: 5.08 mm, No. of poles: 2, 270°, Box

Product catalogue | PCB connection systems | PCB plug-in connectors | Pitch 5.00 / 5.08 mm (0.197 / 0.200 inch) | Female PUSH IN socket block with spring connection in 5.00/5.08 pitch | BLF 5.00-5.08/90/270 | BLF 5.08/270F SN

1982130000	BLF 5.08/03/270F SN BK BX	PCB plug-in connector, PUSH IN, Clamping range, max.: 3.31 mm ² , Pitch in mm: 5.08 mm, No. of poles: 3, 270°, Box
1982140000	BLF 5.08/04/270F SN BK BX	PCB plug-in connector, PUSH IN, Clamping range, max.: 3.31 mm ² , Pitch in mm: 5.08 mm, No. of poles: 4, 270°, Box
1982150000	BLF 5.08/05/270F SN BK BX	PCB plug-in connector, PUSH IN, Clamping range, max.: 3.31 mm ² , Pitch in mm: 5.08 mm, No. of poles: 5, 270°, Box
1982160000	BLF 5.08/06/270F SN BK BX	PCB plug-in connector, PUSH IN, Clamping range, max.: 3.31 mm ² , Pitch in mm: 5.08 mm, No. of poles: 6, 270°, Box
1982170000	BLF 5.08/07/270F SN BK BX	PCB plug-in connector, PUSH IN, Clamping range, max.: 3.31 mm ² , Pitch in mm: 5.08 mm, No. of poles: 7, 270°, Box
1982180000	BLF 5.08/08/270F SN BK BX	PCB plug-in connector, PUSH IN, Clamping range, max.: 3.31 mm ² , Pitch in mm: 5.08 mm, No. of poles: 8, 270°, Box
1982190000	BLF 5.08/09/270F SN BK BX	PCB plug-in connector, PUSH IN, Clamping range, max.: 3.31 mm ² , Pitch in mm: 5.08 mm, No. of poles: 9, 270°, Box
1982200000	BLF 5.08/10/270F SN BK BX	PCB plug-in connector, PUSH IN, Clamping range, max.: 3.31 mm ² , Pitch in mm: 5.08 mm, No. of poles: 10, 270°, Box
1982210000	BLF 5.08/11/270F SN BK BX	PCB plug-in connector, PUSH IN, Clamping range, max.: 3.31 mm ² , Pitch in mm: 5.08 mm, No. of poles: 11, 270°, Box
1982220000	BLF 5.08/12/270F SN BK BX	PCB plug-in connector, PUSH IN, Clamping range, max.: 3.31 mm ² , Pitch in mm: 5.08 mm, No. of poles: 12, 270°, Box
1982230000	BLF 5.08/13/270F SN BK BX	PCB plug-in connector, PUSH IN, Clamping range, max.: 3.31 mm ² , Pitch in mm: 5.08 mm, No. of poles: 13, 270°, Box
1982240000	BLF 5.08/14/270F SN BK BX	PCB plug-in connector, PUSH IN, Clamping range, max.: 3.31 mm ² , Pitch in mm: 5.08 mm, No. of poles: 14, 270°, Box
1982250000	BLF 5.08/15/270F SN BK BX	PCB plug-in connector, PUSH IN, Clamping range, max.: 3.31 mm ² , Pitch in mm: 5.08 mm, No. of poles: 15, 270°, Box
1982260000	BLF 5.08/16/270F SN BK BX	PCB plug-in connector, PUSH IN, Clamping range, max.: 3.31 mm ² , Pitch in mm: 5.08 mm, No. of poles: 16, 270°, Box
1982270000	BLF 5.08/17/270F SN BK BX	PCB plug-in connector, PUSH IN, Clamping range, max.: 3.31 mm ² , Pitch in mm: 5.08 mm, No. of poles: 17, 270°, Box
1982280000	BLF 5.08/18/270F SN BK BX	PCB plug-in connector, PUSH IN, Clamping range, max.: 3.31 mm ² , Pitch in mm: 5.08 mm, No. of poles: 18, 270°, Box
1982290000	BLF 5.08/19/270F SN BK BX	PCB plug-in connector, PUSH IN, Clamping range, max.: 3.31 mm ² , Pitch in mm: 5.08 mm, No. of poles: 19, 270°, Box
1982300000	BLF 5.08/20/270F SN BK BX	PCB plug-in connector, PUSH IN, Clamping range, max.: 3.31 mm ² , Pitch in mm: 5.08 mm, No. of poles: 20, 270°, Box