

Excellent Integrated System Limited

Stocking Distributor

Click to view price, real time Inventory, Delivery & Lifecycle Information:

[Bel Fuse Inc.](#)
[0810-2H8R-28-F](#)

For any questions, you can email us directly:
sales@integrated-circuit.com



THE INFORMATION CONTAINED HEREIN IS CONSIDERED "PROPRIETARY" TO BEL FUSE INC. AND SHALL NOT BE COPIED, REPRODUCED OR DISCLOSED WITHOUT THE WRITTEN APPROVAL OF BEL FUSE INC.

LED POLARITY			
PIN 9	PIN 10	PIN 11	COLOR
-	+	/	GREEN
/	+	-	YELLOW

ELECTRICAL CHARACTERISTICS @ 25°C

TURNS RATIO OCL @ 0.1V, 100KHz 8mA DC BIAS INSERTION LOSS 100KHz TO 100MHz RETURN LOSS (MIN.) 1MHz-30MHz 60MHz-80MHz XTALK 100KHz TO 100MHz LED VF (FORWARD VOLTAGE) IF=20mA YELLOW GREEN YELLW 2.1V TYP. LD (DOMINANT WAVELENGTH) IF=20mA YELLOW GREEN YELLW 590nm TYP. HIPOT (Isolation Voltage): 1500 Vrms or 2250VDC	1CT : 1CT ±3% 350µH MIN. -1.1 dB -18 dB -12 dB -35 dB MIN. 2.2V TYP. 565nm TYP.
--	--

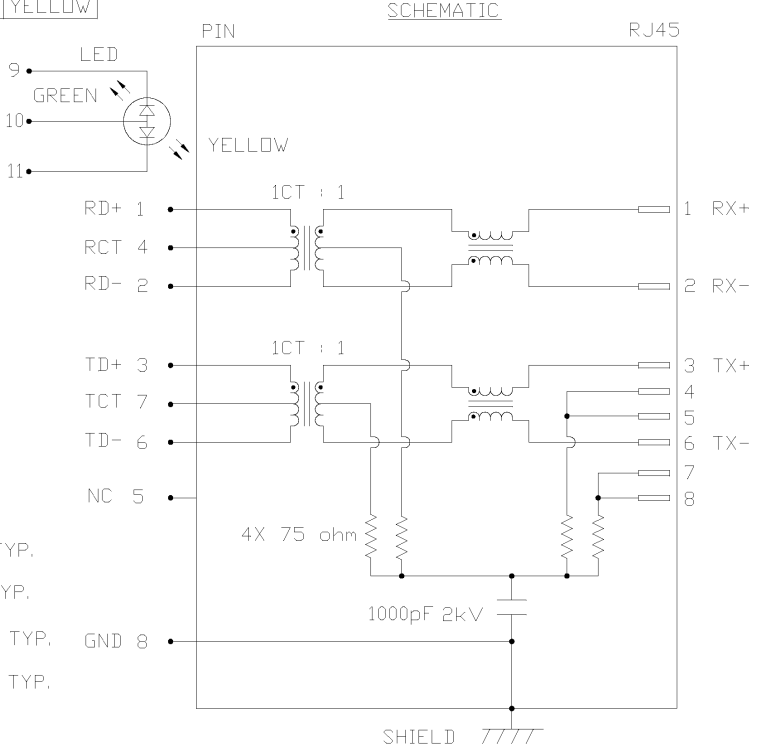

ORIGINATED BY CHUNG	DATE 01-18-07	TITLE 2X8 MagJack® with LED	PART NO. / DRAWING NO. 08102H8R28-F	STANDARD DIM. TOL. IN INCH .X .XX .XXX	[] METRIC DIM. AS REFERENCE UNIT : INCH [mm] SCALE : N/A	REV. : A SIZE : A4 PAGE : 2	COMPONENTS FOR A CONNECTED PLANET
DRAWN BY DE	DATE 01-18-07	TITLE 0810-2H8R-28-F	FILE NAME 08102H8R28-FA.DWG				

THE INFORMATION CONTAINED HEREIN IS CONSIDERED "PROPRIETARY" TO BEL FUSE INC. AND SHALL NOT BE COPIED, REPRODUCED OR DISCLOSED WITHOUT THE WRITTEN APPROVAL OF BEL FUSE INC.

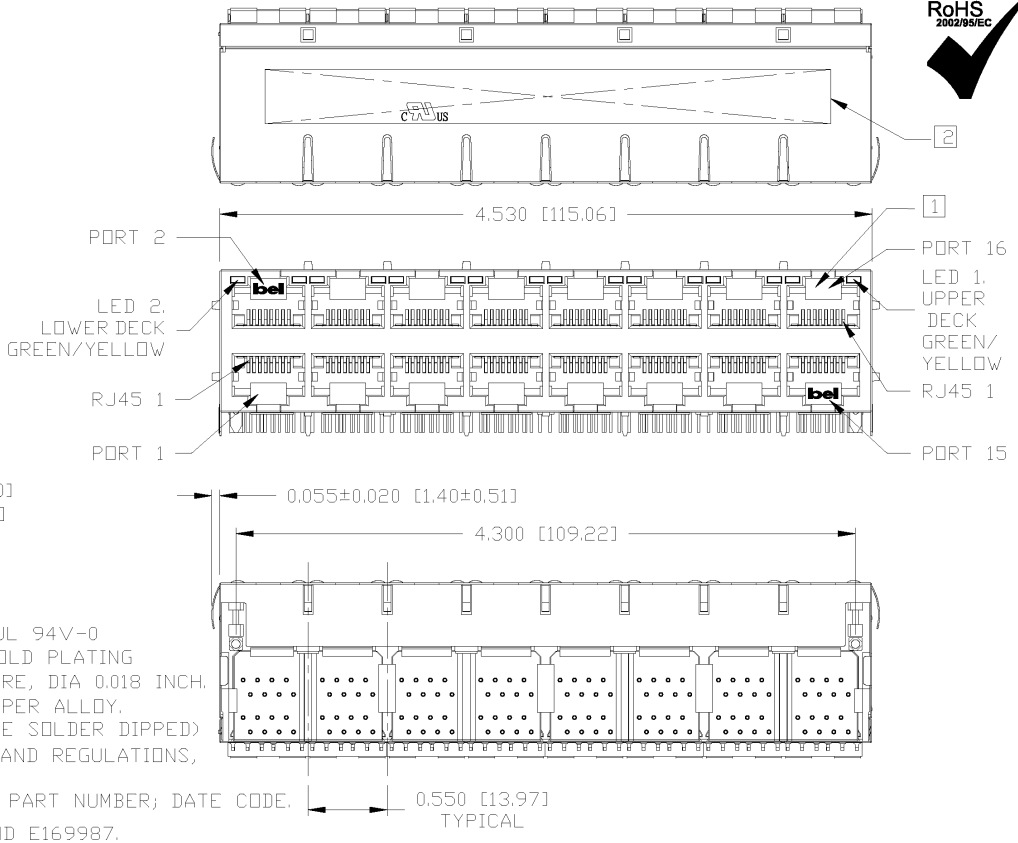
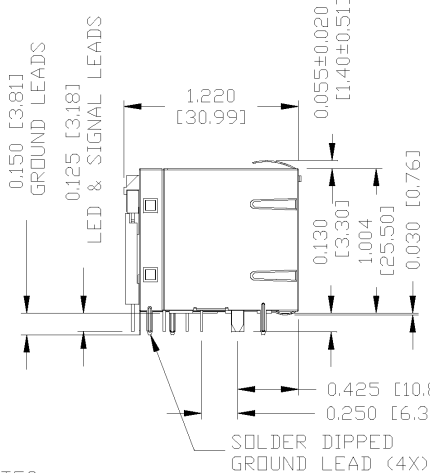

- NOTES:
 PLASTIC HOUSING: THERMOPLASTIC PBT
 FLAMMABILITY RATING UL 94V-0
 CONTACT PLATING: 30 MICRO-INCH HARD GOLD PLATING
 OUTPUT PINS: TIN-COATED COPPER WIRE, DIA 0.018 INCH.
 METAL SHIELD: NICKEL PLATED ON COPPER ALLOY.
 (ALL GROUND LEADS ARE SOLDER DIPPED)
- JACK CAVITY CONFORMS TO FCC RULES AND REGULATIONS, PART 68 SUBPART F.
 - MARK PART WITH MFG. LOGO; MFG. NAME; PART NUMBER; DATE CODE.
- UL RECOGNIZED - FILE #E196366 AND E169987.
 3. RoHS COMPLIANCE, PER EU DIRECTIVE 2002/95/EC.

ORIGINATED BY	DATE	TITLE	PART NO. / DRAWING NO.	STANDARD DIM. TOL. IN INCH	[] METRIC DIM. AS REFERENCE	 COMPONENTS FOR A CONNECTED PLANET	
QIN/BILL	01-18-07	2X8 MagJack® with LED 0810-2H8R-28-F	08102H8R28-F	.X	UNIT : INCH [mm]		REV. : A
DRAWN BY	DATE		FILE NAME	.XX	SCALE : N/A		SIZE : A4
TING	01-18-07		08102H8R28-FA.DWG	.XXX ±0.010		PAGE : 3	



THE INFORMATION CONTAINED HEREIN IS CONSIDERED 'PROPRIETARY' TO BEL FUSE INC. AND SHALL NOT BE COPIED, REPRODUCED OR DISCLOSED WITHOUT THE WRITTEN APPROVAL OF BEL FUSE INC.

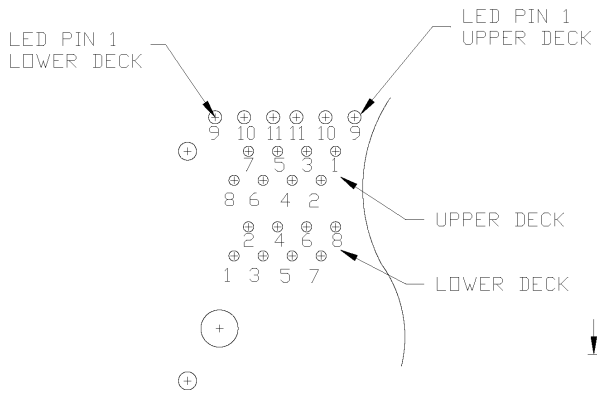

PIN-OUT INFORMATION
(COMPONENT SIDE VIEW)

11	YELLOW LED CATHODE
10	COMMON ANODE
9	GREEN LED CATHODE
8	GND
7	TCT
6	TD-
5	NC
4	RCT
3	TD+
2	RD-
1	RD+

PORT ASSIGNMENT
(COMPONENT SIDE VIEW)

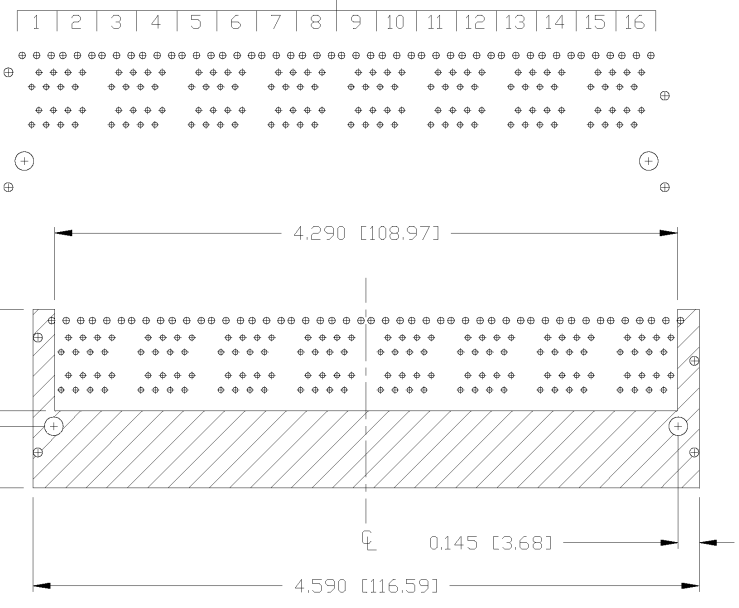

THE SHADED AREA ON THE CUSTOMER BOARD ARE RECOMMENDED TO BE CLEAR OFF ANY VIA HOLE OR COMPONENT PAD.

ORIGINATED BY QIN/BILL	DATE 01-18-07	TITLE 2X8 MagJack® with LED 0810-2H8R-28-F	PART NO. / DRAWING NO. 08102H8R28-F	STANDARD DIM. TOL. IN INCH	[] METRIC DIM. AS REFERENCE	 COMPONENTS FOR A CONNECTED PLANET					
DRAWN BY TING	DATE 01-18-07		FILE NAME 08102H8R28-FA.DWG	<table border="1"> <tr><td>.X</td><td></td></tr> <tr><td>.XX</td><td></td></tr> <tr><td>.XXX</td><td>±0.004</td></tr> </table>	.X			.XX		.XXX	±0.004
.X											
.XX											
.XXX	±0.004										
					SCALE : N/A	SIZE : A4					
					PAGE : 4						



THE INFORMATION CONTAINED HEREIN IS CONSIDERED "PROPRIETARY" TO BEL FUSE INC. AND SHALL NOT BE COPIED, REPRODUCED OR DISCLOSED WITHOUT THE WRITTEN APPROVAL OF BEL FUSE INC.

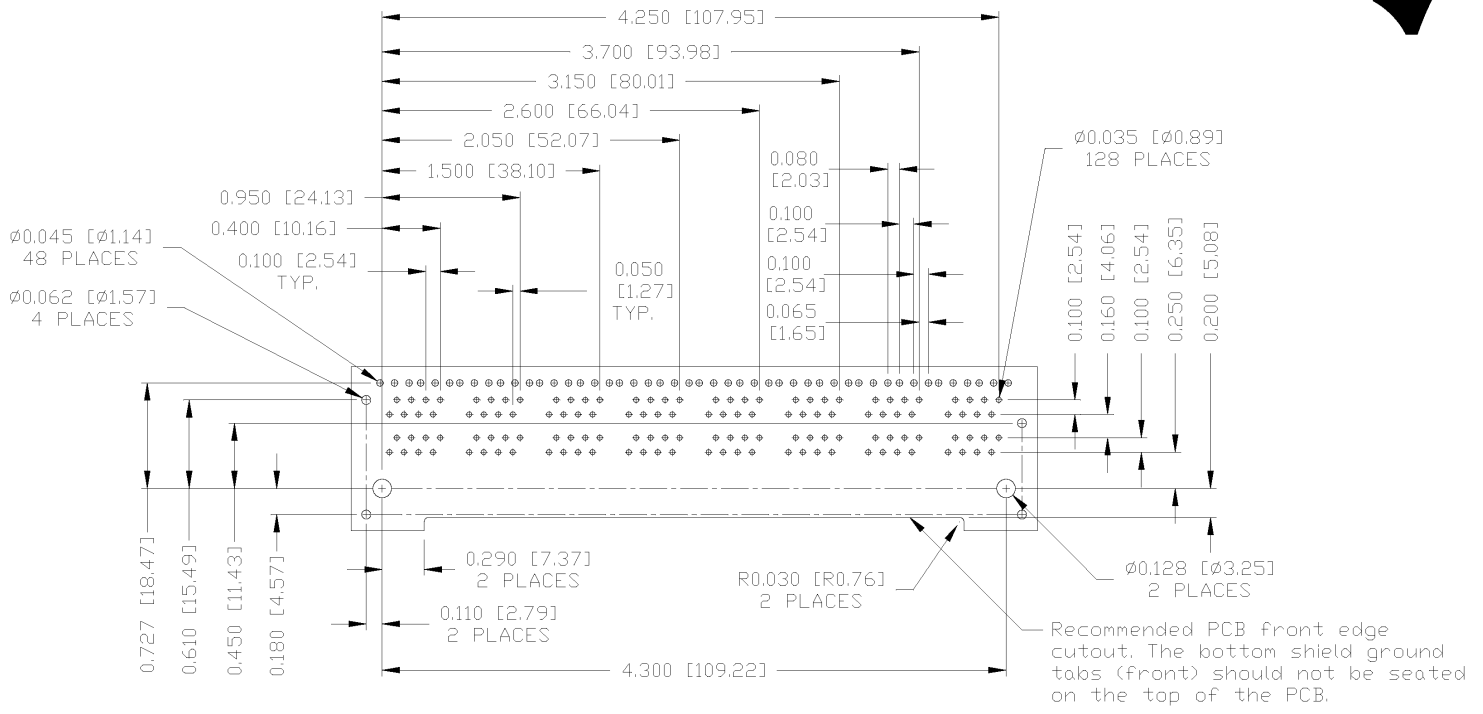

SUGGESTED FOOTPRINT
 (COMPONENT SIDE VIEW)

ORIGINATED BY	DATE	TITLE	PART NO. / DRAWING NO.	STANDARD DIM. TOL. IN INCH	[] METRIC DIM. AS	REFERENCE
QIN/BILL	01-18-07	2X8 MagJack® with LED 0810-2H8R-28-F	08102H8R28-F	.X	UNIT : INCH [mm]	REV. : A
DRAWN BY	DATE		FILE NAME	.XX	SCALE : N/A	SIZE : A4
TING	01-18-07		08102H8R28-FA.DWG	.XXX	±0.004	PAGE : 5



THE INFORMATION CONTAINED HEREIN IS CONSIDERED "PROPRIETARY" TO BEL FUSE INC. AND SHALL NOT BE COPIED, REPRODUCED OR DISCLOSED WITHOUT THE WRITTEN APPROVAL OF BEL FUSE INC.

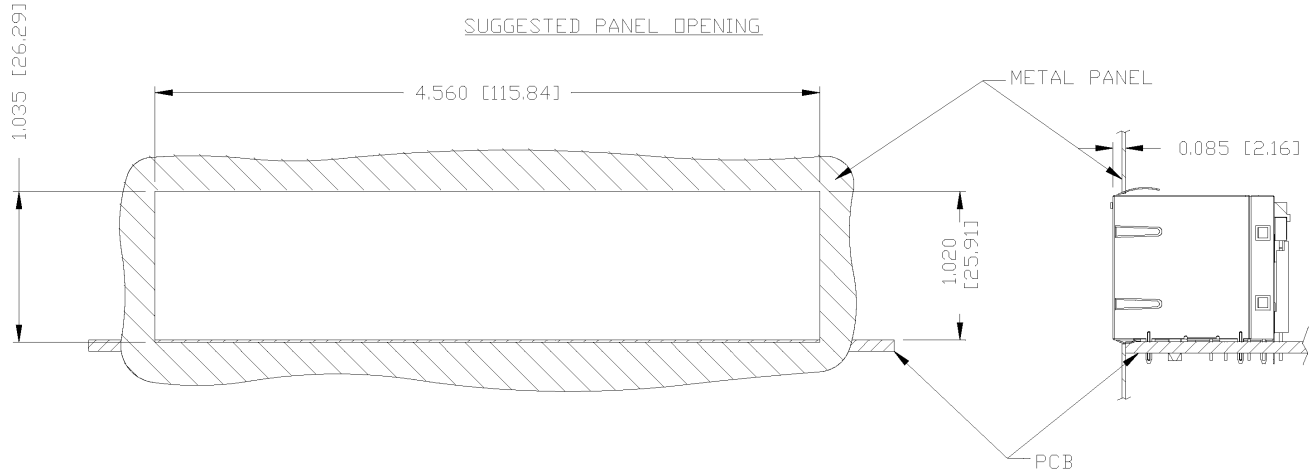

NOTES:

THE DISTANCE OF PANEL INSIDE SURFACE RELATIVE TO FRONT SURFACE OF PART IS ONLY A SUGGESTION. IN CASE THIS DISTANCE IS DIFFERENT, THE REQUIRED PANEL OPENING DIMENSIONS CHANGE ACCORDINGLY.

PACKING INFORMATION

PACKING TRAY : 0200-9999-B2 (TOP)
 0200-9999-B3 (BOTTOM)

PACKING QUANTITY : 10 PCS FINISHED GOODS PER TRAY
 7 TRAYS (70 PCS FINISHED GOODS) PER CARTON BOX

NOTE : CARDBOARDS ARE PLACED BETWEEN LAYERS OF PACKING TRAY INSIDE CARTON BOX
 (INCLUDE THE UPPERMOST AND LOWERMOST TRAY)

ORIGINATED BY	DATE	TITLE	PART NO. / DRAWING NO.	STANDARD DIM. TOL. IN INCH	[] METRIC DIM. AS REFERENCE
QIN/BILL	01-18-07	2X8 MagJack® with LED 0810-2H8R-28-F	08102H8R28-F	.X	UNIT : INCH [mm] REV. : A
DRAWN BY	DATE		FILE NAME	.XX	SCALE : N/A SIZE : A4
TING	01-18-07		08102H8R28-FA.DWG	.XXX ±0.004	PAGE : 6

